

NAD

**SERVICE
MANUAL**

7155

AM/FM STEREO RECEIVER

NAD 7155 SERVICE MANUAL

NOTE: This manual covers all versions.

A: U.S.A.

A1: Canada

B: U.K.

B1: Australia

C: EUROPE and others

C1: W-Germany

TABLE OF CONTENTS	PAGE
LOCATION MAP	2
SPECIFICATION	3 - 5
INTERNAL VIEW	6
SUGGESTED INSTRUMENTATION HOOKUP	7
FM ALIGNMENTS	8 - 11
AM ALIGNMENTS	12 - 13
AMPLIFIER ALIGNMENTS	14
AMPLIFIER P.C.B. LAYOUT DIAGRAM	16 - 17
SCHEMATIC DIAGRAM (AMPLIFIER SECTION)	18 - 19
TUNER P.C.B. LAYOUT DIAGRAM	20 - 21
SCHEMATIC DIAGRAM (TUNER SECTION)	22 - 23
WIRING DIAGRAM	24 - 25
EXPLODED VIEW PARTS LIST	26 - 28
EXPLODED VIEW	29
ELECTRICAL PARTS LIST	30 - 34

REAR PANEL

- 1. AC Line Cord.
- 2. AC Convenience Outlets (Not in European models)
- 3. Speakers A.
- 4. Speakers B.
- 5. Antenna Terminals.
- 6. AM Rod Antenna.
- 7. Phono Ground.
- 8. MM/MC.
- 9. Phono Input.
- 10. Phono Capacitance.
- 11. CD/Aux Input.
- 12. Tape 1 Rec/Play.
- 13. Tape 2 Rec/Play.
- 14. Preamp Out, Main In.
- 15. Soft Clipping.
- 16. Speaker Impedance.
- 17. Bridging.

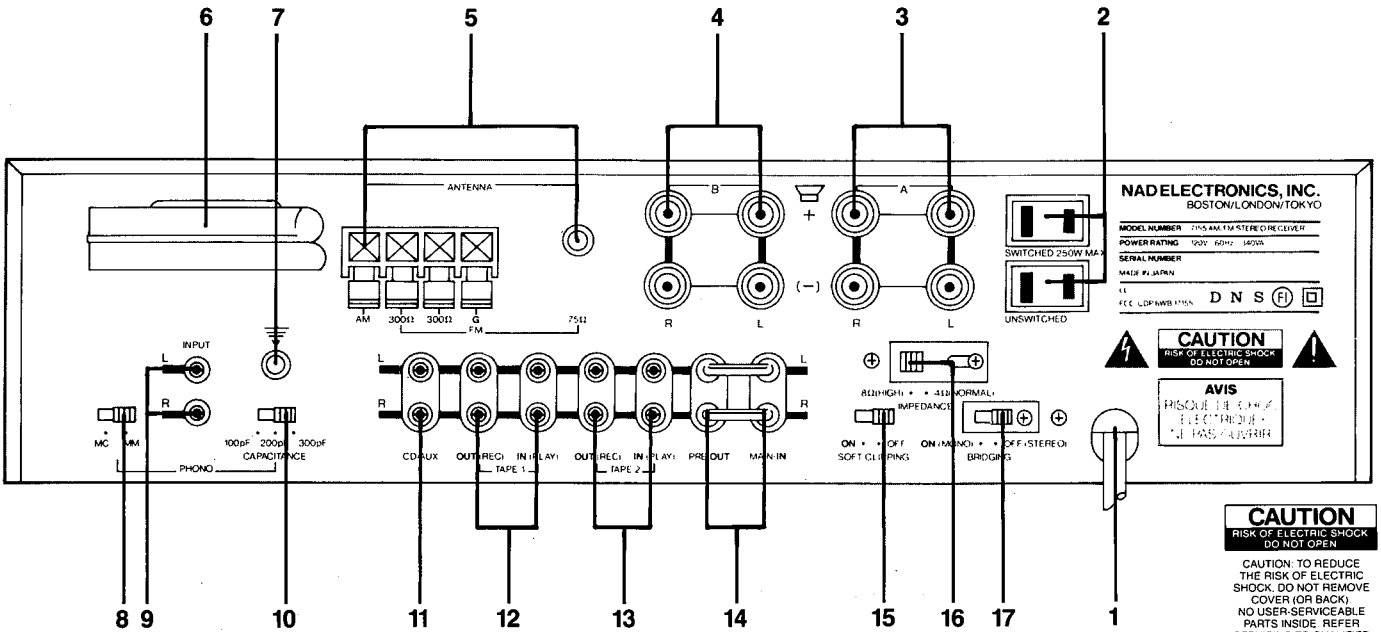

FRONT PANEL

- 1. Power.
- 2. Phones.
- 3. Speaker Selector.
- 4. Bass.
- 5. Treble.
- 6. Bass EQ.
- 7. Infrasonic Filter Defeat.
- 8. Mono.
- 9. Dyn Sep Defeat.
- 10. Recording Input Selector.
- 11. Listen Input Selector.
- 12. Low Level.
- 13. Loudness Compensation.
- 14. Volume/Balance.
- 15. Tuning Display.
- 16. Status Indicators.
- 17. Pre-sets.
- 18. Enter.
- 19. AM/FM.
- 20. Up/Down Tuning.
- 21. Search.

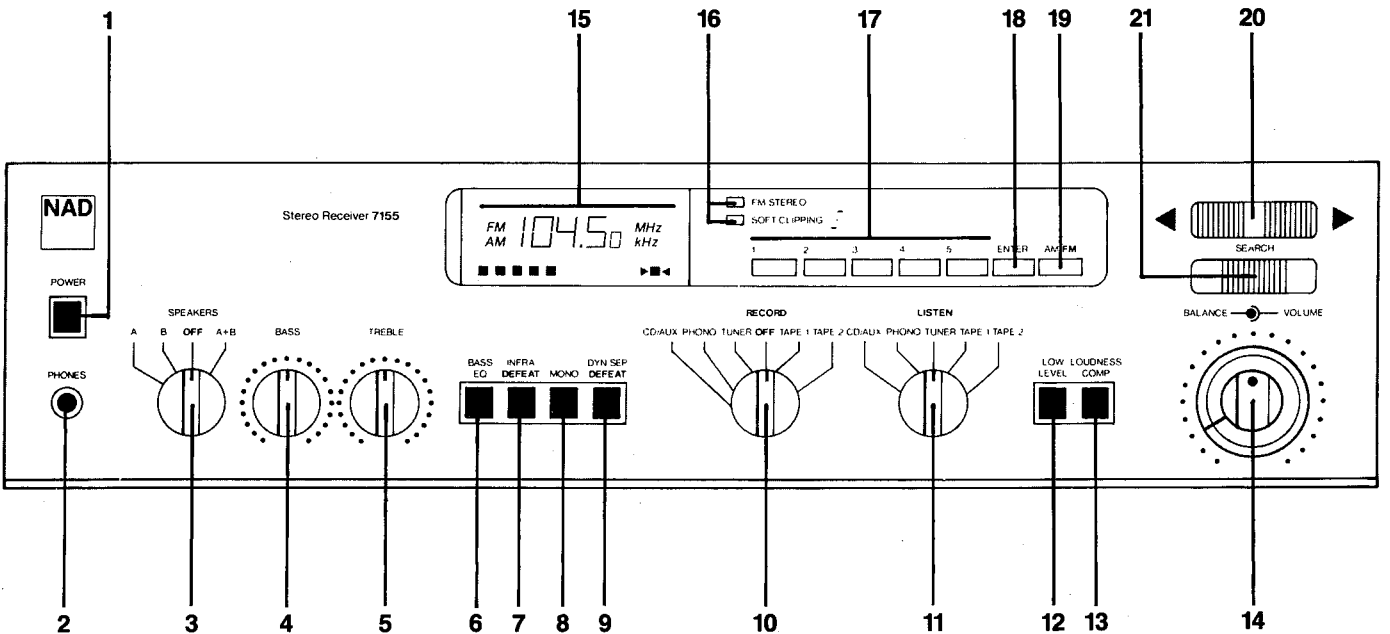

SPECIFICATIONS

NOTE: Measurements referenced to 8 ohms are taken with the Speaker Impedance Selector set to "8 ohm (High)". Measurements for 4 and 2 ohms are taken with the impedance selector at "4 ohm (Normal)". Specifications are measured in accordance with EIA Standard RS-490 (IHF A-202) for amplifiers and ANSI-IEEE Standard 185 (1975) (IHF T-200) for tuners. Tuner sensitivity is measured via 75 ohm coaxial input and converted to equivalent 300 ohm values.

Power Amplifier Section, Stereo Mode

	All versions except USA.	USA version only.
CONTINUOUS AVERAGE POWER OUTPUT INTO 8 OHMS (min. RMS power per channel into 8 ohms, 20 Hz - 20 kHz, both channels driven, with no more than the rated distortion).	55 W (17.4 dBW)	55 W (17.4 dBW)
Rated distortion (THD), 20 Hz - 20 kHz.	0.03 %	0.03 %
Clipping power (max. continuous power per channel).	8 ohms: 65 W 4 ohms: 75 W	75 W 90 W
IHF dynamic headroom at 8 ohms.	+ 2.6 dB	+ 3 dB
IHF dynamic power (max. short-term power per channel).	8 ohms: 100 W 4 ohms: 100 W 2 ohms: 130 W	110 W 130 W 150 W
Slew factor.	> 50	
Slew rate.	20 V/ μ sec.	
Damping factor (ref. 8 ohms, at 50 Hz).	> 50	
Input impedance.	22 k ohms.	
Input sensitivity for 1 W/55 W out.	0.13 V/0.95 V	
Power amp. gain.	26.8 dB.	
THD (Total Harmonic Distortion, 20 Hz - 20 kHz, from 250 mW to rated output).	< 0.03 %	
SMPTE I.M. (Intermodulation Distortion 60 Hz : 7 kHz, 4 : 1, from 250 mW to rated output).	< 0.03 %	
IHF I.M. (CCIR IM Distortion, 19 to 20 kHz at rated output).	< 0.03 %	

Bridged (Monophonic) Mode

CONTINUOUS AVERAGE POWER OUTPUT INTO 8 OHMS (min. RMS power into 8 ohms, 20 Hz - 20 kHz, with no more than the rated distortion).	125 W (21 dBW)	150 W (22 dBW)
IHF Dynamic Headroom at 8 ohms.	+ 2.5 dB	
Dynamic power (max. short-term output, 8 ohms).	250 W	

Preamplifier Section

Phono Input

Input impedance,	MM:	R 47 k ohms C 100/200/320 pF
	MC:	R 100 ohms C 1000 pF
Input sensitivity (1 kHz),	MM:	0.33 mV for 1 W out. 2.5 mV for 55 W out.
	MC:	0.02 mV for 1 W out. 0.15 mV for 55 W out.
Input overload at 20 Hz/1 kHz/20 kHz.	MM:	27 mV/230 mV/2 V.
	MC:	1.2 mV/12 mV/88 mV.
THD (20 Hz - 20 kHz) and IM Dist. at +30 dB level.		< 0.04 %
RIAA response accuracy.		± 0.5 dB.
S/N ratio, IHF A-weighted, with cartridge connected.	MM:	80 dB re 5 mV.
	MC:	80 dB re 0.5 mV.

Line Level Inputs (Aux., Tape)

Input Impedance.	R 10 k ohms; C 220 pF.
Input sensitivity.	20 mV for 1 W out. 150 mV for 55 W out.
Maximum input signal.	> 10 V
Signal to noise ratio, A-weighted.	88 dB re 1 W. 103 dB re 55 W.
Frequency response, 20 Hz - 20 kHz.	± 0.5 dB.

Outputs

Preamp output impedance.	800 ohms.
Maximum output level.	10 V.
Tape output impedance.	1000 ohms (buffered).
Tape output infrasonic filter.	– 3 dB at 15 Hz, 12 dB/octave.

Controls

Treble.	± 7 dB at 10 kHz.
Bass.	± 7 dB at 100 Hz.
Speaker equalization.	+ 3 dB at 70 Hz. + 6 dB at 32 Hz.
Infrasonic filter.	– 3 dB at 15 Hz, 12 dB/octave.
Audio muting (low level).	– 20 dB.

FM Tuner Section

Input sensitivity		50 μ sec. deemphasis	75 μ sec.
	Mono, -30 dB THD + N:	10.3 dBf. (1.8 μ V/300 ohms)	9.8 dBf. (1.7 μ V/300 ohms)
	Mono, 50 dB S/N:	15.8 dBf. (3.2 μ V)	13.2 dBf. (2.5 μ V)
	Stereo, 50 dB S/N:	33.2 dBf. (25 μ V)	32 dBf. (22 μ V)
	Stereo, 60 dB S/N:	43.1 dBf. (78 μ V)	42 dBf. (70 μ V)
Capture ratio at 25, 45 & 65 dBf.		< 1.5 dB.	
AM rejection.		> 65 dB.	
Selectivity,	Alternate channel:	70 dB.	
	Adjacent channel:	8 dB.	
Image rejection.		85 dB.	
R. F. intermodulation.		70 dB.	
I. F. rejection.		90 dB.	
SCA rejection.		70 dB.	
Subcarrier suppression (19 + 38 kHz).		60 dB.	
THD at 100 % modulation,		1 kHz	100 Hz - 6 kHz
	Mono:	0.09 %	0.2 %
	Stereo:	0.09 %	0.3 %
Signal to noise ratio, A-weighted, 65 dBf.	Mono:	82 dB.	
	Stereo:	75 dB.	
		(typ. 80 dB at 75 dBf)	
Frequency response, 30 - 15 kHz.		\pm 0.5 dB.	
Stereo separation (Dyn Sep off),	1 kHz:	50 dB.	
	30 Hz - 10 kHz:	40 dB.	

AM Tuner Section

Usable sensitivity.	300 μ V/meter.
Selectivity.	35 dB.
Image rejection.	50 dB.
I. F. rejection.	50 dB.

Physical Specifications

Dimensions (width x height x depth).	42 x 10.8 x 38 cm. 16.5 x 4.25 x 15 in.
Net weight.	9.18 Kg./20 lb. 4 oz.
Shipping weight.	10.6 Kg./23 lb. 6 oz.
Power consumption.	50/60 Hz at 110, 120, 220 or 240 VAC. 340 W.

INTERNAL VIEW

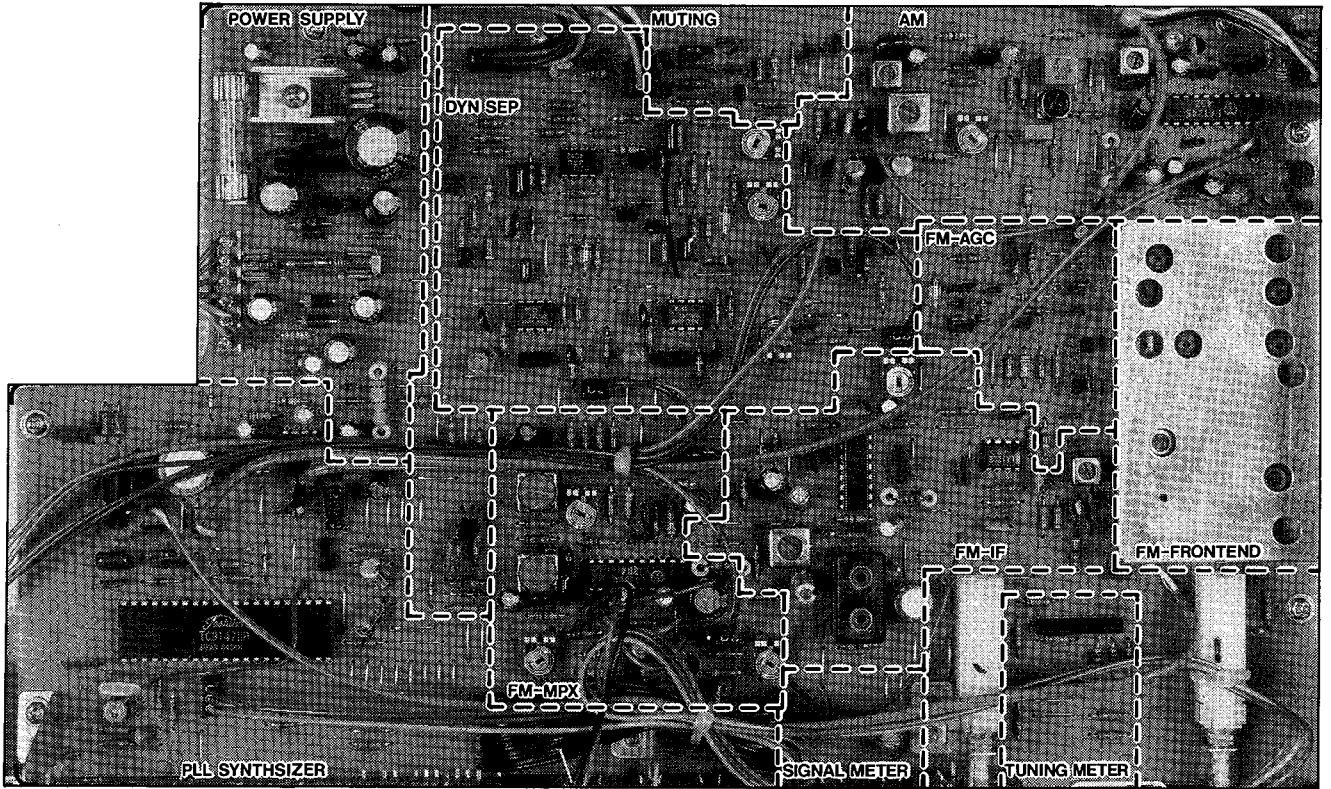

SUGGESTED INSTRUMENTATION HOOKUP

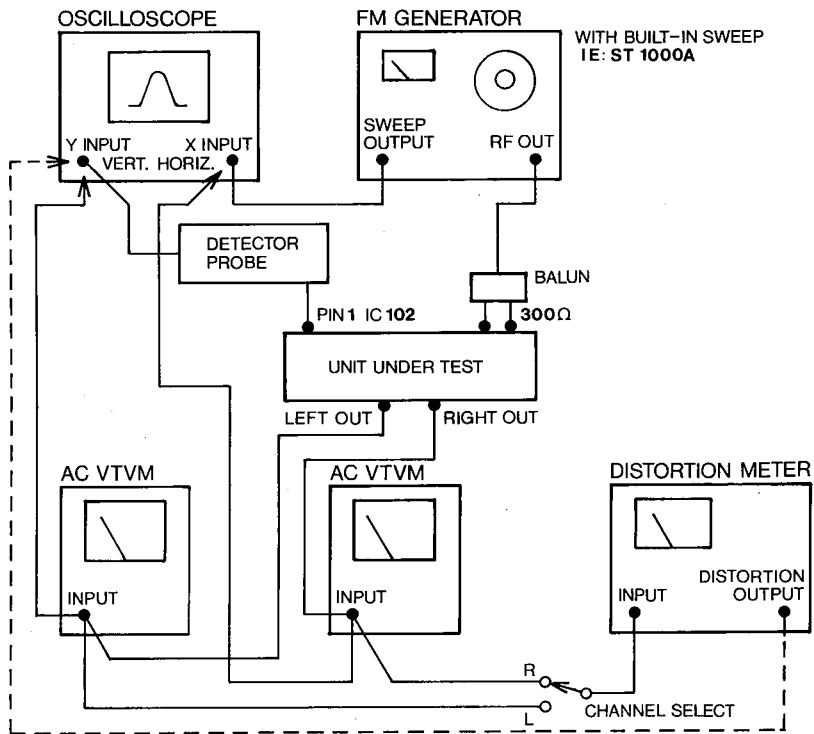
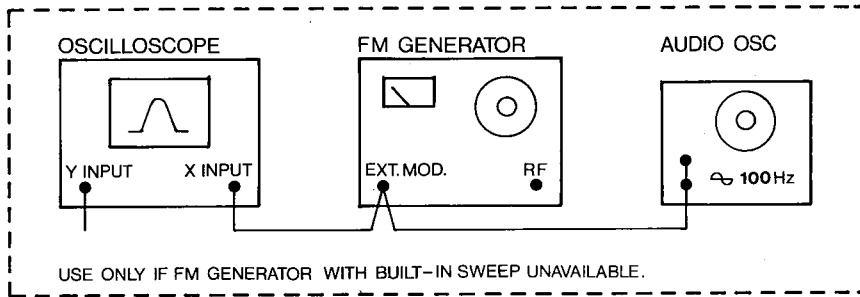

SCHEMATIC DIAGRAM OF DETECTOR PROBE

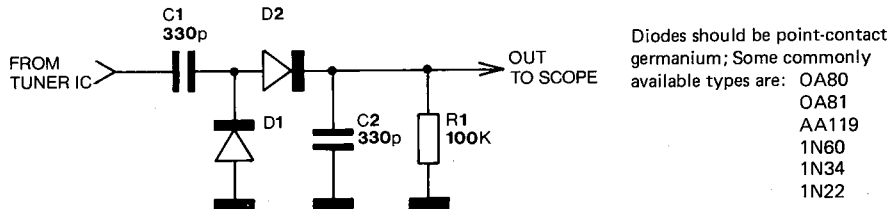

PICTORIAL DIAGRAM OF DETECTOR PROBE

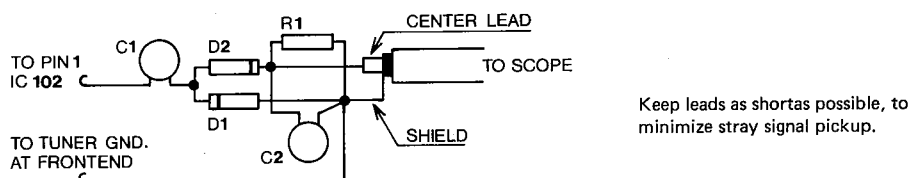

FM ALIGNMENTS

NECESSARY INSTRUMENTATION

FM GENERATOR (less than 0.05% THD)

STEREO GENERATOR (less than 0.05% THD, more than 50 dB sep.)

AUDIO GENERATOR (not necessary if FM generator has built in sweep; i.e., SOUND TECHNOLOGY ST 1000A and ST 1020A)

AC VTVM's (or one with a left/right switch)

THD ANALYZER (resolution less than 0.1%)

OSCILLOSCOPE (5mV or better sensitivity, X input capability)

FREQUENCY COUNTER

VOM or DMM (high impedance, must read in mV)

DETECTOR PROBE

IMPORTANT

While all FM generator output levels hereafter are referred to the 300 ohm input, 75 ohm input can be used, but be aware of possible equipment groundloops and divide the RF output levels by 2.

Before alignments commence set input selector and record selector to tuner and release mono dyn sep defeat switches (out).

FRONTEND

Alignment of frontend should only be necessary after repair to frontend or crystal oscillator circuits (pin 2 and 3 on IC 110).

A TUNING VOLTAGE (OSCILLATOR)

It is essential to check tuning voltage before aligning the rest of the frontend.

- 1 Connect DMM between ground and TP 102.
- 2 Tune to 108 MHz and adjust C 20 if voltage is incorrect.
SPECIFICATION $24.7V \pm 0.5V$
- 3 Tune to 88 MHz and read voltage. Adjust L 6 if voltage is incorrect.
SPECIFICATION $3.6V \pm 0.5V$
- 4 Repeat step 2 and 3 until readings are within tolerances.

B RF ADJUSTMENT (TRACKING)

- 1 Connect RF generator to 300 ohm antenna input and detectorprobe to pin 1 IC 102 with ground to tunershield. Adjust sensitivity of oscilloscope to maximum (5mV or better) and modulate FM generator sweep ± 300 kHz or more.
- 2 Set tuner to 105 MHz, enter into preset 5, and tune generator so that curve appears on oscilloscope. Turn down RF input level so that curve covers approximately 1/2 of oscilloscope display.
- 3 Adjust C 3, C 9, C 11 and C 15 to maximum curve height while reducing RF input to keep entire curve on display.
- 4 Set tuner to 90 MHz, enter into preset 1, and tune generator so that curve appears on oscilloscope display.
- 5 Adjust L 1, L 2, L 3 and L 4 to maximum curve height.
- 6 Repeat steps 2, 3, 4 and 5 (use preset 1 and 5) until both frequencies are at maximum curve height.

NOTE: 105 MHz curveheight is typically slightly stronger than 90 MHz.

C IF ADJUSTMENT

- 1 Set tuner to approximately 98 MHz (the tuner must be tuned to an unoccupied frequency) enter into preset 3, and tune FM generator to display a curve on oscilloscope.
- 2 Adjust L 5 and L 101 to maximum and symmetrical curve on the display, using as little input as possible.

NOTE: Maximum input 500 μV , typical curveheight 4 mV at 150 μV and 15 mV at 300 μV .

- D DETECTOR COARSE ADJUSTMENT (OPTIONAL, NEEDED ONLY IF DETECTOR WAS REPAIRED)**
- 1 Reduce sweep modulation level to ± 75 kHz and set input level to $300 \mu\text{V}$.
 - 2 Adjust FM generator frequency so that both legs of the inverted U-shaped curve are equally high on the display. The curve should be almost perfectly symmetrical.
 - 3 Disconnect detectorprobe from tuner and oscilloscope. Connect either of the tape 1 rec. outputs to the oscilloscope.
 - 4 The oscilloscope should now display a diagonal line. Adjust L 102 primary (closest to IC 102) to maximum curveheight and L 102 secondary to minimum curve height and straightest possible line. Go back and forth between primary and secondary till both are peaked.

NOTE: Both the cores should be within 1.5mm from the top of the form.

E DETECTOR ALIGNMENT (FINAL)

- 1 Disconnect detectorprobe and connect tape 1 rec. output to VTVM's, oscilloscope and distortion analyzer.
- 2 Switch stereo generator to 1 kHz 100% (± 75 kHz) mono modulation and oscilloscope to normal internal sweep 0.2 mS and 0.5 V/cm sensitivity.
- 3 Detector reference frequency.

Reduce FM generator output level while monitoring THD from left channel. When THD increases to 3%, fine tune the FM generator frequency to minimum THD. Reduce FM generator output level and fine tune till no reduction in the 3% THD can be achieved by fine tuning. Use this frequency for all the following detector, MPX and DYN SEP adjustments.

NOTE: The typical input level for this 3% THD should be $1.6 \mu\text{V}$ to $2.3 \mu\text{V}$. This is done only to "line up" the frequency from the generator to the tuner's frequency.

If IHF usable sensitivity (-30 dB THD + N = 3.16%) is to be verified, a proper IHF bandpass-filter must be used.

- 4 Connect DMM across TP 104 (negative) and TP 105 (positive). Set FM generator output to $1000 \mu\text{V}$
- 5 Adjust L 102 primary (closest to IC 102) for 0 V on DMM.
TOLERANCE ± 50 mV
- 6 Adjust L 102 secondary for lowest THD.
SPECIFICATION less than 0.1%
- 7 Repeat steps 3, 5 and 6 till no further improvements. Record the DMM's final reading for use later in the adjustments. (1 - 3)

F AUTOSEARCH LEVEL

- 1 Connect DMM between ground and TP 107.
- 2 Increase FM generator level upwards from 0 and adjust R 107 "MUTE" so that DMM reading goes from 0 V to approximately 4.8 V at $10 \mu\text{V}$ input.
TOLERANCE $\pm 2 \mu\text{V}$

G STEREO DECODER, MPX FILTERS.

- 1 VCO
Connect a frequency counter and a 200 k ohm resistor in parallel between ground and TP 108.
- 2 Set FM generator to $1000 \mu\text{V}$ output and no modulation.
- 3 Adjust R 164 "MPX VCO" for a 19000 Hz reading on the counter.
TOLERANCE ± 100 Hz
- 4 Disconnect frequency counter and resistor and depress DYN SEP defeat switch (in).
- 5 Stereo switch threshold.
Modulate FM generator 1 kHz 100% left only plus 19 kHz pilot 8 - 10%.

- Increase FM generator level upwards from 0 and adjust R 167 "ST SW" so that stereo light turns on and audio outputs, as watched on VTVM's and oscilloscope, switches to one channel only at 10 μV input level.

TOLERANCE + 5 μV

NOTE: When turning input level down the unit will switch into mono at a lower level, typically 7 μV .

7 Stereo separation.

Set FM generator output to 1000 μV , modulate left channel only.

- Adjust R 158 for minimum on right channel VTVM.

- Modulate FM generator right channel only and adjust R 158 for minimum on left channel VTVM.

- If the minimum in step 8 and 9 are different, adjust R 158 so that the readings are the same in both channels.

SPECIFICATION better than 50 dB separation

11 MPX filter

Turn off audiomodulation, leaving pilot tone only. Disable IHF filter, or external 19 kHz filter.

- Check 19/38 kHz suppression.

SPECIFICATION more than 60 dB

- If unit does not meet specification adjust FL 102 "MPX FILTER" on left channel and FL 103 "MPX FILTER" on right channel to minimum output.

NOTE: DO NOT ADJUST THE MPX FILTERS UNLESS NECESSARY, the cores are brittle and break easily.

- Release the DYN SEP DEFEAT switch (out).

DYN SEP ADJUSTMENTS.

- Turn R 256 "DYN SEP OFF", R 249 and 250 "DYN SEP" fully clockwise.

- DYN SEP separation effect.

Observe output from left channel with FM generator output level 1000 μV and modulated 1 kHz left channel only.

Reduce audiomodulation only from stereo generator so that left channel output is reduced by 6 dB (50% stereo modulation).

The 19 kHz pilot signal MUST REMAIN modulated 8 - 10%.

- Set FM generator output to 50 μV and adjust R 249 "DYN SEP" for -30 dB separation left to right channel.

TOLERANCE ± 2 dB

- Switch modulation to right channel only while maintaining the same modulation levels.

Adjust R 250 "DYN SEP" for -30 dB separation right to left channel.

TOLERANCE ± 2 dB

5 DYN SEP auto defeat level.

Set generator output to 200 μV and adjust R 256 "DYN SEP OFF" so that separation starts increasing when watching left channel VTVM. Adjust FM generator output up and down around 200 μV and make sure switching occurs around 200 μV .

TOLERANCE + 100 μV - 30 μV

SYNTHESIZER FREQUENCY

- Tune to a known accurate frequency source, i.e., broadcasting station or synthesized/digital display FM generator preferably in the midband 95 - 100 MHz.

- Connect DMM across TP 104 (negative) and TP 105 (positive).

- Adjust C 209 "FQ" so that DMM reads the same as recorded in E - 7.

TOLERANCE ± 10 mV

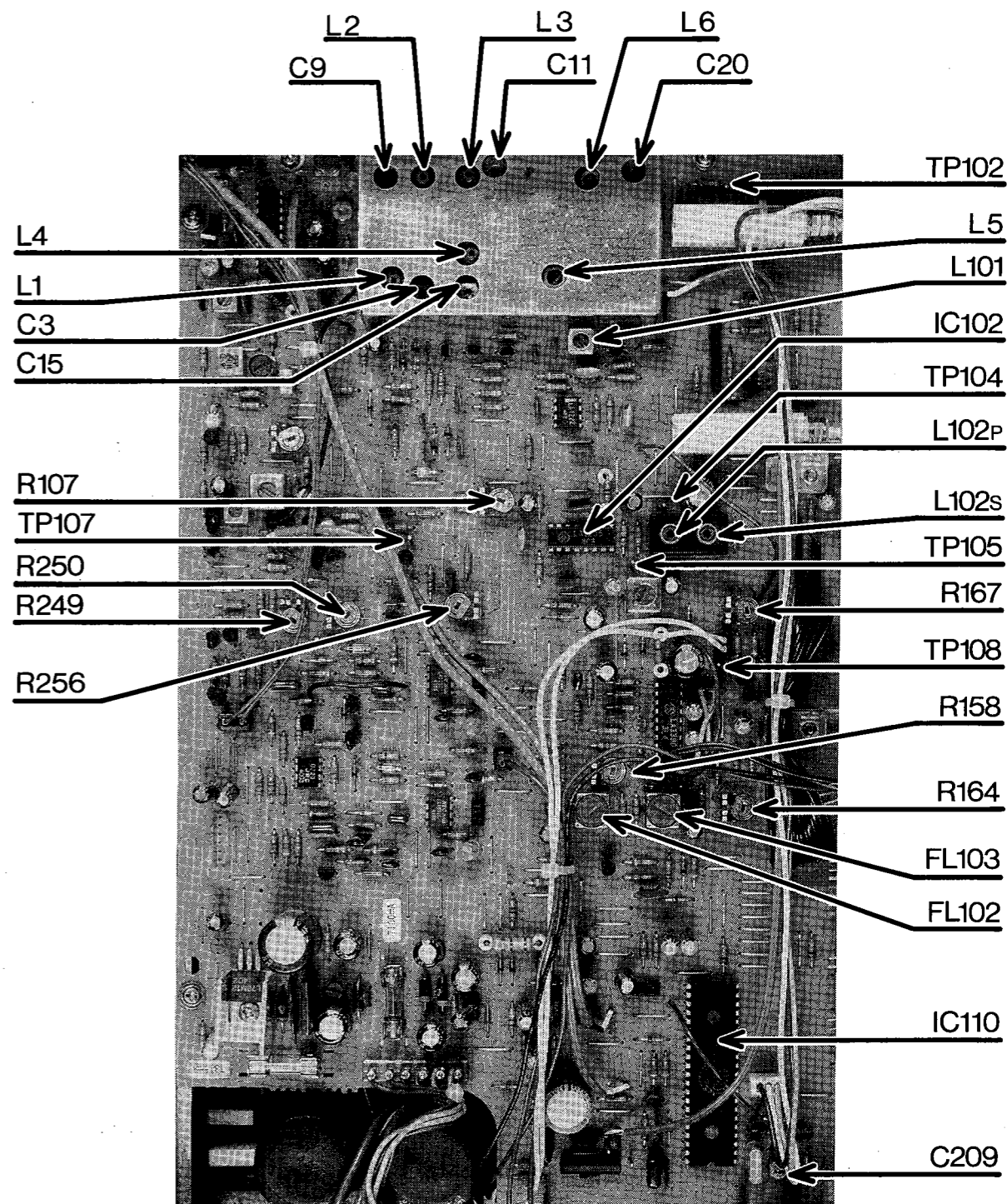

AM ALIGNMENTS

A OSCILLATOR.

- 1 Connect DMM to TP 101 and gnd.
- 2 Tune to 1710 kHz. Enter into preset 1. Adjust C 148 for reading of $31 \pm 0.5\text{VDC}$.
- 3 Tune to 520 kHz. Enter into preset 2. Adjust L 103 for reading of $1.8 \pm 0.1\text{ VDC}$.
- 4 Repeat steps 2 and 3 until within tolerances.

B ANTENNA, IF

- 1 Swing antenna away from chassis and peel back label (if present) to expose adjustment tab.
- 2 Connect DC voltmeter to centertap, R 208 and gnd.
- 3 Tune to station of moderate strength, near 600 kHz. Enter into preset 3. Adjust L 951 (move tab under label on antenna) for maximum reading on meter. (Use non-interactive tool, such as plastic or wooden stick.)
- 4 Adjust L 104 and L 106 for maximum reading on meter.
- 5 Tune station of moderate strength near 1400 kHz. Enter into preset 4. Adjust C 147 for maximum reading on meter.
- 6 Repeat steps 3 and 5 until no further improvement is seen.

C 9 kHz, 10 kHz WHISTLE FILTERS

- 1 Tune to quiet spot on the dial (a clear frequency)
- 2 Connect audio osc. to base, Q 117 (isolate with 0.1 - 1.0 μF capa.)
- 3 Connect AC VTVM (or scope) to TP 103.
- 4 Set audio osc. to 10 kHz ($\pm 50\text{ Hz}$) 1 V. Adjust FL 104 for minimum meter reading.
- 5 Set audio osc. to 9 kHz ($\pm 50\text{ Hz}$) 1 V. Adjust FL 105 for minimum meter reading.

D SIGNAL METER, AUTO STOP

R 208 controls signal strength indication and auto stop level, adjust only if necessary, to correct for scan stopping on excessively weak signals, or failure to stop on moderately strong ones.

NOTE: When finished, lock antenna bar adjustment with laquer (nail polish), re-install label.

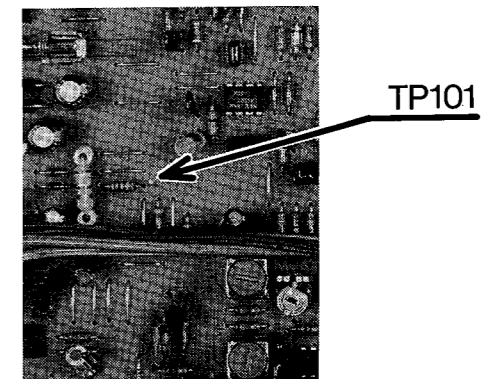
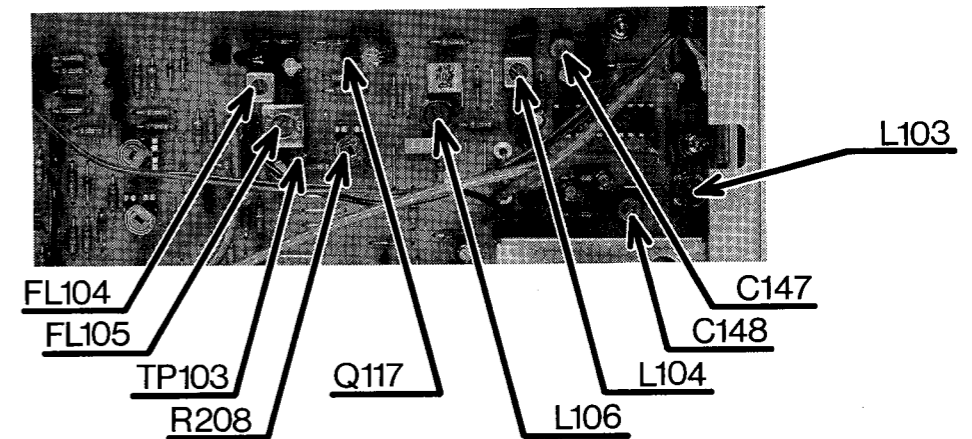
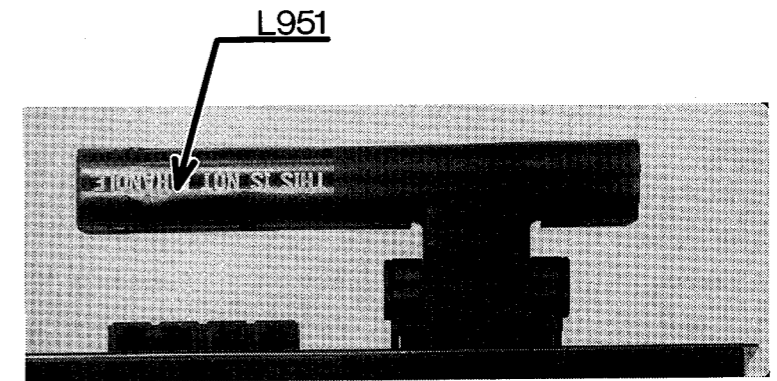

AMPLIFIER ALIGNMENTS

MEMO

- A IDLE (QUIESCENT) CURRENT
- 1 Connect mV meter (DVM) from TP 701 to TP 702, left chan. (from TP 751 to TP 752, right chan.)
 - 2 Adjust R 721, left chan. (R 771, right chan.) so that meter reading is 20 - 25 mVDC.
- NOTE: Reading may take a few minutes to stabilize; re-check after offset adjustment (next step.)
- B OFFSET (CENTERING) VOLTAGE:
- Adjust R 708. left (R 758, right) so that voltage at spkr. terminals is 0 ± 50 mVDC.
- NOTE: Perform these adjustments with no load, volume minimum.

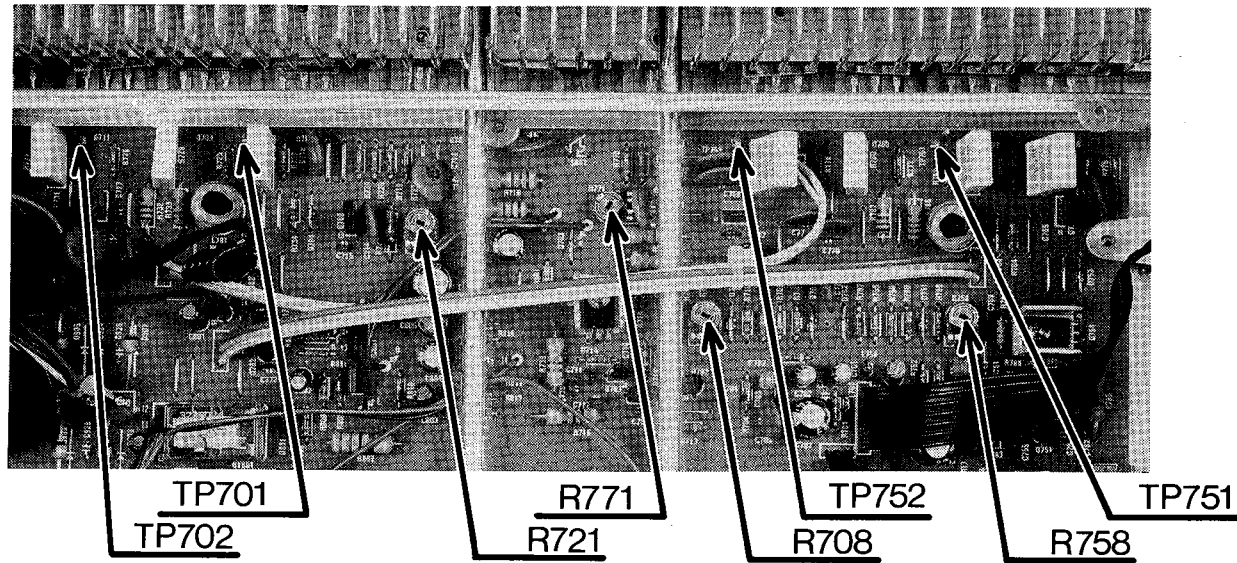

AMPLIFIER P.C.B. LAYOUT DIAGRAM

SPEAKER TERMINAL PCB

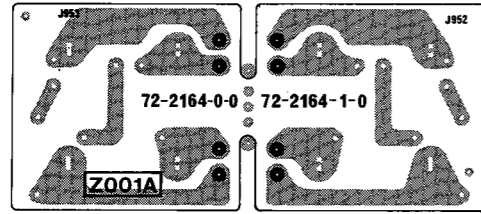

PHONO AMP. PCB

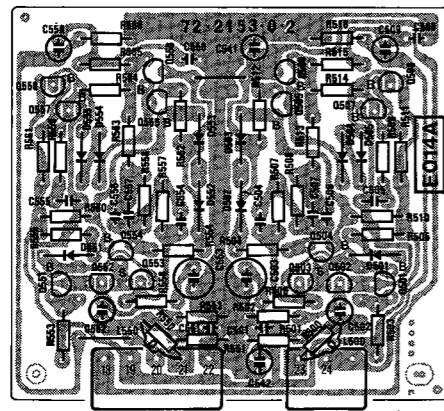

LED DISPLAY PCB



SPEAKER SWITCH PCB

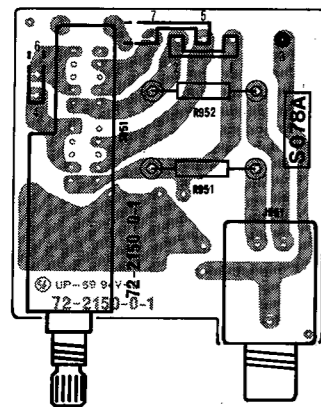

POWER SWITCH PCB

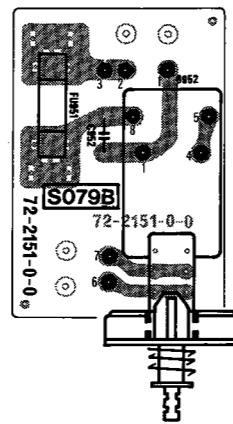

INPUT/OUTPUT PCB

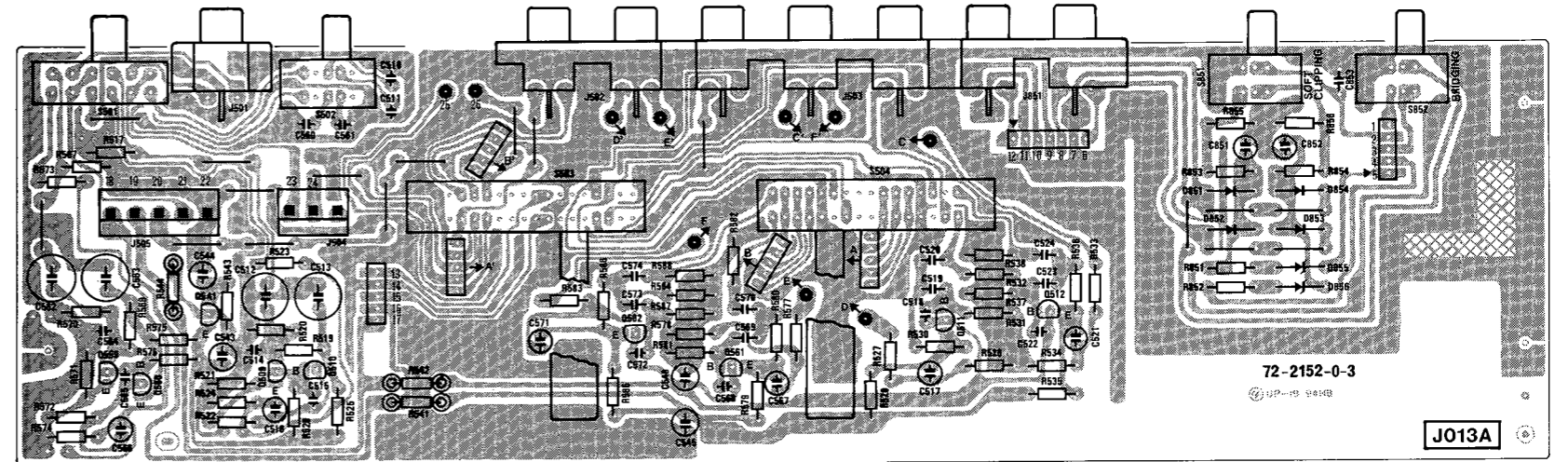

MAIN/CONTROL AMP. & POWER SUPPLY PCB

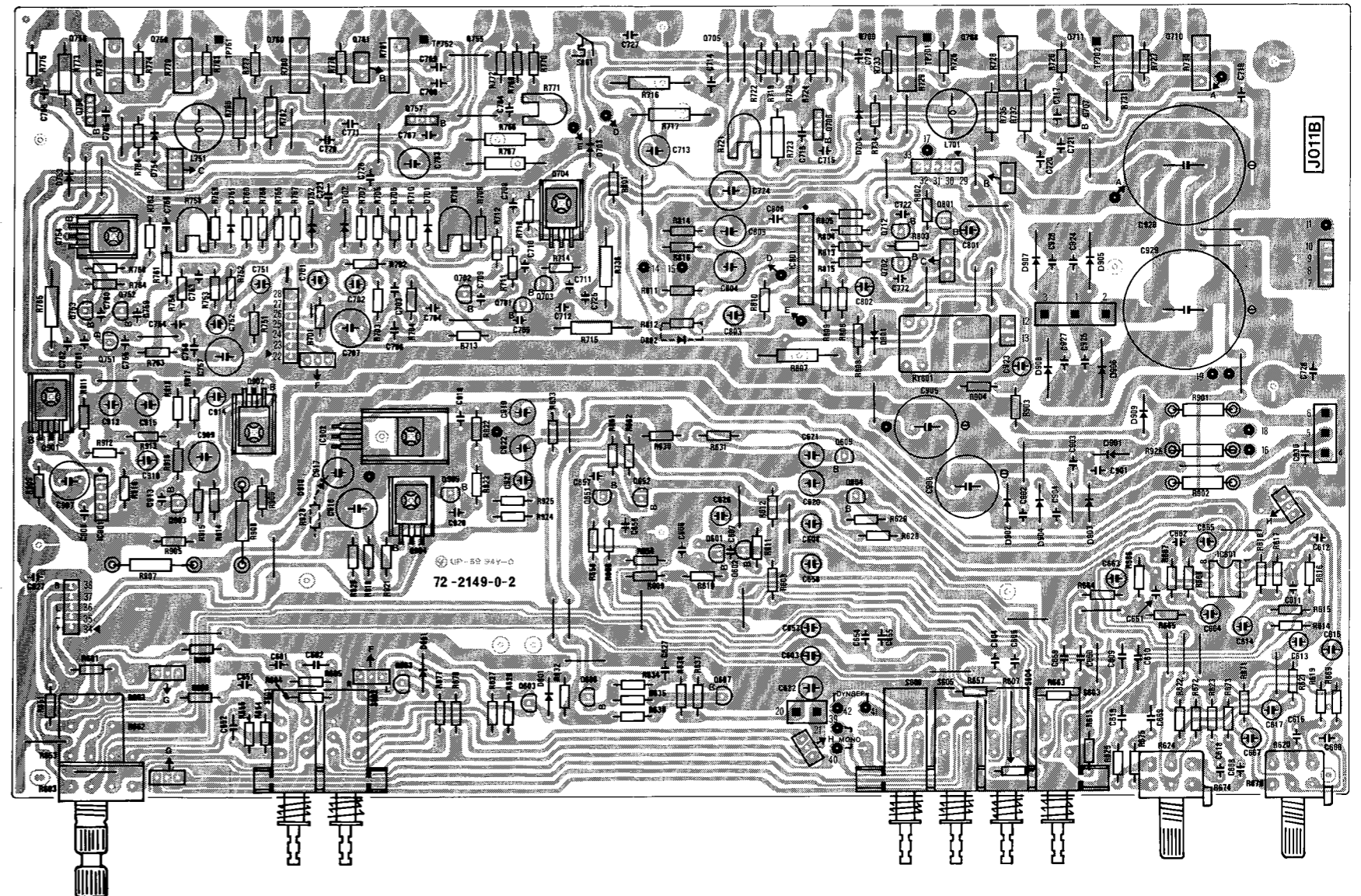

TUNER P.C.B. LAYOUT DIAGRAM

DISPLAY & PRESET SELECTOR PCB

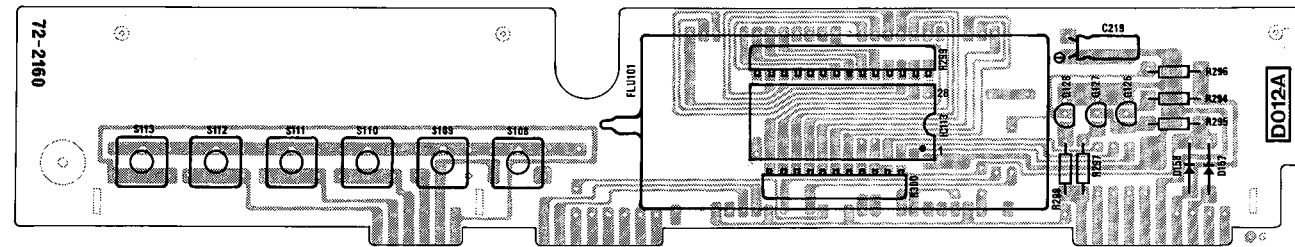

ANTENNA TERMINAL PCB

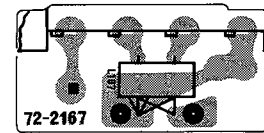

TUNER PCB

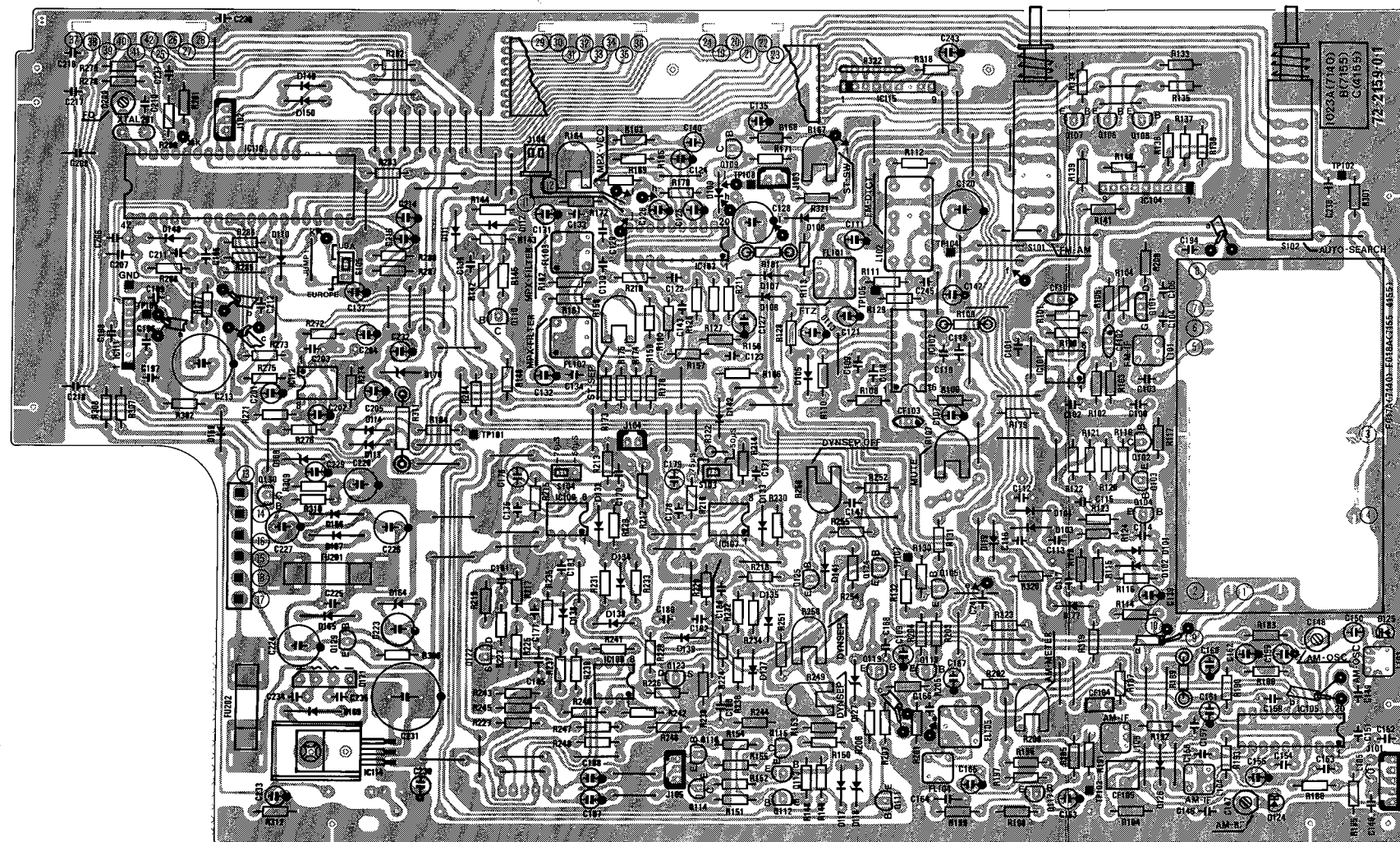

FRONTEND PCB

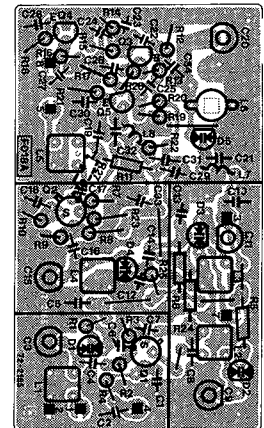

UP/DOWN PCB

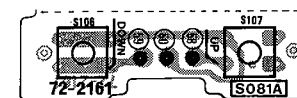

SCHEMATIC DIAGRAM NAD 7155 AMPLIFIER SECTION

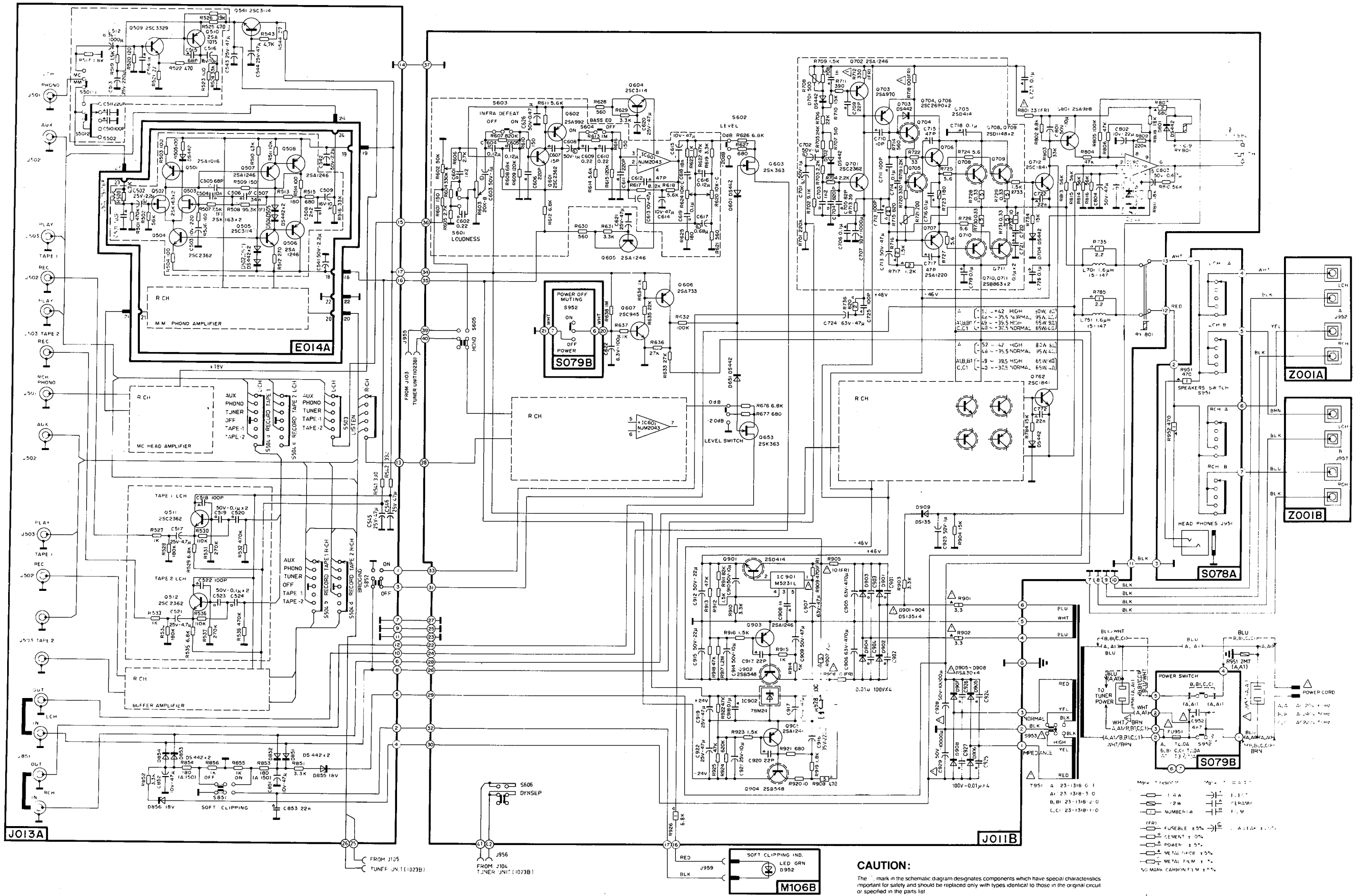

WIRING DIAGRAM

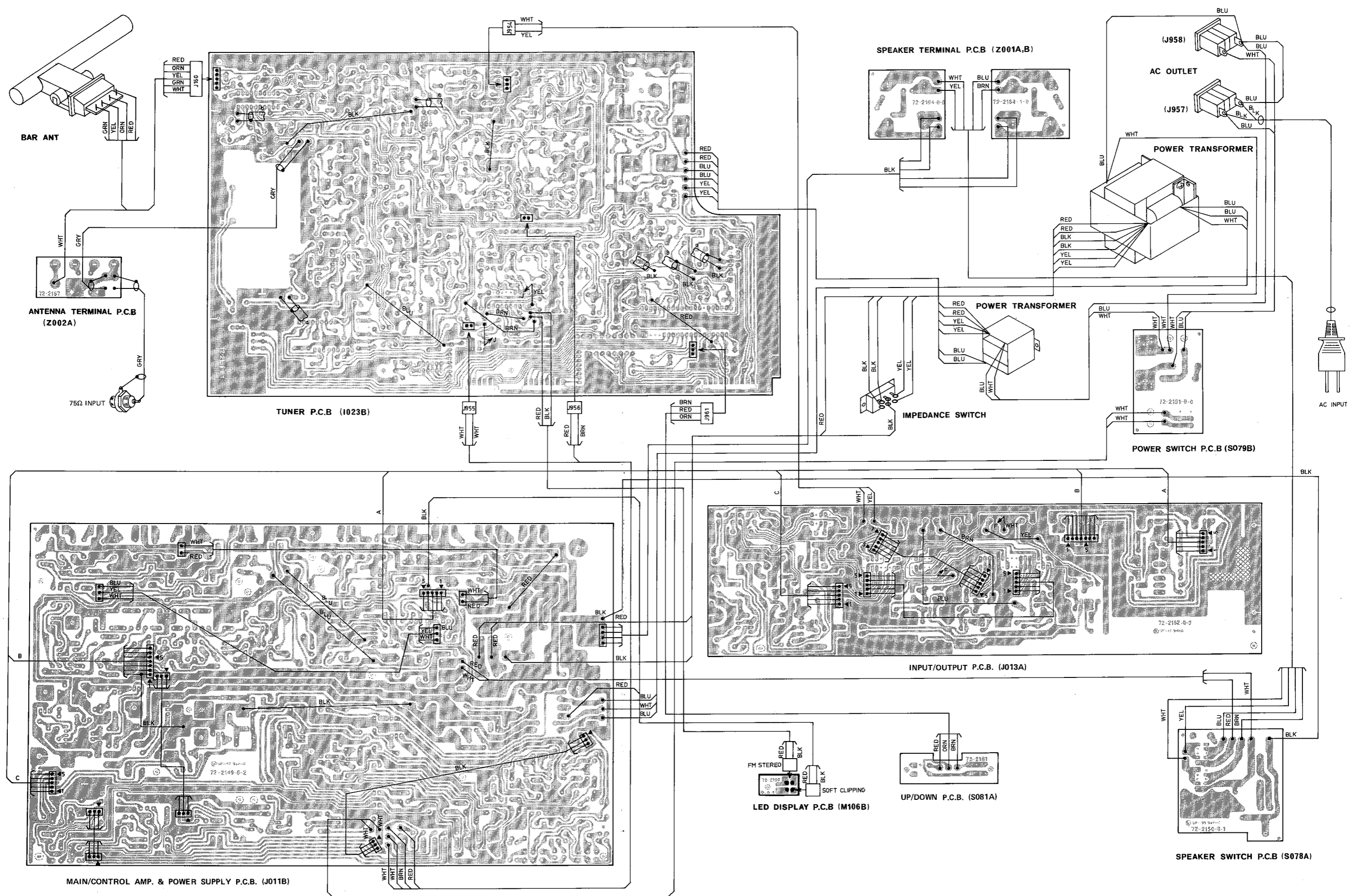

SCHEMATIC DIAGRAM NAD 7155 TUNER SECTION

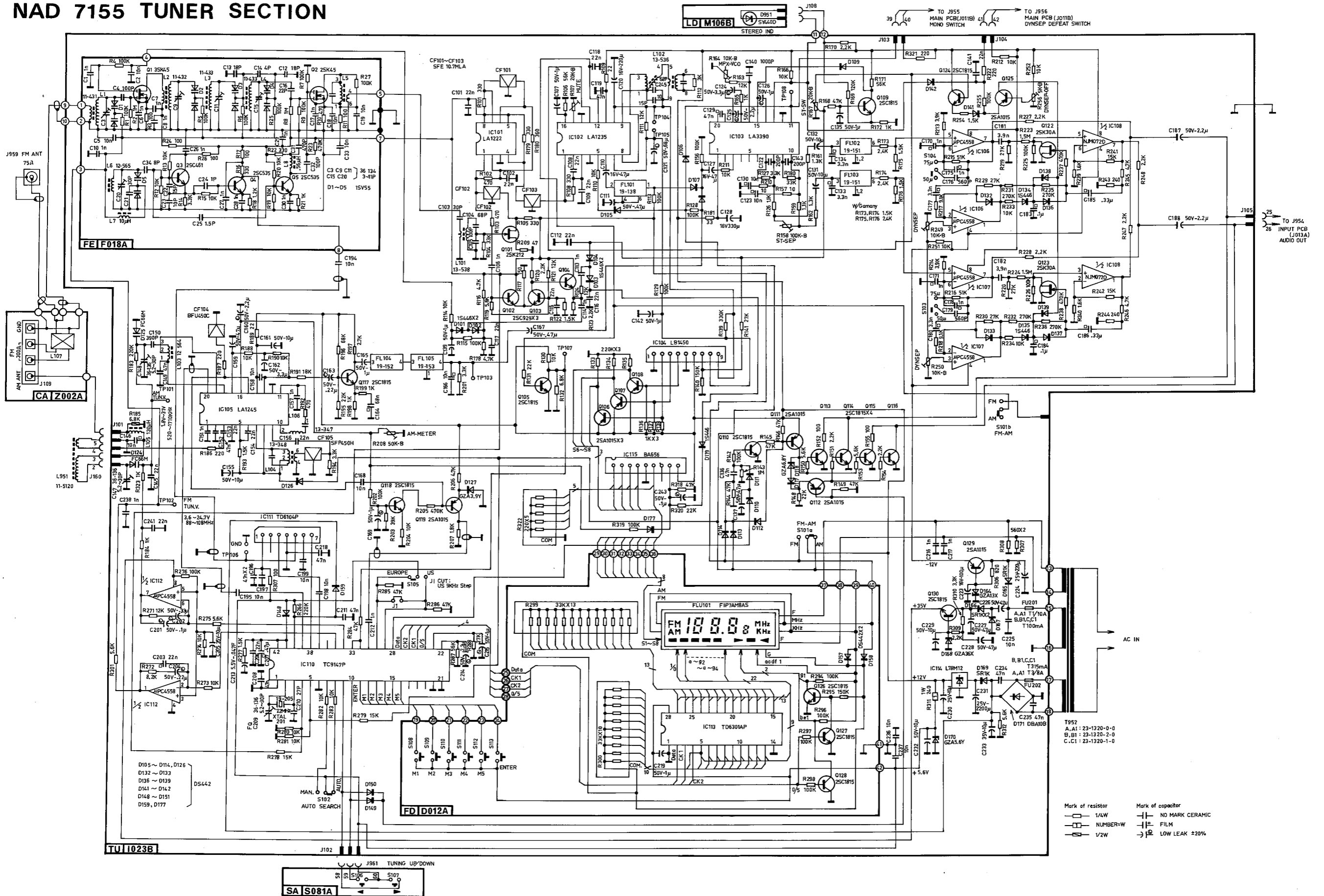

Mark of resistor
 1/4W
 NUMBER-W
 1/2W

Mark of capacitor
 NO MARK CERAMIC
 FILM
 LOW LEAK ±20%

EXPLODED VIEW PARTS LIST

Ref. No.	Parts No.	Descriptions
1	63-6272-0-0	FRONT PANEL
2	62-1105-0-0	PUSH BUTTON - SELECTORS
3	62-1105-1-0	PUSH BUTTON - ON/OFF
4	62-3465-0-0	PUSH BUTTON FRAME - SINGLE HOLE
5	62-3466-0-0	PUSH BUTTON FRAME - TWO HOLES
6	62-3468-0-0	PUSH BUTTON FRAME - FOUR HOLES
7	62-2317-0-0	ROTARY KNOB - TONE CONTROL/SELECTORS
8	62-2318-0-0	ROTARY KNOB - BALANCE
9	62-2319-0-0	ROTARY KNOB - VOLUME
10	62-3469-0-0	DISPLAY PANEL
11	62-1106-0-0	PUSH BUTTON - BLACK
12	62-1106-1-0	PUSH BUTTON - LIGHT BROWN
13	62-3471-0-0	PUSH BUTTON PLUNGER
14	62-1107-0-0	ROCKER BUTTON - UP/DOWN SEARCH
15	62-1108-0-0	PUSH BUTTON - AUTO SEARCH
16	88- 170-0-0	SPRING - PUSH BUTTON RETURN
17	63-5169-0-0	DISPLAY WINDOW
18	92-2102-0-0	FOOT - SNAP ON TYPE
	92-2103-0-0	FOOT - PLASTIC RIVET TYPE
19	63-1844-0-0	LABEL : THIS IS NOT A HANDLE.
20	63-1845-0-0	PLATE (POLYESTER)
26	71-2584-0-0	FRONT SUBCHASSIS
27	92-1175-0-0	INSULATOR (PVC) (B B1 C C1)
28	71-2586-0-0	SIDE CHASSIS (L)
29	71-2587-0-0	SIDE CHASSIS (R)
30	71-2588-0-0	SUBCHASSIS (FRONT TO REAR SUPPORT)
31	71-2589-0-0	SUBCHASSIS (LEFT TO RIGHT SUPPORT)
32	71-1891-0-0	THERMAL SWITCH CLAMP
33	92-1225-0-0	INSULATOR (PVC) (A A1 AC RECEPTACLE)
34	92-1223-0-1	LOCKING PLATE - IMPEDANCE SWITCH
35	92-1224-0-0	LOCKING PLATE - BRIDGING SWITCH
36	71-2596-0-0	REAR PANEL (A A1)
	71-2601-0-0	REAR PANEL (C C1)
	71-2601-1-0	REAR PANEL (B B1)
37	71-3107-0-0	CABINET
38	71-3104-0-0	BOTTOM COVER
44	23-1318-0-1	POWER TRANSFORMER (A)
	23-1318-1-0	POWER TRANSFORMER (C C1)
	23-1318-2-0	POWER TRANSFORMER (B B1)
	23-1318-3-0	POWER TRANSFORMER (A1)
45	23-1320-0-0	TUNER POWER TRANSFORMER (A)
	23-1320-1-0	TUNER POWER TRANSFORMER (C C1)
	23-1320-2-0	TUNER POWER TRANSFORMER (B B1)
	23-1320-3-0	TUNER POWER TRANSFORMER (A1)
46	85- 258-0-0	POWER CORD (A)
	85- 235-0-0	POWER CORD (C C1)
	85- 240-0-0	POWER CORD (B)
	85- 259-0-0	POWER CORD (B1)
	85- 260-0-0	POWER CORD (A1)
47	82-2161-0-0	RECEPTACLE (A A1)

Ref. No.	Parts No.	Descriptions
48	82-2162-0-0	F TYPE ANTENNA CONNECTOR (A A1)
	82- 293-0-0	DIN TYPE ANTENNA CONNECTOR (B B1 C C1)
50	81- 450-0-0	SLIDE SWITCH - IMPEDANCE SELECTOR (A B B1 C C1)
	81- 452-0-0	SLIDE SWITCH - IMPEDANCE SELECTOR (A1)
51	74-3104-0-0	HEAT SINK
52	82- 118-0-0	JUMPER CONNECTOR
53	65- 128-0-0	SHAFT - SELECTOR
54	62-3472-0-0	BUSHING FOR SHAFT SELECTOR
55	62-3474-0-0	JOINT FOR SHAFT SELECTOR
57	87-3242-0-0	GROUND TERMINAL
58	87-3243-0-0	STUD BOTTOM COVER SUPPORT
59	11-5120-0-0	AM BAR ANTENNA
60	62-3332-0-0	BUSHING - AC POWER CORD
61	63-1843-0-0	LABEL (CAUTION FOR FUSE) (A A1)
66	J013A	INPUT/OUTPUT PCB
66 - 1	82-2130-0-0	RCA CONNECTORS - SINGLE
66 - 2	82-2157-0-0	RCA CONNECTORS - DOUBLE
66 - 3	82-2159-0-0	RCA CONNECTORS - TRIPLE
66 - 4	81- 447-0-0	SLIDE SWITCH - SOFT CLIPPING & BRIDGING
66 - 5	81- 448-0-0	SLIDE SWITCH - PHONO CAPACITANCE SELECTOR
66 - 6	81- 449-0-0	SLIDE SWITCH - PHONO MM/MC SELECTOR
66 - 7	81- 184-0-0	ROTARY SWITCH - LISTEN SELECTOR
66 - 8	81- 185-0-0	ROTARY SWITCH - RECORD SELECTOR
66 - 9	84-3184-0-0	PCB CONNECTORS (MALE) - 3 POSITIONS
66 - 10	84-3201-0-0	PCB CONNECTORS (MALE) - 5 POSITIONS
67	J011B	MAIN/CONTROL AMP & POWER SUPPLY PCB
67 - 1	41- 686-0-0	ROTARY POTENTIOMETER - VOLUME
67 - 2	41- 685-0-0	ROTARY POTENTIOMETER - BASS & TREBLE
67 - 3	81-2321-0-0	FUNCTION SWITCH BANK (4 SWITCHES)
67 - 4	81-2323-0-0	FUNCTION SWITCH BANK (2 SWITCHES)
68	S078A	SPEAKER SWITCH PCB
68 - 1	82-2158-0-0	HEADPHONE JACK
68 - 2	81- 183-0-0	ROTARY SWITCH - LOUDSPEAKER SELECTOR
69	S079B	POWER SWITCH PCB
69 - 1	81-2227-0-0	POWER SWITCH (A A1)
	81-2245-0-0	POWER SWITCH (B B1 C C1)
69 - 2	71-1894-0-0	FUSE HOLDER (A A1)
	71-1246-0-0	FUSE HOLDER (B B1 C C1)
69 - 3		FUSE (A) - MDX-4 OR MSL-4
		FUSE (A1) - MDX-3*2/10 125V
		FUSE (B B1 C C1) - T2.0A 250V
70	Z001A/Z001B	SPEAKER TERMINAL PCB
70 - 1	82-2164-0-0	BINDINGPOST - LOUDSPEAKERS
71	M106B	LED DISPLAY PCB
72	F018A	FM FRONT-END PCB
73	I023B	TUNER PCB
73 - 1	71-1889-0-0	PCB SUPPORT
73 - 2	74- 388-0-0	HEAT SINK
73 - 3	81-2325-0-0	FM/AM SELECTOR SWITCH/AUTO SEARCH SWITCH
74	D012A	DISPLAY & PRESET SELECTOR PCB

EXPLODED VIEW

Ref. No.	Parts No.	Descriptions
74 - 1	7AM8AS	FLUORESCENT INDICATOR TUBE
74 - 2	81-2326-0-0	MOMENTARY SWITCH - PRE-SET & UP/DOWN
75	S081A	UP/DOWN PCB
76	Z002A	ANTENNA TERMINAL PCB
76 - 1	82-2163-0-0	CONNECTORS - ANTENNA TERMINAL
77	E014A	PHONO AMP PCB
77 - 1	84-3202-0-0	CONNECTORS (FEMALE) - 3 POSITIONS
77 - 2	84-3203-0-0	CONNECTORS (FEMALE) - 5 POSITIONS
80		TAPPING SCREW (PHILLIP'S HEAD 3 x 6 Cr)
81		TAPPING SCREW (PHILLIP'S HEAD 3 x 8 Cr)
82		TAPPING SCREW (PHILLIP'S HEAD 3 x 6 BLK)
83		TAPPING SCREW (PHILLIP'S HEAD 3 x 8 BLK)
84		TAPPING SCREW (WASHER HEAD 3 x 6 Cr)
85		MACHINE SCREW S (WASHER HEAD 3 x 6 Cr)
87		MACHINE SCREW S (PHILLIP'S HEAD 3 x 8 BLK)
88		MACHINE SCREW (PAN 3 x 6 Cr)
89		MACHINE SCREW (PHILLIP'S HEAD 3 x 8 BLK)
90		MACHINE SCREW S (PHILLIP'S HEAD 4 x 6 Cr)
91		RETAINING RING (E TYPE 5mm)
92		WASHER (PLAIN 4-10-0.8 Ni)
93		WASHER (TOOTHED LOCK B 4 Ni)
94		WASHER (TOOTHED LOCK B 3 Ni) (A A1)
95		NUT (HEXAGON M4-7-3.2 Cr)
96		TERMINAL LUG (A A1)
97		TAPPING SCREW (PAN 2.6 x 6 Cr)
98		MACHINE SCREW (PHILLIP'S HEAD 3 x 6 Cr)
99		CABINET SCREW WITH WASHER (4 x 6 BLK)
100		HEAD PHONE JACK NUT (HEXAGON 12-14-2)
101		WASHER (PLAIN 12-18-0.5)
102		SPEAKER SWITCH NUT (HEXAGON 7-10-2)
103		WASHER (PLAIN 7-12-0.5)
104		TONE CONTROLS NUT (HEXAGON 7-11-2)
105		VOLUME CONTROL NUT (HEXAGON 9-11-2)
106		WASHER (PLAIN 9-14-0.5)
107		F-CONNECTOR NUT (HEXAGON UNF 3/8-11-2)
108		TERMINAL LUG (MET 31-0107)

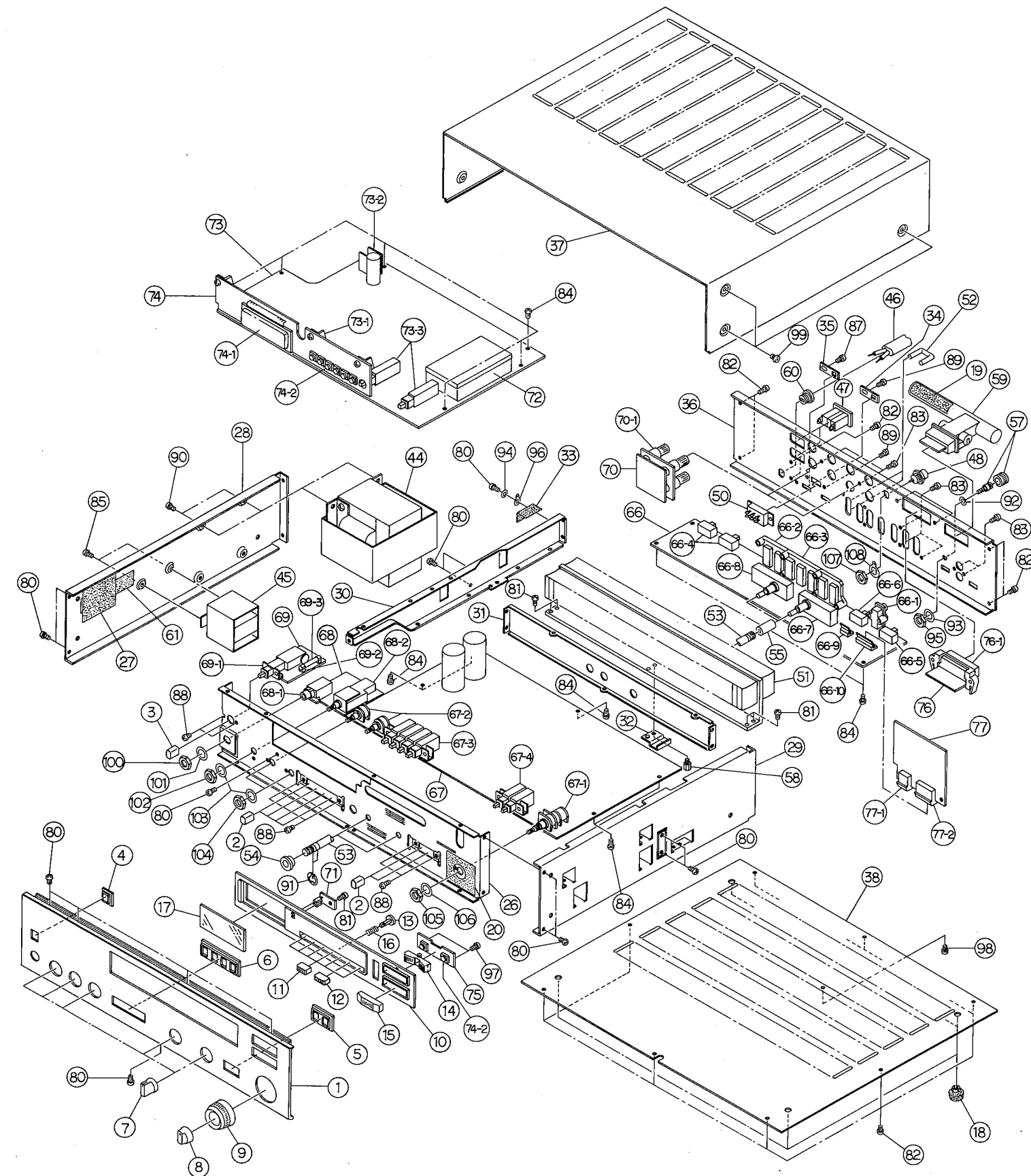

ELECTRICAL PARTS LIST

NOTE: This is not a complete electrical parts list.

FRONTEND P.C.B.: F018A (EXPLODED VIEW REF. NO. 72)

SYMBOL NO.	PARTS NO.	DESCRIPTIONS
Q1, Q2	3SK45(B)	F.E.T.
Q3	2SC461(B)	TRANSISTOR
Q4, Q5	2SC535(B)	TRANSISTOR
D1 - D5	1SV55	DIODE, VARIABLE CAPACITANCE
L1	11-431	FM ANTENNA COIL
L2	11-432	FM RF COIL
L3, L4	11-433	FM RF COIL
L5	13-533	IFT COIL
L6	12-565	OSC COIL
L7	10 μ H	CHOKER COIL
L8	0.56 μ H	CHOKER COIL
C3, C9, C11, C15, C20	36-134	TRIMMER CAPACITOR, 3 - 11pF
C21	50V, 30pF, J, RH	CERAMIC CAPACITOR
C22	50V, 15pF, J, RH	"
C23	50V, 10pF \pm 0.5pF, RH	"
C24	50V, 1pF \pm 0.25pF, CK	"
C25	50V, 1.5pF \pm 0.25pF, CK	"
C34	50V, 8pF \pm 0.5pF, CH	"

TUNER P.C.B.: I023B (EXPLODED VIEW REF. NO. 73)

SYMBOL NO.	PARTS NO.	DESCRIPTIONS
IC101	LA1222	INTEGRATED CIRCUIT
IC102	LA1235	"
IC103	LA3390	"
IC104	LB1450	"
IC105	LA1245	"
IC106, IC107, IC,122	μ PC4558	"
IC108	NJM072D	"
IC110	TC9157P	"
IC111	TD6104P	"
IC114	L78M12	"
IC115	BA656	"
Q101	2SK212(E)	F.E.T.
Q102 - Q104	2SC929(E)	TRANSISTOR
Q105, Q109, Q110	2SC1815(Y,GR)	"
Q113 - Q118, Q124	"	"
Q130	"	"
Q106 - Q108, Q111	2SA1015(Y, GR)	"
Q112, Q119, Q125	"	"
Q129	"	"
Q122, Q123	2SK30A(GR)	F.E.T.
D101 - D104, D119	1S446	DIODE
D134, D135	"	"
D105 - D114, D126	DS442BT	"
D132, D133, D136 - D139	"	"
D141, D142, D148 - D151	"	"
D159, D177	"	"

SYMBOL NO.	PARTS NO.	DESCRIPTIONS
D118	GZA6.8Y	ZENER DIODE
D127	GZA3.9Y	"
D164	GZA13X	"
D168	GZA36X	"
D170	GZA5.6Y	"
D124, D125	FC66M	VARACTOR DIODE
D165 - D167, D169	SR-1K	RECTIFIER
D171	DBA10B	"
L101	13-538	IFT COIL
L102	13-536	FM DETECTOR COIL
L103	12-564	AM OSCILLATOR COIL
L104	13-348	450KHz MATCHING COIL
L105	15-167	CHOKER COIL, 120 μ H
L106	13-347	IFT COIL
FL101	19-138	ANTIBIRDY FILTER
FL102, FL103	19-151	LOW PASS FILTER
FL104	19-152	"
FL105	19-153	"
CF101 - CF103	19-154	CERAMIC FILTER
CF104	19-136	"
CF105	19-140	"
C104	50V, 68pF, J, RH	CERAMIC CAPACITOR
C105	50V, 100pF, J, RH	"
C121	50V, 0.68 μ F	ELECTROLYTIC CAPACITOR, LOW LEAKAGE
C124	50V, 3.3 μ F	"
C125, C160, C214	50V, 2.2 μ F	"
C126, C169, C215	50V, 1 μ F	"
C147, C148, C209	36-136	TRIMMER CAPACITOR, 5.2 - 30pF
C163, C204	50V, 0.22 μ F	ELECTROLYTIC CAPACITOR, LOW LEAKAGE
C201, C243	50V, 0.1 μ F	"
C202	50V, 0.33 μ F	"
C213	5.5V, 0.047 μ F	MEMORY BACKUP CAPACITOR
C245	50V, 68pF, J, COG] 50V, 15pF, J, RH]	CERAMIC CAPACITOR
R107, R167	20K Ω , B	VARIABLE RESISTOR
R158, R208	50K Ω , B	"
R164, R249, R250	10K Ω , B	"
R185	6.8K Ω , 1/2W	CARBON RESISTOR
R256	5K Ω , B	VARIABLE RESISTOR
R311	240 Ω , 1W	OXIDE METAL RESISTOR, RSF1B
R322	220K Ω x 5	RESISTOR ARRAY
XTAL201	19-205	CRYSTAL, 7.2MHz
S103, S104	81-451	DEEMPHASIS, SLIDE SWITCH
S105	"	9/10KHz, "
FU201	MDL1/10 100mA	FUSE, 250V, 1/10A (A VERSION)
FU202	MDL3/8 315mA	FUSE, 250V, 100mA (B, C VERSION) FUSE, 250V, 3/8A (A VERSION) FUSE, 250V, 315mA (B, C VERSION)

DISPLAY & PRESET SELECTOR P.C.B.: D012A (EXPLODED VIEW REF. NO. 74)

SYMBOL NO.	PARTS NO.	DESCRIPTIONS
IC113	TD6301AP	INTEGRATED CIRCUIT
Q126 - 128	2SC1815	TRANSISTOR
D157, D158	DS442	DIODE
R229 R300	33KΩ x 13 33KΩ x 10	RESISTOR ARRAY "
FLU101	7AM8AS	FL INDICATOR

ANTENNA TERMINAL P.C.B.: Z002A (EXPLODED VIEW REF. NO. 76)

SYMBOL NO.	PARTS NO.	DESCRIPTIONS
L107	11-419	BALUN TRANSFORMER

INPUT/OUTPUT P.C.B.: J013A (EXPLODED VIEW REF. NO. 66)

SYMBOL NO.	PARTS NO.	DESCRIPTIONS
Q509, Q559	2SC3329	TRANSISTOR
Q510, Q560	2SA1015	"
Q511, Q561, Q512	2SC2362	"
Q562	2SC2362	"
Q541	2SC3114	"
D851 - D854	DS442BT	DIODE
D855, D856	GZA18Y	ZENER DIODE
R519, R569	1.5KΩ, GorF, 1/4W	OXIDE METAL RESISTOR
R520, R570	120Ω, GorF, 1/4W	"
R521, R571	22Ω, GorF, 1/4W	"
R522, R525, R572, R575	470Ω, GorF, 1/4W	"
R526, R576	3.9KΩ, GorF, 1/4W	"

PHONO AMP P.C.B.: E014A (EXPLODED VIEW REF. NO. 77)

SYMBOL NO.	PARTS NO.	DESCRIPTIONS
Q501, Q551	2SA1016	TRANSISTOR
Q502, Q552	2SK163	F.E.T.
Q503, Q553	2SK163	F.E.T.
Q504, Q554	2SC2362	TRANSISTOR
Q505, Q555	2SC3114	"
Q506, Q556, Q507	2SA1246	"
Q557, Q508, Q558	2SA1246	"
D501, D502, D503	DS442	DIODE
D504, D505, D551	"	"
D552, D553, D554	"	"
D555	"	"

SYMBOL NO.	PARTS NO.	DESCRIPTIONS
L500, L550	15-168	CHOKE COIL, 3.7μH
C502, C552	25V, 2.2μF	ELECTROLYTIC CAPACITOR, LOW LEAKAGE
R507, R557 R508, R558	7.5KΩ, F, 1/4W 95.3KΩ, F, 1/4W	METAL FILM RESISTOR, SN14K2E " "

MAIN/CONTROL AMP & POWER SUPPLY P.C.B.: J011B (EXPLODED VIEW REF. NO. 67)

SYMBOL NO.	PARTS NO.	DESCRIPTIONS
IC601	NJM2043D	INTEGRATED CIRCUIT
IC801	TA7317P	"
IC901	M5231L	"
IC902	L78M24	"
Q601, Q651	2SC2362	TRANSISTOR
Q701, Q751	2SC2362	"
Q602, Q652	2SA992	"
Q603, Q653	2SK363	F.E.T.
Q604	2SC3114	TRANSISTOR
Q605, Q702, Q752	2SA1246	"
Q903, Q905	2SA1246	"
Q606	2SA733A	"
Q607	2SC945A	"
Q703, Q753	2SA970	"
Q704, Q706, Q754	2SC2690	"
Q756	2SC2690	"
Q707, Q757	2SA1220	"
Q712, Q762	2SC1841	"
Q801	2SA988	"
Q901	2SD414	"
Q902, Q904	2SB548	"
D601, D651, D701	DS442BT	DIODE
D702, D703, D704	"	"
D751, D752, D753	"	"
D754, D801	"	"
D901-D904, D909	DS135E	"
D905-D908	GSA30C	"
D910	BZ350	"
L701, L751	15-147	COIL
C603, C608, C653	50V, 1μF, HL	ELECTROLYTIC CAPACITOR, LOW LEAKAGE
C658, C701, C702	"	"
C751, C752	"	"
C617, C667	50V, 0.68μF, HL	"
C928, C929	50V, 10000μF	"
R708, R758	41-783, RVF8P	VARIABLE RESISTOR, 500Ω
R712, R762	330Ω, J, 1/4W	FUSIBLE RESISTOR
R715, R765, R736	820Ω, J, 2W	POWER RESISTOR
R716, R766	1.5KΩ, J, 2W	"
R717, R767	1.2KΩ, J, 2W	"
R718, R768	100Ω, J, 1/4W	FUSIBLE RESISTOR
R721, R771	41-781, RVF8P	VARIABLE RESISTOR, 200Ω
R728, R729, R730	0.33Ω, K, 5W	CEMENTED WIREWOUND RESISTOR
R731, R778, R779	"	"
R780, R781	"	"

SYMBOL NO.	PARTS NO.	DESCRIPTIONS
R732, R782	10Ω, J, 1W	POWER RESISTOR
R735, R785	2.2Ω, J, 1W	"
R801	33Ω, J, 1/4W	FUSIBLE RESISTOR
R807	680Ω, J, 2W	OXIDE METAL RESISTOR, RSF-2B
R901, R902	3.3Ω, J, 1W	" , RSF1B
R905, R906	10Ω, J, 1/4W	FUSIBLE RESISTOR
R907	220Ω, J, 5W	POWER RESISTOR
R908	470Ω, J, 5W	"
R909	470Ω, J, 1/4W	FUSIBLE RESISTOR
R926	6.8KΩ, J, 1W	POWER RESISTOR
RY801	81-619	RELAY
Q705, Q755	2SD414	TRANSISTOR
Q708, Q709, Q758	2SD1148	POWER TRANSISTOR
Q759	2SD1148	"
Q710, Q711, Q760	2SB863	"
Q761	2SB863	"
S801	81-7002	THERMOSTAT

SPEAKER SWITCH P.C.B.: S078A (EXPLODED VIEW REF. NO. 68)

SYMBOL NO.	PARTS NO.	DESCRIPTIONS
R951, R952	470Ω, 1W	OXIDE METAL RESISTOR, RSF1B

POWER SWITCH P.C.B.: S079B (EXPLODED VIEW REF. NO. 69)

SYMBOL NO.	PARTS NO.	DESCRIPTIONS
C952	DE7100FZ	CERAMIC CAPACITOR
FU951	MDX-4/MSL-4	FUSE, 125V, 4A (A VERSION)
	MDX-3.2/10	FUSE, 125V, 3.2/10A (A1 VERSION)
	T, 2A	FUSE, 250V, 2A (B, C VERSION)

LED DISPLAY P.C.B.: M106B (EXPLODED VIEW REF. NO. 71)

SYMBOL NO.	PARTS NO.	DESCRIPTIONS
D951	SY440D	L.E.D., FM STEREO
D952	SG240D	L.E.D., SOFT CLIP

SERVICE MANUAL

7155
AM/FM STEREO RECEIVER

NAD ELECTRONICS
BOSTON LONDON TOKYO