

December 2005



SERVICE MANUAL

C 300

**STEREO
AMPLIFIER**

C 300

**STEREO
AMPLIFIER**

TABLE OF CONTENTS

DESCRIPTION	PAGE
REAR PANEL/FRONT PANEL VIEW.....	3
SPECIFICATIONS.....	4-5
DISASSEMBLY INSTRUCTIONS.....	6
ALIGNMENT PROCEDURE.....	7
PCB LAYOUT.....	8-9
SCHEMATIC DIAGRAM.....	10
WIRING DIAGRAM.....	11
IC BLOCK DIAGRAM.....	12
ELECTRICAL PARTS LIST.....	13-16
EXPLODED VIEW PARTS LIST.....	17
EXPLODED VIEW.....	18
PACKING DIAGRAM.....	19

SERVICE SAFETY PRECAUTIONS

1. Replacing the fuses

CAUTION: FOR CONTINUED PROTECTION AGAINST THE RISK OF FIRE, REPLACE ONLY WITH DESIGNATED TYPE OF FUSE FOR *AH, *B1, *B AND *C VERSIONS.

Reference No	Part Number	Description
F701—F702	20-00500-25	T5AL250V Fuse
F703—F704	20-00050-25	T0.5AL250V Fuse

NOTE:

- <*AH> : USA, CANADIAN MODEL ONLY.
- <*B> : UK MODEL ONLY.
- <*B1> : AUSTRALIAN MODEL ONLY.
- <*C> : EUROPEAN MODEL ONLY.

2. Safety check out

(Only U.S.A. Model)

Before returning the product to the customer, make leakage current or resistance measurements to determine that exposed parts are acceptably insulated from the supply circuit.

Parts marked with the symbol “” are critical with regard to the risk of fire and electric shock. Replace only with parts recommended by the manufacturer.

REAR PANEL/FRONT PANEL VIEW

REAR PANEL

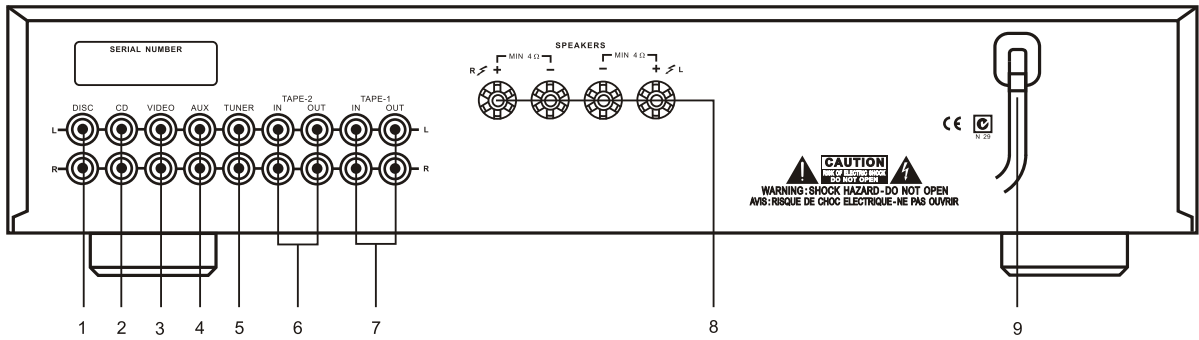

- 1. Disc Input
- 2. CD Input
- 3. Video Input
- 4. Aux Input
- 5. Tuner Input
- 6. Tape 2 In, Out
- 7. Tape 1 In, Out
- 8. Speakers
- 9. AC Line Cord

FRONT PANEL

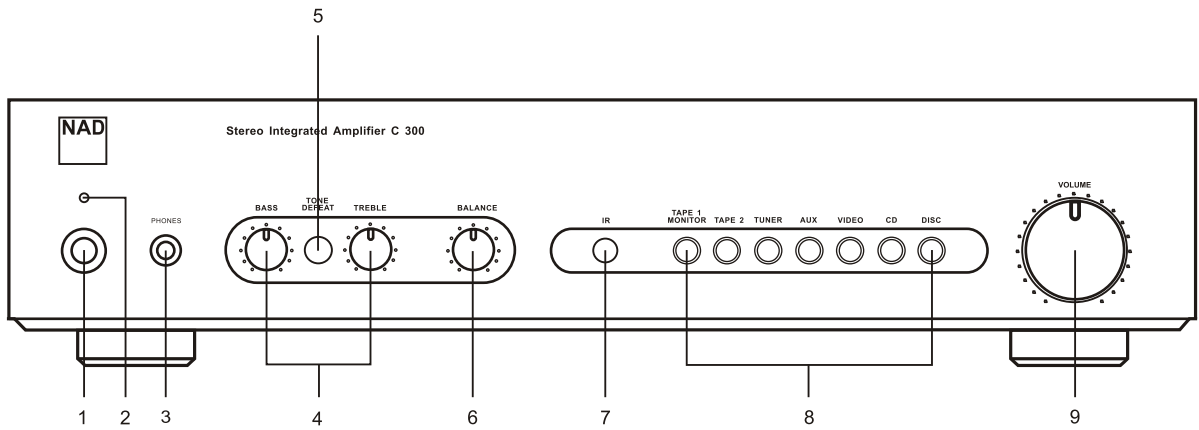

- 1. Power
- 2. Power/Protection/Mute LED
- 3. Headphone Socket
- 4. Bass & Treble Controls
- 5. Tone Defeat
- 6. Balance
- 7. Infra-red Receiver
- 8. Input Selectors(Disc, CD, Video, Aux, Tuner, Tape 2, Tape1 Monitor)
- 9. Volume

REMOTE CONTROL

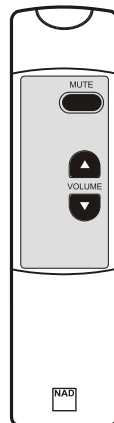

SPECIFICATIONS

POWER AMPLIFIER SECTION

STEREO MODE

CONTINUOUS AVERAGE POWER OUTPUT INTO 8 OHMS.....	25W
(Min. Power per channel, 20Hz-20kHz, both channels driven, with no more than rated distortion)	
Rated impedance.....	4-8ohms
Rated distortion (THD 20Hz-20kHz).....	0.03%
Clipping power (maximum continuous power per channel)	30W
IHF dynamic headroom at 8 ohms.....	+2.4dB
IHF dynamic power	
8 ohms:	43W
4 ohms:	65W
2 ohms:	90W
Damping factor (ref. 8 ohms 50Hz)	>100
Peak undistorted O/P current (into 0.1—0.5ohms, both channels running) ...	40A
Frequency response at 20Hz-20kHz (Tone Control in).....	0±0.5dB
Frequency response at 10Hz/70kHz.....	-2dB
THD.....	<0.03%
(Total Harmonic Distortion, 20Hz-20kHz, from 250mW to rated output)	
SMPTE I.M.	<0.03%
(IM distortion, 60Hz + 7kHz, 4:1, from 250mW to rated output)	
IHF I.M. (CCIF IM distortion, 19+20kHz at rated output) and DIM 100.....	<0.03%

PREAMPLIFIER SECTION

Line Level Inputs (Disc, CD, Video, Aux, Tuner, Tape 1, Tape 2)	
Input impedance (R and C)	210kohms//320pF
Input sensitivity (ref. rated power)	200mV
Maximum input level.....	5V rms
Signal /Noise ratio, A-weighted.....	>100dB ref.1W >114dB ref. rated power
Maximum Output Level (Tape 1&2).....	5V rms

TONE CONTROLS

Treble (at 10kHz).....	±6dB
Bass (at 100Hz)	±5dB

PHYSICAL SPECIFICATION

Dimensions in mm (Width × Height × Depth)	435 × 95 × 325
Net weight.....	5.0kg
Shipping Weight.....	6.2kg
Power Consumption(at 2 × 50W/4ohms output) 230V 50Hz.....	185W

ALIGNMENT PROCEDURE

A. OUTPUT OFFSET VOLTAGE

1. Push Power on, preheat unit for 5 minutes.
2. Connect the DC Millivoltmeter to L Channel speaker output terminals or TP5 and TP7, adjust VR301 to get a reading of $0V \pm 30mV$.
3. Connect the DC Millivoltmeter to R Channel speaker output terminals or TP6 and TP8, adjust VR401 to get a reading of $0V \pm 30mV$.

B. IDLING CURRENT

1. Connect the DC Millivoltmeter across D305, adjust VR302 for 160 -- 180mV reading on meter.
2. Connect the DC Millivoltmeter across D405, adjust VR402 for 160 -- 180mV reading on meter.

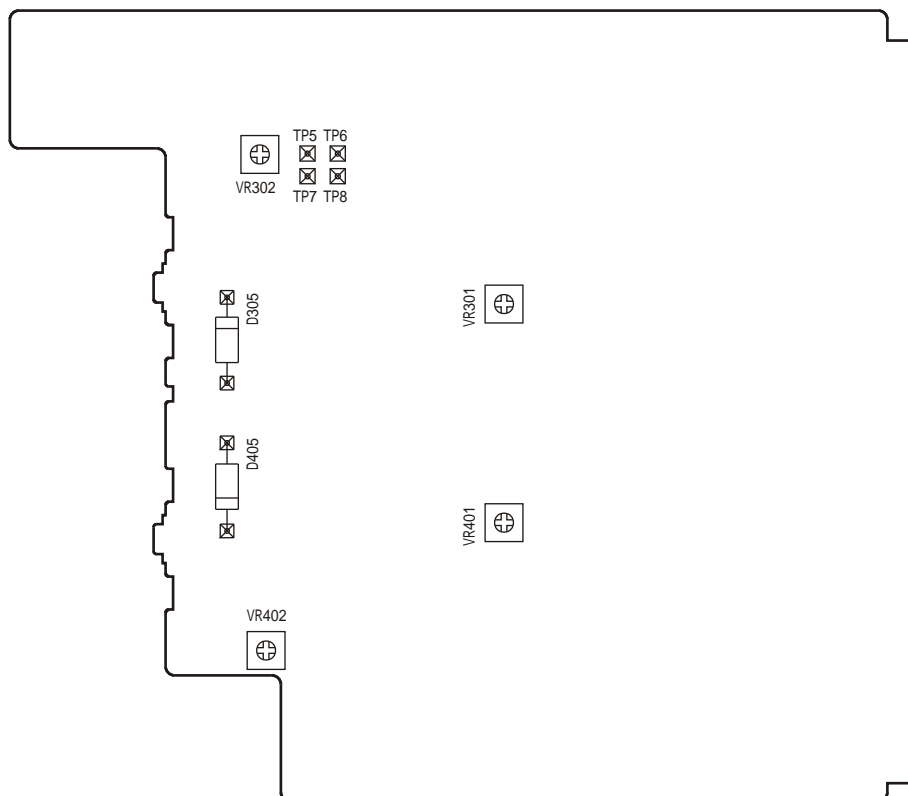

PCB LAYOUT

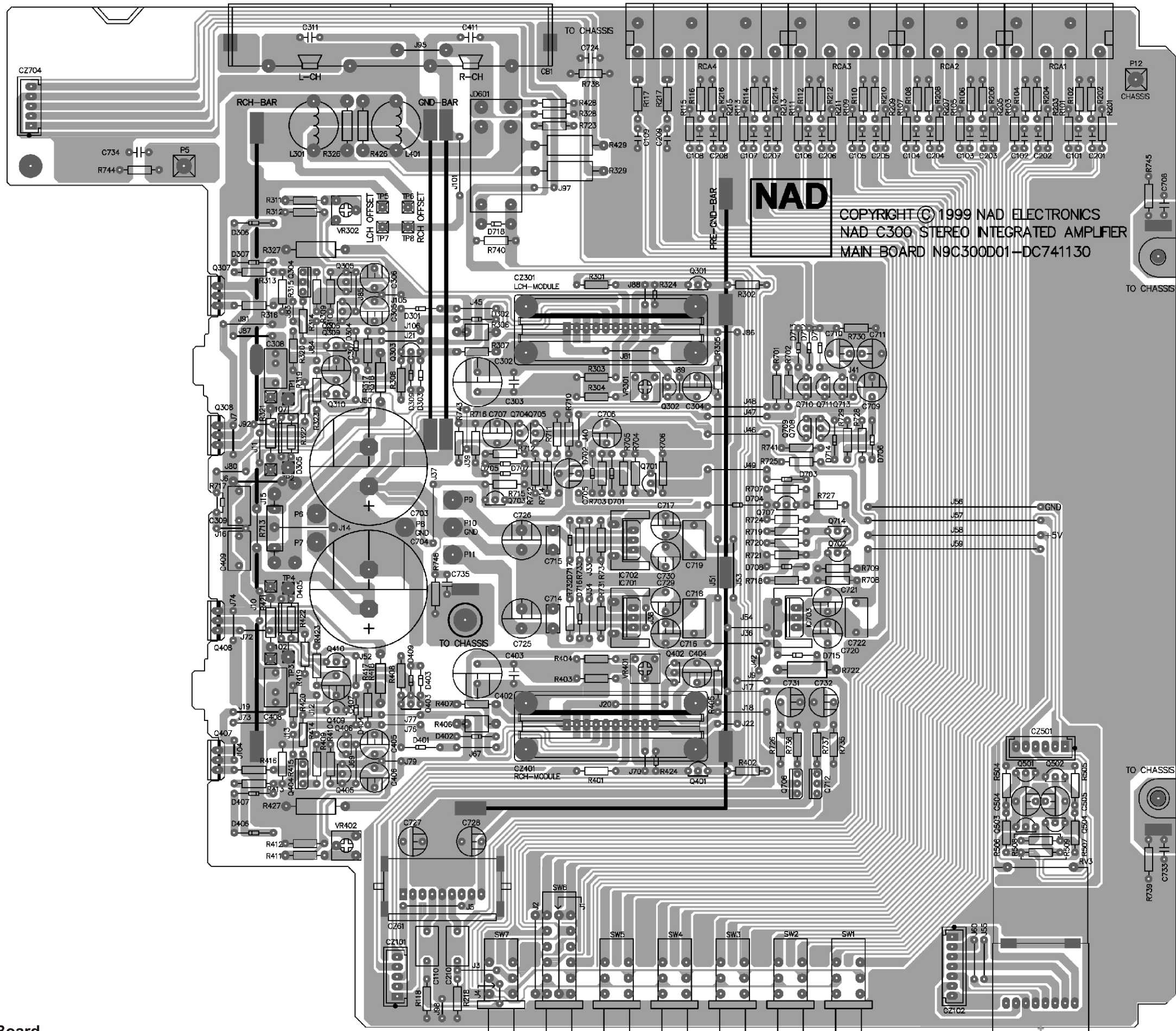



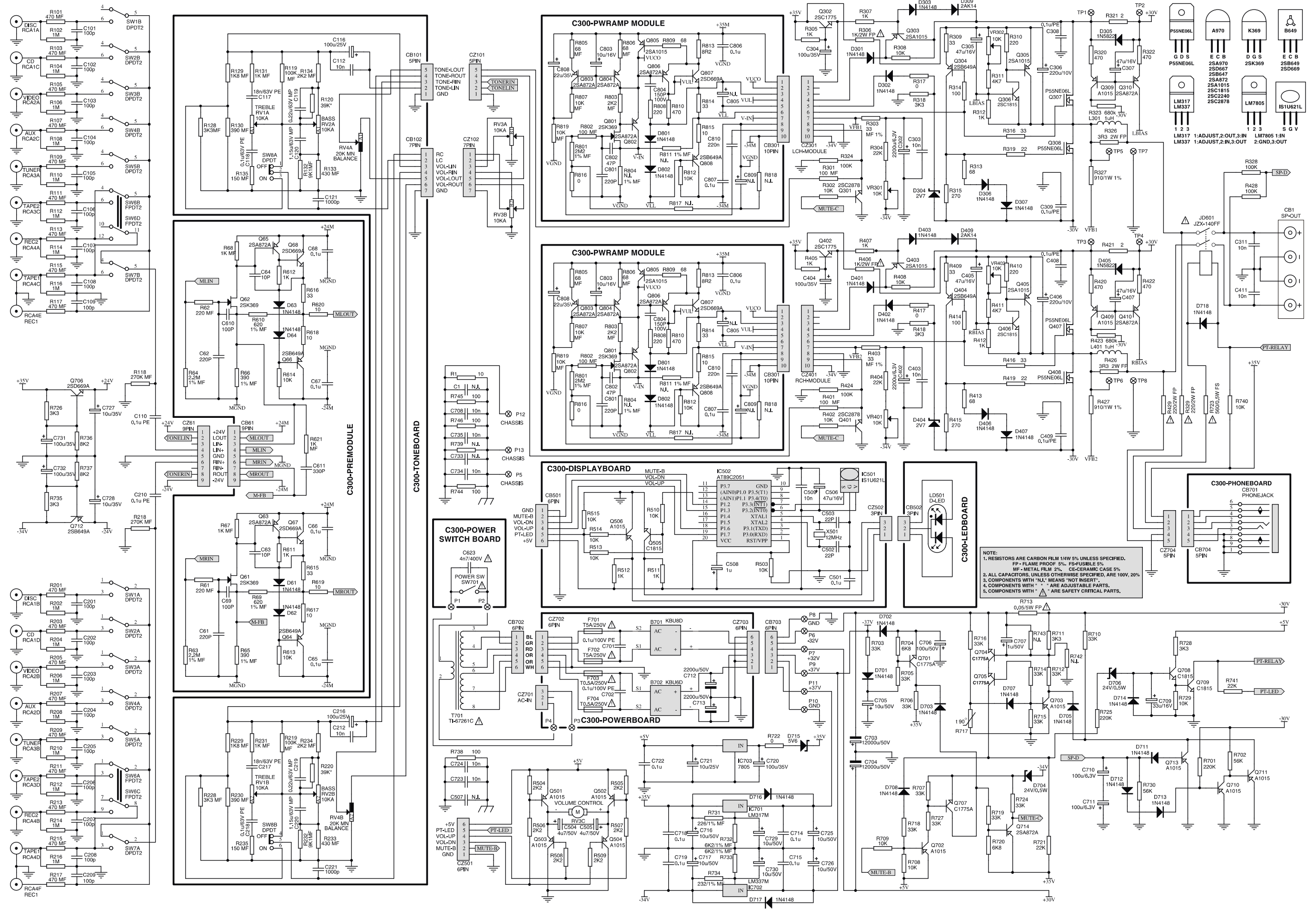

Main Board

SCHEMATIC DIAGRAM



ELECTRICAL PARTS LIST

REF. NO.	PART NO.	DESCRIPTION				
RESISTORS						
R717	07-90001-00T	t= 90°			Posistor	
R813x2	07-05082-06	8R2	1/6W	5%	Carbon Film Resistor	
R1, R617, R618, R619, R620, R815x2	07-05100-06	10	1/6W	5%	Carbon Film Resistor	
R615, R616, R814x2	07-05330-06	33	1/6W	5%	Carbon Film Resistor	
R809x2	07-05680-06	68	1/6W	5%	Carbon Film Resistor	
R808x2	07-05221-06	220	1/6W	5%	Carbon Film Resistor	
R810x2	07-05471-06	470	1/6W	5%	Carbon Film Resistor	
R611, R612	07-05102-06	1K	1/6W	5%	Carbon Film Resistor	
R613, R614, R812x2	07-05103-06	10K	1/6W	5%	Carbon Film Resistor	
R324, R424	07-05104-06	100K	1/6W	5%	Carbon Film Resistor	
R321, R421	07-05020-04	2	0.25W	5%	Carbon Film Resistor	
R319, R419	07-05220-04	22	0.25W	5%	Carbon Film Resistor	
R309, R316, R409, R416	07-05330-04	33	0.25W	5%	Carbon Film Resistor	
R313, R413	07-05680-04	68	0.25W	5%	Carbon Film Resistor	
R314, R414, R738, R744, R745	07-05101-04	100	0.25W	5%	Carbon Film Resistor	
R310, R410	07-05221-04	220	0.25W	5%	Carbon Film Resistor	
R315, R415	07-05271-04	270	0.25W	5%	Carbon Film Resistor	
R305, R307, R312, R405, R407, R412, R511, R512	07-05102-04	1K	0.25W	5%	Carbon Film Resistor	
R320, R322, R420, R422	07-05471-04	470	0.25W	5%	Carbon Film Resistor	
R504, R505, R506, R507, R508, R509	07-05222-04	2K2	0.25W	5%	Carbon Film Resistor	
R711, R726, R728, R735	07-05332-04	3K3	0.25W	5%	Carbon Film Resistor	
R318, R418						
R311, R411	07-05472-04	4K7	0.25W	5%	Carbon Film Resistor	
R704, R720	07-05682-04	6K8	0.25W	5%	Carbon Film Resistor	
R736, R737	07-05822-04	8K2	0.25W	5%	Carbon Film Resistor	
R302, R308, R402, R408, R503, R510, R513, R514, R515, R708, R709, R729, R740	07-05103-04	10K	0.25W	5%	Carbon Film Resistor	
R304, R404, R721, R741	07-05223-04	22K	0.25W	5%	Carbon Film Resistor	
R703, R705, R706, R707, R710, R712, R714, R715, R716, R718, R719, R724, R727	07-05333-04	33K	0.25W	5%	Carbon Film Resistor	
R702, R730	07-05563-04	56K	0.25W	5%	Carbon Film Resistor	
R328, R428	07-05104-04	100K	0.25W	5%	Carbon Film Resistor	
R701, R725	07-05224-04	220K	0.25W	5%	Carbon Film Resistor	
R323, R423	07-05684-04	680K	0.25W	5%	Carbon Film Resistor	
R102, R104, R106, R108, R110, R112, R114, R116, R202, R204, R206, R208, R210, R212, R214, R216	07-05105-04	1M	0.25W	5%	Carbon Film Resistor	
R713	07-05005-50A	0.05	5W	5%	Cerment Resistor	
 R327, R427	07-01911-10B	910	1W	1%	Flame Proof Resistor	
 R326, R426	07-05033-20B	3R3	2W	5%	Flame Proof Resistor	
 R329, R429	07-05221-20B	220	2W	5%	Flame Proof Resistor	
 R306, R406	07-05102-20B	1K	2W	5%	Flame Proof Resistor	
 R723	07-10561-02C	560	0.5W	10%	Fusible Resistor	
R805x2, R806x2	07-05680-06D	68	1/6W	5%	Metal Film Resistor	
R802x2	07-05101-06D	100	1/6W	5%	Metal Film Resistor	
R61, R62	07-05221-06D	220	1/6W	5%	Metal Film Resistor	
R65, R66	07-01391-06D	390	1/6W	1%	Metal Film Resistor	
R69, R610	07-01621-06D	620	1/6W	1%	Metal Film Resistor	
R67, R68	07-05102-06D	1K	1/6W	5%	Metal Film Resistor	







ELECTRICAL PARTS LIST CONTINUATION

REF. NO.	PART NO.	DESCRIPTION			
R621	07-05102-06D	1K	1/6W	5%	Metal Film Resistor
R803x2	07-05222-06D	2K2	1/6W	5%	Metal Film Resistor
R807x2, R819x2	07-05103-06D	10K	1/6W	5%	Metal Film Resistor
R120, R220	07-05393-06D	39K	1/6W	5%	Metal Film Resistor
R63, R64	07-01225-06D	2M2	1/6W	1%	Metal Film Resistor
R801x2	07-01225-06D	2M2	1/6W	1%	Metal Film Resistor
R303, R403	07-01330-04D	33	0.25W	1%	Metal Film Resistor
R301, R401	07-05101-04D	100	0.25W	5%	Metal Film Resistor
R135, R235	07-05151-04D	150	0.25W	5%	Metal Film Resistor
R731	07-012260-04D	226	0.25W	1%	Metal Film Resistor
R734	07-012320-04D	232	0.25W	1%	Metal Film Resistor
R130, R230	07-05391-04D	390	0.25W	5%	Metal Film Resistor
R133, R233	07-05431-04D	430	0.25W	5%	Metal Film Resistor
R105, R107, R115, R207, R209, R101, R201, R117, R211, R103, R215, R111, R109, R205, R217, R203, R113, R213	07-05471-04D	470	0.25W	5%	Metal Film Resistor
R131, R231	07-05102-04D	1K	0.25W	5%	Metal Film Resistor
R129, R229	07-05182-04D	1K8	0.25W	5%	Metal Film Resistor
R134, R234	07-05222-04D	2K2	0.25W	5%	Metal Film Resistor
R128, R228	07-05332-04D	3K3	0.25W	5%	Metal Film Resistor
R732, R733	07-01622-04D	6K2	0.25W	1%	Metal Film Resistor
R132, R232	07-05912-04D	9K1	0.25W	5%	Metal Film Resistor
R119, R219	07-05104-04D	100K	0.25W	5%	Metal Film Resistor
R118, R218	07-05274-04D	270K	0.25W	5%	Metal Film Resistor
POTENTIOMETERS					
RV1, RV2	09-16103-12	10KA			TONE Potentiometers
RV3	09-16103-12M	10KA			VOLUME Potentiometer
RV4	09-16203-02	20K MN			BALANCE Potentiometer
VR301, VR302, VR401, VR402	10-01103-00T	10K			SEMI Potentiometers
CAPACITORS					
C63, C64	05-00100-20	10pF	50V	±20%	Ceramic Disk Capacitor
C502, C503	05-00220-20	22pF	50V	±20%	Ceramic Disk Capacitor
C802x2	05-00470-10	47pF	50V	±10%	Ceramic Disk Capacitor
C101, C102, C103, C104, C105, C106, C107, C108, C109, C201, C202, C203, C204, C205, C206, C207, C208, C209	05-00101-20	100pF	50V	±10%	Ceramic Disk Capacitor
C69, C610	05-00101-20	100pF	50V	±10%	Ceramic Disk Capacitor
C804x2	05-00151-10	150pF	100V	±10%	Ceramic Disk Capacitor
C61, C62, C801x2	05-00221-10	220pF	50V	±10%	Ceramic Disk Capacitor
C611	05-00331-10	330pF	50V	±10%	Ceramic Disk Capacitor
C121, C221	05-00102-20	1000pF	50V	±10%	Ceramic Disk Capacitor
⚠ C623	05-04472-20	4.7nF	400V	±20%	Ceramic Disk Capacitor
C112, C212, C509, C708, C723, C724, C734	05-00103-20	10nF	50V	+50-20%	Ceramic Disk Capacitor
C65, C66, C67, C68, C501, C714, C715, C718, C719, C722, C806x2, C807x2,	05-10104-20	0.1uF	50V	±20%	Ceramic Disk Capacitor
C311, C411, C303, C403	05-30103-10	10nF	63V	±10%	Polyester Film Capacitor
C117, C217	05-30183-10	18nF	63V	±10%	Polyester Film Capacitor
C110, C210, C118, C218, C308, C309, C408, C409	05-30104-10	0.1uF	63V	±10%	Polyester Film Capacitor
C701, C702	05-31104-10	0.1uF	100V	±10%	Polyester Film Capacitor
C120, C220	05-20115-10A	1.15uF	63V	±5%	Metallized Polyester Film Capacitor
C119, C219, C810x2	05-20224-10A	0.22uF	63V	±5%	Metallized Polyester Film Capacitor

ELECTRICAL PARTS LIST CONTINUATION

REF. NO.	PART NO.	DESCRIPTION			
C508, C707	06-50105-20	1uF	50V	±20%	Electrolytic Capacitor
C504, C505	06-50475-20	4.7uF	50V	±20%	Electrolytic Capacitor
C803x2	06-16106-20M	10uF	16V	±20%	Electrolytic Capacitor
C721	06-25106-20	10uF	25V	±20%	Electrolytic Capacitor
C727, C728	06-35106-20	10uF	35V	±20%	Electrolytic Capacitor
C705, C716, C717, C725, C726, C729, C730	06-50106-20	10uF	50V	±20%	Electrolytic Capacitor
C808x2	06-35226-20M	22uF	35V	±20%	Electrolytic Capacitor
C709	06-16336-20	33uF	16V	±20%	Electrolytic Capacitor
C305, C307, C405, C407, C506	06-16476-20	47uF	16V	±20%	Electrolytic Capacitor
C116, C216	06-25107-20	100uF	25V	±20%	Electrolytic Capacitor
C710, C711	06-06107-20	100uF	6.3V	±20%	Electrolytic Capacitor
C304, C404, C720, C731, C732	06-35107-20	100uF	35V	±20%	Electrolytic Capacitor
C706	06-50107-20	100uF	50V	±20%	Electrolytic Capacitor
C306, C406	06-10227-20	220uF	10V	±20%	Electrolytic Capacitor
C703, C704	06-50109-20	10000uF	50V	+50%-20%	Electrolytic Capacitor
C302, C402	06-06228-20	2200uF	6.3V	±20%	Electrolytic Capacitor
C712, C713	06-50228-20	2200uF	50V	±20%	Electrolytic Capacitor
DIODES					
D304, D404	02-00027-05	2V7	0.5W		Zener Diode
D715	02-00056-05	5V6	0.5W		Zener Diode
D704, D706	02-00240-05	24V	0.5W		Zener Diode
D801x2, D802x2, D61, D63	02-24148-00	1N4148			Switch Diode
D303, D403, D718	02-24148-00	1N4148			Switch Diode
D62, D64, D302, D306, D307, D301, D401, D402, D406, D407, D701, D702, D703, D705, D707, D708, D711, D712, D713, D714, D716, D717	02-24148-00	1N4148			Switch Diode
D305, D405	02-15822-00	1N5822			Schottky Diode
D309, D409	02-00014-00	2AK14			Switch Diode
LD501	02-30515-255	D-LED	5		Dual-Color LED
B702	02-42006-00	KBU6D			Rectifier Bridge
B701	02-42008-00	KBU8D			Rectifier Bridge
IC					
IC501	03-10621-03	IS1U621L			IR Sensor
IC502	03-02051-20	AT89C2051-24			Micom
IC701	03-00317-03	LM317T			Regulator
IC702	03-00337-03	LM337T			Regulator
IC703	03-07805-03	7805			Regulator
TRANSISTORS					
Q303, Q305, Q309, Q403, Q405, Q409, Q501, Q502, Q503, Q504, Q506, Q702, Q703, Q710, Q711, Q713, Q805x2	01-01015-070	2SA1015-GR			Small Signal Transistor
Q63, Q65, Q310, Q410, Q714, Q802x2, Q803x2, Q804x2, Q806x2	01-00872-020	2SA872AE			Small Signal Transistor
Q64, Q66, Q304, Q404, Q712, Q808x2	01-00649-001	2SB649A			Power Transistor

ELECTRICAL PARTS LIST CONTINUATION

REF. NO.	PART NO.	DESCRIPTION
Q302, Q402, Q701, Q704, Q705, Q707	01-01775-000	2SC1775AE Small Signal Transistor
Q306, Q406, Q505, Q708, Q709	01-01815-070	2SC1815-GR Small Signal Transistor
Q301, Q401	01-02878-020	2SC2878-A Switching Transistor
Q67, Q68, Q706, Q807×2	01-00669-001	2SD669A Power Transistor
Q307, Q308, Q407, Q408	01-00055-003	STP55NE06L Power MOSFET
Q61, Q62, Q801×2	01-00369-070	2SK369-GR Junction FET
SWITCHES		
SW1, SW2, SW3, SW4, SW5, SW6, SW7	11-03007-00	SW1-SW5, SW7 DPDT2 SW6 FPDT2 Latching Switch
SW8	11-01022-01	DPDT2 Push Switch
 SW701	11-01001-00	SDDL1027U-RN Power Switch
FUSES		
 F703, F704	20-00050-25	T500mA 250V Time-lag Fuse
 F701, F702	20-00500-25	T5A 250V Time-lag Fuse
OTHERS		
L301, L401	08-15580-10	1uH Air Inductor
 T701*C	08-67261-00	TI-67261D Transformer C Version
 T701*AH	08-67262-00	TI-67262 Transformer AH Version
 JD601	12-02024-05	FTR-F1AA024A Relay
TP5, TP6, TP7, TP8	13-01000-00	Test Pin
CB701	17-00200-01	PHONE JACK Head Phone Jack
RCA1, RCA2, RCA3	17-01200-04	4-Pin RCA
RCA4	17-01200-06	6-Pin RCA
CB1	17-02200-04	Binding Post

EXPLODED VIEW PARTS LIST

REF. NO.	PART NO.	DESCRIPTION	Qty.	REF. NO.	PART NO.	DESCRIPTION	Qty.
C001	45-00300-01	Chassis	1		17-01200-06	6-Pin RCA	1
C002	45-00300-04	Base Cover	1	C037	45-00320-08	Module Support 1	1
C003	53-00320-05	Foot	4				
C004	56-00320-01	Foot Pad	4	F001	55-00300-01	Fascia	1
C005	09-16103-12M	Volume Potentiometer	1	F002	53-00300-01	Input Button Lozenge	1
C006	11-03007-00	Latching Switch	1	F003	53-00320-01	Tone Control Lozenge	1
C007	45-00300-02	Stopper	2	F004	51-00320-01	Volume Knob	1
C008	40-08040-22	Bolt	1	F005	51-00320-02	Tone Knob	3
C009	45-00320-07	Trans. Bracket	1	F006	52-00320-02	Power Button	1
C010	46-00320-03	Shielding Box	1	F007	53-00300-02	Push Button	8
C011	43-08002-00	Spring Washer	2	F008	53-00320-04	Power Button Bezel	1
C012	41-08008-00	Nut	2	F009	54-00320-02	LED Lens	1
C013	56-00320-05	Rubber Pad	2	F010	54-00320-01	IRS LENS	1
⚠ C014*C	08-67261-00	Transformer C Version	1	S001	45-00300-03	Subfascia	1
⚠ C014*AH	08-67262-00	Transformer AH Version	1	S002	45-00300-10	IR Cover	1
C015	45-00320-09	Transformer Disc	1	S003	45-00300-09	Bracket (PH.)	1
C016	69-00320-02	Transformer Label	1	⚠ S004	11-01001-00	Power Switch	1
C017	47-00300-03	Heat Sink(Big) Plate	1	S005	17-00200-01	Head Phone Jack	1
C018	47-00300-02	Heat Sink	1	S006	11-01022-01	Push Switch	1
C019	56-00300-01	Heat Conductive Pad	4	S007	09-16203-02	BALANCE POT	1
C020	16-0C300-11	Power Transistor Fixer	2	S008	09-16103-12	TONE POT	2
C021	45-00300-06	Tr. Clamper	2				
C022	07-90001-00T	Posistor	1	R001*C	46-00300-02	Rear Panel	1
C023	45-00300-05	PCB Support	1	R001*AH	46-00300-02H	Rear Panel	1
C024	55-00300-02	Module Lid	2	⚠ R002	58-00320-01	Strain Relief Bushing	1
C025	45-00300-13	Trans.Clamp (Module)	2	⚠ R003*C	15-00183-00	AC Cord C Version	1
C026	47-00300-04	Module Support 2	2	⚠ R003*AH	15-00183-00H	AC Cord AH Version	1
C027	56-00300-02	Insulated Cushion	2				
C028	47-00300-01	Small Heatsink	3	T001	46-00300-01	Top Cover	1
C029	48-00300-04	Bus Bar (3)	1				
C030	48-00300-02	Bus Bar (1)	2	0001	40-04008-07	Self Taping Screw(4x8)	8
C031	48-00300-03	Bus Bar (2)	1	0002	40-04012-01	Machine Screw(4x12)	2
C032	59-00300-02	PCB Spacer	1	0003	40-03008-01	Self Taping Screw(STB3x8)	5
C033	45-00300-11	BDP Support	1	0004	40-13008-01	Self Taping Screw(BTB3x8)	17
C034	48-00300-01	Pin (BDP)	1	0005	40-03006-01	Self Taping Screw(3x6)	46
C035	17-02200-04	Speaker Binding Post	1	0006	40-12604-01	Self Taping Screw(2.6x4)	2
C036	17-01200-04	4-Pin RCA	3				

EXPLODED VIEW DIAGRAM

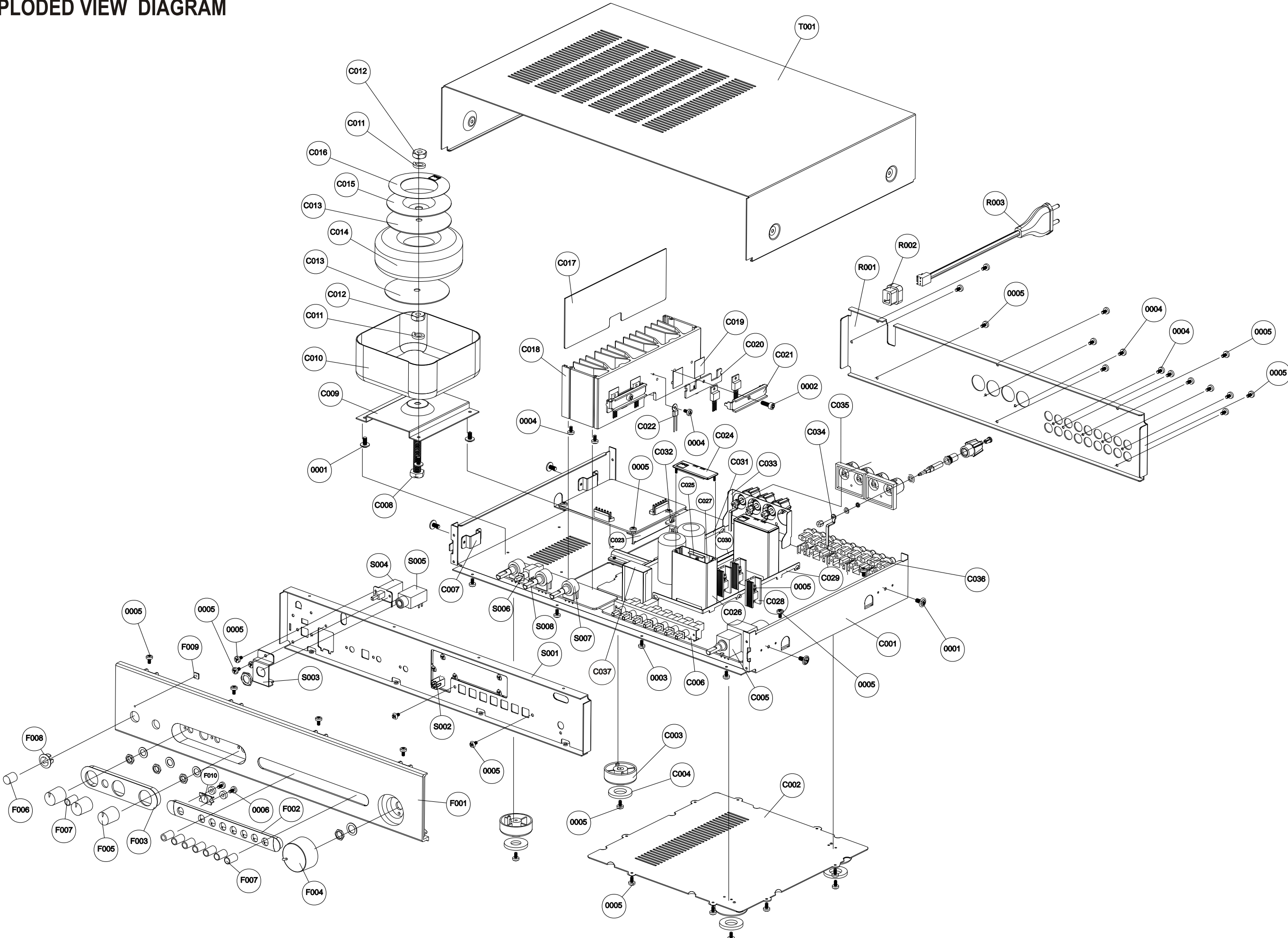

PACKING DIAGRAM

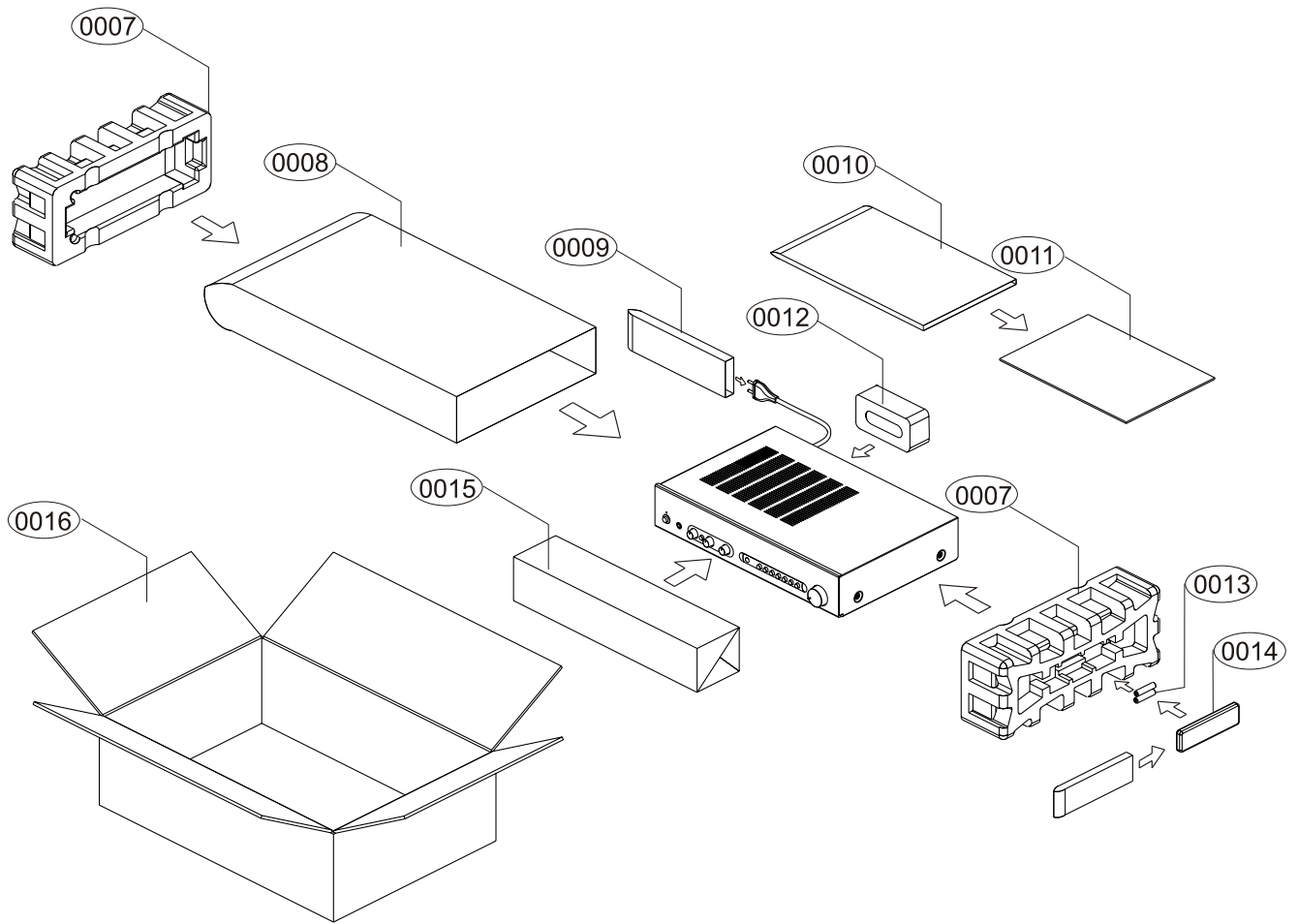

Ref. No.	Part No.	Description	Q'TY
0007.	62-00300-01	Polyfoam End Cap	2
0008.	63-00320-01	Polybag	1
0009.	63-00320-03	AC Cord Polybag	1
0010.	63-00320-02	Manual Polybag	1
0011.	65-00300-01	Instruction Manual	1
0012.	62-00320-01	Polyfoam BDP Unit	1
0013.	31-07150-00	Batteries	2
0014.	30-0C300-00	Remote Control	1
0015.	64-00300-01	EPE Fascia Cover	1
0016.	61-00300-01	Carton Box	1

Proprietary information for servicing purposes only.
 The information herein may not be used commercially without the prior written agreement of NAD International, Toronto, Canada.

SERVICE MANUAL

C 300

STEREO
AMPLIFIER

© NAD 2005

NAD ELECTRONICS INTERNATIONAL
TORONTO