PG-300

SYNTHESIZER PROGRAMMER

The PG-300 is a programmer specially designed for
the α JUNO-1 and the α JUNO-2.

CONTENTS

1 Panel Description	3	3 Application	6
2 Operation	4	1. Controlling the MIDI Sound Module with MIDI Keyboard Recorder	6
1. Power Up	5	2. Changing MIDI Channels	6
2. Tone Edit	5	4 Specifications	7
3. Tone Creation	5		

RADIO AND TELEVISION INTERFERENCE

Warning – This equipment has been verified to comply with the limits for a Class B computing device, pursuant to Subpart J, of Part 15, of FCC Rules. Operation with non-certified or non-verified equipment is likely to result in interference to radio and TV reception.

The equipment described in this manual generates and uses radio-frequency energy. If it is not installed and used properly, that is, in strict accordance with our instructions, it may cause interference with radio and television reception.

This equipment has been tested and found to comply with the limits for a Class B computing device in accordance with the specifications in Subpart J, of Part 15, of FCC Rules. These rules are designed to provide reasonable protection against such a interference in a residential installation.

However, there is no guarantee that the interference to radio or television reception, which can be determined by turning the equipment does cause interference to radio or television reception, which can be determined by turning the equipment on and off, the user is encouraged to try to correct the interference by the following measure:

- Disconnect other devices and their input output cables one at a time. If the interference stops, it is caused by either the other device or its I/O cable. These devices usually require Roland designated shielded I/O cables. For Roland devices, you can obtain the proper shielded cable from your dealer. For non Roland devices, contact the manufacturer or dealer for assistance.

If your equipment does cause interference to radio or television reception, you can try to correct the interference by using one or more of the following measures:

- Turn the TV or radio antenna until the interferences stops.
- Move the equipment to one side or the other of the TV or radio.
- Move the equipment farther away from the TV or radio.
- Plug the equipment into an outlet that is on a different circuit than the TV or radio. (That is, make certain the equipment and the radio or television set are on circuits controlled by different circuit breakers or fuses.)
- Consider installing a rooftop television antenna with coaxial cable lead-in between the antenna and TV.

If necessary, you should consult your dealer or an experienced radio television technician for additional suggestions. You may find helpful the following booklet prepared by the Federal Communications Commission:

"How to Identify and Resolve Radio-TV Interference Problems"

This booklet is available from the U.S. Government Printing Office, Washington, D.C., 20402, Stock No. 004-000-00345-4.

Please read the separate volume "MIDI", before reading this owner's manual.

Copyright © 1985 by ROLAND CORPORATION

All rights reserved. No part of this publication may be reproduced in any form without the written permission of ROLAND CORPORATION.

1 PANEL DESCRIPTION

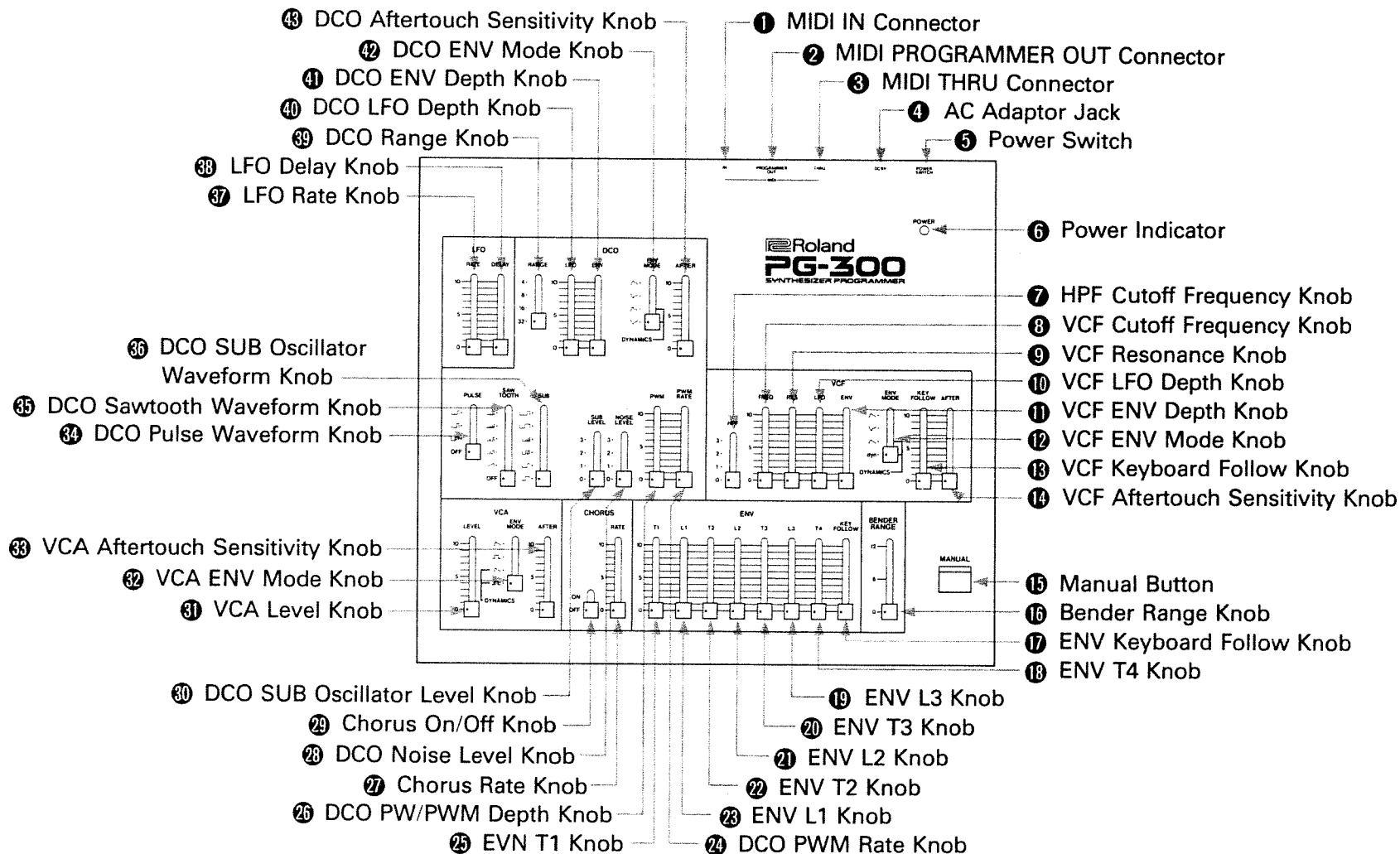

The PG-300 is the programmer specially designed for synthesizing the tone colors of the α JUNO-1 and the α JUNO-2.

By using the PG-300, a tone color can be much more easily and quickly edited or created from scratch.

This tone modifying function of the PG-300 is executed by the MIDI Exclusive messages which are the specific messages used by Roland. Therefore, the PG-300 cannot control the tone colors of other manufacturers' synthesizers. Even the Roland synthesizers cannot be used with the PG-300, unless they can recognize the MIDI Exclusive messages.

Bescheinigung des Herstellers /Importeurs

Hiermit wird bescheinigt, daß der/die/das
ROLAND SYNTHESIZER PROGRAMMER PG-300
(Gerät, Typ. Bezeichnung)

in Übereinstimmung mit den Bestimmungen der
Amtsbl. Vfg 1046 / 1984
(Amtsblattverfügung)

funk-entstört ist.

Der Deutschen Bundespost wurde das Inverkehrbringen dieses Gerätes angezeigt und die Berechtigung zur Überprüfung der Serie auf Einhaltung der Bestimmungen eingeräumt.

Roland Corporation Osaka / Japan
Name des Herstellers/Importeurs

2 OPERATION

To use the PG-300 in the setup with the α JUNO, set the MIDI channel of the α JUNO to 1. (Refer to the α JUNO's owner's manual.)

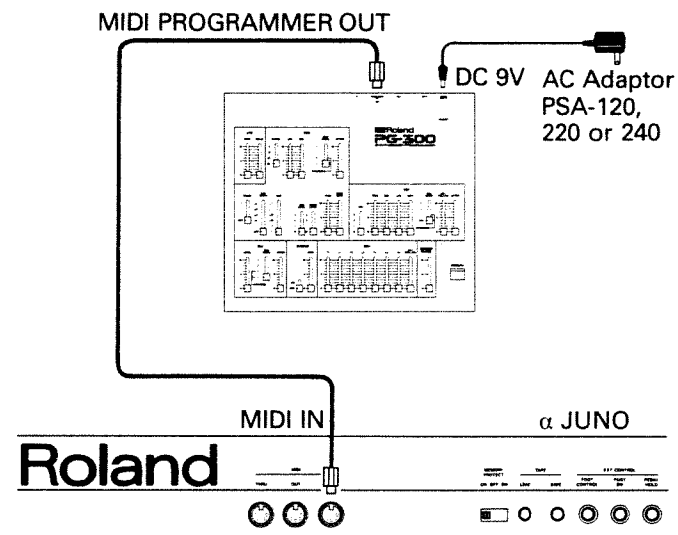

The PG-300 controls the α JUNO's tone colors using the MIDI Exclusive message. So, be sure to turn the MIDI Exclusive message in the α JUNO's MIDI Functions ON.

* Refer to the α JUNO's owner's manual on page 32.

However, it is also possible to set the receive channel of the α JUNO other than 1. (Refer to "Changing MIDI Channels" on page 6.)

1. Power Up

OPERATION

Switch on the α JUNO, then the PG-300.

The Power Indicator ⑥ will light up.

2. Tone Edit

This Tone Edit function is useful for slightly modifying the tone color.

OPERATION

- ① Select the tone color to be modified on the α JUNO.
- ② Using the knobs on the Programmer, edit the tone color.

If you move a desired knob even slightly, its setting position of that tone color will be deleted and ready to be manually controlled.

* This Editing function does not automatically rewrite the existing tone color, therefore, if calling the same tone color later, the unchanged original

tone color will be heard. To retain the edited tone color, take an appropriate writing procedure on the α JUNO.

* While editing a parameter with the PG-300, even if the current set positions of the knobs or switches are exactly what you desire, change the position once then return it. Otherwise, the parameter value might not be affected by the PG-300, thereby remain unchanged.

3. Creating a new Tone Color

This function is useful for synthesizing a tone color from scratch.

OPERATION

Push the Manual Button ⑮.

Now, the whole panel setting of the PG-300 decides the tone color. That is, existing tone color in memory has nothing to do with your sound synthesis. You can make a complete new tone color from scratch.

* The tone color you have synthesized will not be retained unless a proper writing procedure is taken on the α JUNO. The writing operation, however, inevitably erases a tone color.

3 APPLICATION

1. Controlling the α JUNO with MIDI Keyboard Recorder

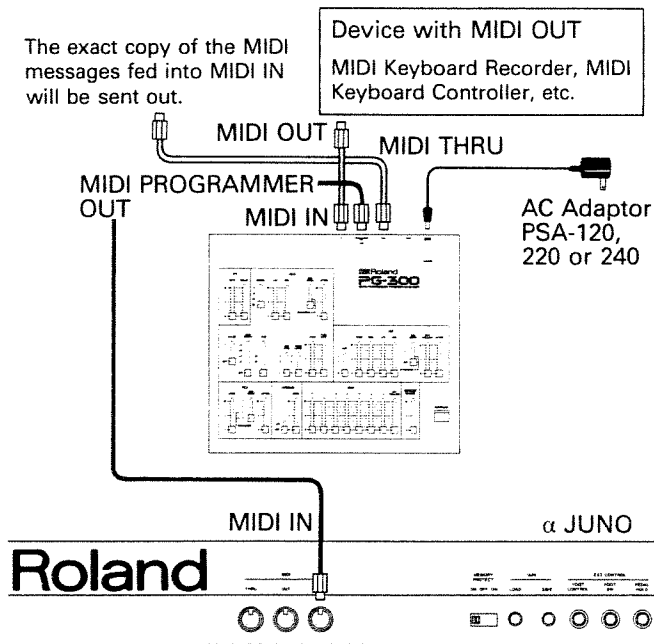

To control the α JUNO with a MIDI device, connect the MIDI OUT of the MIDI device to the MIDI IN Connector ① on the Programmer.

* The PG-300's MIDI messages for tone color editing and the messages fed into the MIDI IN are mixed and sent through the MIDI PROGRAMMER OUT.

2. Changing MIDI Channels

By using the DCO SUB Oscillator Level Knob ⑩ and the DCO Noise Level Knob ⑪, you can set any of the MIDI Channels 1 to 16. (See the Table 1 shown below.)

OPERATION

① Turn the PG-300 off.

With the aid of the table shown below, set the two switches to the appropriate numbers.

	MIDI Channel															
	1	2	3	4	5	6	7	8	9	10	11	12	13	14	15	16
DCO SUB Oscillator Level Knob ⑩	0	0	0	0	1	1	1	1	2	2	2	2	3	3	3	3
DCO Noise Level Knob ⑪	0	1	2	3	0	1	2	3	0	1	2	3	0	1	2	3

* If you switch the PG-300 off while playing the keyboard, various troubles will occur, such as the played keys keep crying even after the keys are released.

② While holding the Manual Button ⑬ down, switch the PG-300 on.

Now, set the α JUNO to the same MIDI Channel as you have set in above operation.

IMPORTANT NOTES

POWER

- When setting up the PG-300 with the α JUNO, turn both of them off.
- This unit might not work properly if turned on immediately after turned off. If this happens, simply turn it off and turn it on again a few seconds later.
- Be sure to use the supplied AC Adaptor. Using any other adaptor may cause trouble.

LOCATION

- Avoid using the α JUNO in excessive heat or humidity or where it may be affected by direct sunlight or dust.

CLEANING

- Clean the unit with only soft cloth and mild detergent.
- Do not use solvents such as THINNER.

Setting Memo

IN PROGRAMMER OUT THRU DCVY POWER SWITCH

POWER

<p>LFO</p> <p>RATE DELAY</p> <p>10 5 0</p>	<p>DCO</p> <p>RANGE LFO ENV</p> <p>4 8 16 32</p> <p>10 5 0</p> <p>ENV MODE AFTER</p> <p>10 5 0</p> <p>DYNAMICS</p>	
<p>PULSE</p> <p>10 5 OFF</p>	<p>SAW TOOTH</p> <p>10 5 OFF</p>	<p>VCF</p> <p>FREQ RES LFO ENV</p> <p>10 5 0</p> <p>HPF</p> <p>3 2 1 0</p> <p>ENV MODE KEY FOLLOW AFTER</p> <p>10 5 0</p> <p>DYNAMICS</p>
<p>VCA</p> <p>LEVEL ENV MODE AFTER</p> <p>10 5 0</p> <p>DYNAMICS</p>	<p>CHORUS</p> <p>RATE</p> <p>10 5 0</p> <p>ON OFF</p>	<p>ENV</p> <p>T1 L1 T2 L2 T3 L3 T4 KEY FOLLOW</p> <p>10 5 0</p> <p>BENDER RANGE</p> <p>12 6 0</p>

MANUAL

Title: _____

Model: _____

Memory, Cartridge () _____

Bank: _____ Patch: _____

Memo: _____

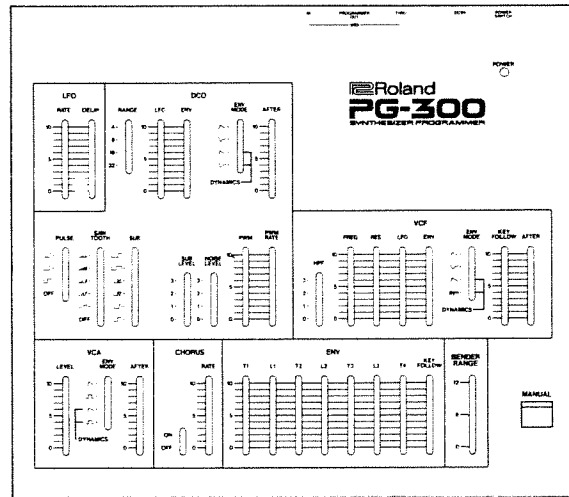
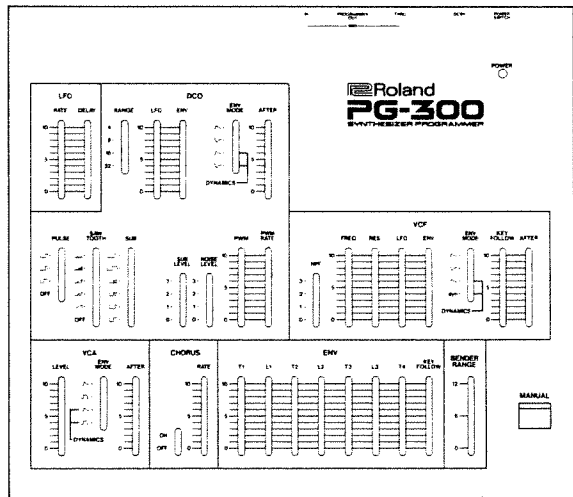
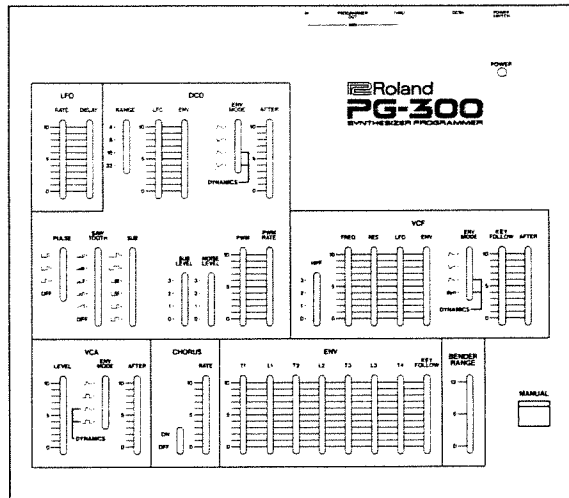
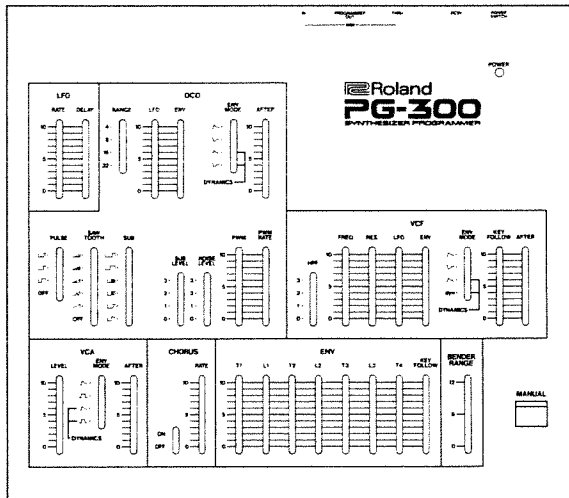

4 SPECIFICATIONS

• Front Panel

- LFO Rate Knob
- LFO Delay Knob
- DCO Range Knob
- DCO LFO Depth Knob
- DCO ENV Depth Knob
- DCO ENV Mode Knob
- DCO Aftertouch Sensitivity Knob
- DCO Pulse Waveform Knob
- DCO Sawtooth Waveform Knob
- DCO SUB Oscillator Waveform Knob
- DCO SUB Oscillator Level Knob
- DCO Noise Level Knob
- DCO PW/PWM Depth Knob
- DCO PWM Rate Knob
- HPF Cutoff Frequency Knob
- VCF Cutoff Frequency Knob
- VCF Resonance Knob
- VCF LFO Depth Knob
- VCF ENV Depth Knob
- VCF ENV Mode Knob
- VCF Keyboard Follow Knob
- VCF Aftertouch Sensitivity Knob
- VCA ENV Mode Knob
- VCA Aftertouch Sensitivity Knob
- VCA Level Knob

Chorus On/Off Knob

Chorus Rate Knob

ENV T1 Knob

ENV L1 Knob

ENV T2 Knob

ENV L2 Knob

ENV T3 Knob

ENV L3 Knob

ENV T4 Knob

ENV Keyboard Follow Knob

Bender Range Knob

Manual Button

Power Indicator

• Rear Panel

Power Switch

AC Adaptor Jack

MIDI IN Connector

MIDI PROGRAMMER OUT Connector

MIDI THRU Connector

• **Consumption** 200 mA (DC 9V)

• **Weight** 1.7 kg/3 lb 12 oz (without the Adaptor)

• **Dimensions** 267(W) × 55(H) × 238(D)mm
10-1/2" × 2-1/8" × 9-1/8"

• **Accessories** AC Adaptor PSA-120, 220 or 240
MIDI/SYNC Cable × 1

MODEL PG-300 MIDI Implementation

1. TRANSMITTED DATA

```

1.1 All received messages. (except Active Sense)
1.2 Created message.
-----
Status Second Third Description
1111 1110 ----- Active Sensing

```

Note : This unit stops transmitting Active Sense message if this unit detects Non Active condition on MIDI IN.

2. RECOGNIZED RECEIVE DATA

```

-----
Status Second Third Description
1111 1110 ----- Active Sensing

```

3. TRANSMITTED EXCLUSIVE MESSAGES

```

3.1 All received Exclusive Messages.
3.2 All Tone Parameters without Tone names ( APR )
When 'MANUAL Button' is pressed.

```

```

-----
Byte Description
a 1111 0000 Exclusive status
b 0100 0001 Roland ID #
c 0011 0101 Operation code = APR (all parameters)
d 0000 nnnn Unit # = MIDI basic channel, nnnn = 0 - 15
e 0010 0011 where nnnn + 1 = channel #
f 0010 0000 Format type ( JU-1, JU-2 )
g 0000 0001 Level # = 1
h 0vvv vvvv Group #
i 0vvv vvvv Value ( 0 - 127 )
j 1111 0111 In sequence (36 bytes total)
End of System Exclusive

```

3.3 Individual Tone Parameter (IPR)

When the volume controllers or switches are changed.

```

-----
Byte Description
a 1111 0000 Exclusive status
b 0100 0001 Roland ID #
c 0011 0110 Operation code = IPR (individual parameter)
d 0000 nnnn Unit # = MIDI basic channel, nnnn = 0 - 15
e 0010 0011 where nnnn + 1 = channel #
f 0010 0000 Format type ( JU-1, JU-2 )
g 0000 0001 Level # = 1
h 00pp pppp Parameter # ( 0 - 35, 48 )
i 0vvv vvvv Value ( 0 - 127 )
j 1111 0111 h and i ( repetitively )
End of System Exclusive

```

Notes :

- *1 Default MIDI basic channel is 1. It can be set to other MIDI basic channels as follows :
- 1. Turn power off.
- 2. Set up the position of 'SUB LEVEL' switch and 'NOISE LEVEL' switch to correspond to MIDI channel #.

MIDI channel # (-> switch table

NOISE LEVEL switch			
S	0	1	2
U	1	2	3
B	2	3	4
L	5	6	7
E	8	9	10
V	11	12	13
L	14	15	16

- 3. Turn power on while holding the 'MANUAL Button' down.

*2 Parameter format

#	Function	Value
0	DCO ENV MODE	0 = ENV normal 1 = ENV inverted with dynamics 2 = ENV normal with dynamics 3 = ENV inverted with dynamics 0 = ENV normal 1 = ENV inverted with dynamics 2 = ENV normal with dynamics 3 = ENV inverted with dynamics
1	VCF ENV MODE	0 = ENV 1 = ENV inverted with dynamics 2 = ENV 3 = ENV with dynamics
2	VCA ENV MODE	0 = ENV 1 = GATE 2 = ENV with dynamics 3 = GATE with dynamics 0 = 3 0 = 5 0 = 4 1 = 8 2 = 16 3 = 32
3	DCO WAVEFORM PULSE	0 = 3 0 = 5
4	DCO WAVEFORM SAMTOOTH	0 = 3 0 = 5
5	DCO WAVEFORM SUB	0 = 3 0 = 5
6	DCO RANGE	0 = 4 1 = 8 2 = 16 3 = 32
7	DCO SUB LEVEL	0 = 3 0 = 5
8	DCO NOISE LEVEL	0 = 3 0 = 5
9	HPE CUTOFF FREQ	0 = OFF 1 = ON
10	CHORUS	0 = OFF 1 = ON
11	DCO LFO MOD DEPTH	0 = 127
12	DCO ENV MOD DEPTH	0 = 127
13	DCO AFTER DEPTH	0 = 127
14	DCO PW/PWM DEPTH	0 = 127
15	DCO PWM RATE	0 = 127 = PW manual 1 = 127 = PWM LFO RATE
16	VCF CUTOFF FREQ	0 = 127
17	VCF RESONANCE	0 = 127
18	VCF LFO MOD DEPTH	0 = 127
19	VCF ENV MOD DEPTH	0 = 127
20	VCF KEY FOLLOW	0 = 127
21	VCF AFTER DEPTH	0 = 127
22	VCA LEVEL	0 = 127
23	VCA AFTER DEPTH	0 = 127
24	LFO RATE	0 = 127
25	LFO DELAY TIME	0 = 127
26	ENV T1	0 = 127 (ATTACK TIME)
27	ENV L1	0 = 127 (ATTACK LEVEL)
28	ENV T2	0 = 127 (BREAK TIME)
29	ENV L2	0 = 127 (BREAK LEVEL)
30	ENV T3	0 = 127 (DEKAY TIME)
31	ENV L3	0 = 127 (DEKAY LEVEL)
32	ENV T4	0 = 127 (SUSTAIN TIME)
33	ENV KEY FOLLOW	0 = 127 (RELEASE TIME)
34	CHORUS RATE	0 = 127
35	BENDER RANGE	0 = 127

MODEL PG-300 MIDI Implementation Chart

Function.....	Transmitted	Recognized	Remarks
Basic Channel	1 ** 1 - 16 **	X X	
Mode	X * *****	X X	
Note Number	* *****	X	
Velocity	* *	X X	
After Touch	* *	X X	
Pitch Bender	*	X	
Control Change			
Prog Change	* *****	X X	
System Exclusive	○	X	Tone parameter
System Common	* * *	X X X	
System Real Time	* *	X X	
Aux Messages	* * ○ *	X X ○ X	
Notes	* : This unit transmits all received MIDI messages except Active Sense. ** : Used as 'Unit #' in Exclusive Messages.		

Mode 1 : OMNI ON, POLY
Mode 3 : OMNI OFF, POLY

Mode 2 : OMNI ON, MONO
Mode 4 : OMNI OFF, MONO

○ : Yes
X : No

Roland®

10203

UPC 10203



10901

Roland®