

Canon

EOS
REBEL T2i
EOS 550D



The “Quick Reference Guide” and “Software Start Guide” are provided at end of this manual.

E

INSTRUCTION
MANUAL

Canon

EOS
REBEL T2i

EOS 550D

INSTRUCTION MANUAL



Introduction

The EOS REBEL T2i/EOS 550D is a high-performance, digital single-lens reflex camera featuring a fine-detail CMOS sensor with 18.0 effective megapixels, DIGIC 4, high-precision and high-speed 9-point AF, approx. 3.7 fps continuous shooting, Live View shooting, and Full HD (Full High-Definition) movie shooting.

The camera is highly responsive for shooting at anytime, provides many functions fitted for advanced shooting, and offers many other features.

Take Test Shots to Familiarize Yourself with the Camera

With a digital camera, you can immediately view the image you have captured. While reading this manual, take a few test shots and see how they come out. You can then better understand the camera.

To avoid botched pictures and accidents, first read the Safety Warnings (p.233, 234) and Handling Precautions (p.12,13).

Testing the Camera Before Use and Liability

After shooting, playback and check whether the images have been properly recorded. If the camera or memory card is faulty and the images cannot be recorded or downloaded to a computer, Canon cannot be held liable for any loss or inconvenience caused.

Copyrights

Copyright laws in your country may prohibit the use of your recorded images of people and certain subjects for anything but private enjoyment. Also be aware that certain public performances, exhibitions, etc., may prohibit photography even for private enjoyment.



This camera is compatible with SD memory cards, SDHC memory cards, and SDXC memory cards. This manual will refer to all these cards as just "card."

*** The camera does not come with a card for recording images.**
Please purchase it separately.

Item Check List

Before starting, check that all the following items have been included with your camera. If anything is missing, contact your dealer.



Camera

(with eyecup and body cap)



**Battery Pack
LP-E8**

(with protective cover)



**Battery Charger
LC-E8/LC-E8E***



**Wide Strap
EW-100DB III**



Interface cable

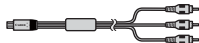

**Stereo AV Cable
AVC-DC400ST**



**EOS DIGITAL
Solution Disk
(Software)**



**Software Instruction
Manual**



**Camera
Instruction Manual
(this booklet)**

* Battery Charger LC-E8 or LC-E8E is provided. (The LC-E8E comes with a power cord.)

- If you purchased a Lens Kit, check that the lens is included.
- Depending on the Lens Kit type, the lens instruction manual might also be included.
- Be careful not to lose any of the above items.

Conventions Used in this Manual

Icons in this Manual



: Indicates the Main Dial.

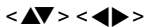

: Indicates the <⬇️⬆️> cross keys.



: Indicates the setting button.

4, 6, 10, 16 : Indicates that the respective function remains active for 4 sec., 6 sec., 10 sec., or 16 sec. respectively after you let go of the button.

* In this manual, the icons and markings indicating the camera's buttons, dials, and settings correspond to the icons and markings on the camera and on the LCD monitor.

MENU : Indicates a function which can be changed by pressing the <MENU> button and changing the setting.

★ : When shown on the upper right of the page, it indicates that the function is available only in the Creative Zone modes (p.20).

(p.**): Reference page numbers for more information.

: Tip or advice for better shooting.

?: Problem-solving advice.

: Warning to prevent shooting problems.

: Supplemental information.

Basic Assumptions

- All operations explained in this manual assume that the power switch has already been set to <ON> (p.27).
- It is assumed that all the menu settings and Custom Functions are set to the default.
- For explanatory purposes, the instructions show the camera attached with an EF-S18-55mm f/3.5-5.6 IS lens.

Chapters



For first-time DSLR users, Chapters 1 and 2 explain the camera's basic operations and shooting procedures.

	Introduction Camera basics.	2
1	Getting Started	23
2	Basic Shooting and Image Playback Fully automatic shooting for different subjects.	45
3	Creative Shooting Basic shooting features for specific types of subjects.	59
4	Advanced Shooting Advanced shooting features.	77
5	Shooting with the LCD Monitor (Live View Shooting)	107
6	Shooting Movies	123
7	Handy Features Convenient menu-based functions.	137
8	Image Playback	155
9	Printing Images	175
10	Customizing the Camera	189
11	Reference	201
	End Pages: Quick Reference Guide and Software Start Guide	243











Contents

Introduction	2
Item Check List.....	3
Conventions Used in this Manual	4
Chapters	5
Contents at a Glance.....	10
Handling Precautions	12
Quick Start Guide	14
Nomenclature	16





1 Getting Started **23**

Charging the Battery	24
Installing and Removing the Battery.....	26
Turning on the Power	27
Setting the Date and Time.....	29
Selecting the Interface Language.....	30
Installing and Removing the SD Card	31
Attaching and Detaching a Lens	33
About the Lens Image Stabilizer.....	35
Basic Operation.....	36
 Using the Quick Control Screen	38
 Menu Operations	40
Formatting the Card.....	42
Switching the LCD Monitor Display	44









2 Basic Shooting and Image Playback **45**

 Fully Automatic Shooting.....	46
 Full Auto Techniques.....	48
 Disabling Flash.....	49
 Shooting Portraits.....	50
 Shooting Landscapes.....	51
 Shooting Close-ups	52
 Shooting Moving Subjects.....	53
 Shooting Portraits at Night	54
 Creative Auto Shooting	55
 Image Playback.....	58

3 Creative Shooting 59

P : Program AE	60
ISO: Changing the ISO Speed	62
 Using the Built-in Flash	64
AF: Changing the AF Mode	66
 Selecting the AF Point	68
MF: Manual Focusing	69
 Continuous Shooting	70
 Using the Self-timer	71
Setting the Image-recording Quality	72
 Selecting a Picture Style	75



4 Advanced Shooting 77

Tv : Action Shots	78
Av : Changing the Depth of Field	80
Depth of Field Preview	82
M : Manual Exposure	83
A-DEP : Automatic Depth-of-Field AE	85
 Changing the Metering Mode	86
Av   Setting Exposure Compensation	87
Auto Exposure Bracketing	89
 Customizing a Picture Style	91
 Registering a Picture Style	94
Setting the Color Space	96
 AE Lock	97
 FE Lock	98
WB : Setting the White Balance	99
 White Balance Correction	101
Auto Lighting Optimizer	103
Lens Peripheral Illumination Correction	104
Preventing Camera Shake	106

5	Shooting with the LCD Monitor (Live View Shooting)	107
	📷 Shooting with the LCD Monitor	108
	Shooting Function Settings	111
	Using AF to Focus	113
	Focusing Manually.....	120
6	Shooting Movies	123
	🎬 Shooting Movies.....	124
	Shooting Function Settings	130
7	Handy Features	137
	Handy Features	138
	Silencing the Beeper	138
	Card Reminder	138
	Setting the Image Review Time	138
	Setting the Auto Power-off Time.....	139
	Adjusting the LCD Monitor Brightness	139
	File Numbering Methods	140
	Auto Rotation of Vertical Images	142
	DISP. Checking Camera Settings.....	143
	Reverting the Camera to the Default Settings.....	144
	Preventing the LCD Monitor from Turning off Automatically	146
	Changing the Shooting Settings Screen Color.....	146
	Setting the Flash	147
	🧼 Automatic Sensor Cleaning	150
	Appending Dust Delete Data	151
	Manual Sensor Cleaning	153
8	Image Playback	155
	🔍📷 Searching for Images Quickly.....	156
	🔍/🔍 Magnified View	158
	🔄 Rotating the Image.....	159
	🎬 Enjoying Movies	160
	🎬 Playing Movies	162
	✂ Editing the Movie's First and Last Scenes	164

Slide Show (Auto Playback).....	165
Viewing the Images on TV	167
 Protecting Images	170
 Erasing Images	171
DISP. Shooting Information Display	173

9 Printing Images 175

Preparing to Print	176
 Printing.....	178
Trimming the Image	183
 Digital Print Order Format (DPOF).....	185
Direct Printing with DPOF	188

10 Customizing the Camera 189

Setting Custom Functions	190
Custom Function Settings	192
Registering My Menu	198
Setting Copyright Information.....	199

11 Reference 201

When Autofocus Fails	202
Using a Household Power Outlet	203
Remote Control Shooting	204
External Speedlites	206
Using Eye-Fi Cards	208
Function Availability Table according to Shooting Modes	210
Menu Settings	212
System Map	216
Troubleshooting Guide.....	218
Error Codes.....	224
Specifications	225
Index	237

End Pages: Quick Reference Guide and Software Start Guide 243



Contents at a Glance

Shooting

- **Shoot automatically** → **p.45 - 57** (Basic Zone modes)
- **Shoot continuously** → **p.50, 53, 70** (📷 Continuous shooting)
- **Take a picture of yourself in a group** → **p.71** (⌚ Self-timer)
- **Freeze the action**
- **Blur the action** → **p.78** (Tv Shutter-priority AE)
- **Blur the background**
- **Keep the background in sharp focus** → **p.80** (Av Aperture-priority AE)
- **Adjust the image brightness (exposure)** → **p.87** (Exposure compensation)
- **Shoot in low light** → **p.46, 62, 64** (⚡ Flash photography)
- **Shoot without flash** → **p.49** (🚫 Flash Off)
- **Photograph fireworks at night** → **p.84** (Bulb exposure)
- **Shoot while viewing the LCD monitor** → **p.108** (📺 Live View shooting)
- **Shoot movies** → **p.124** (🎬 Movie shooting)

Image Quality

- **Shoot with image effects matching the subject** → **p.75** (Selecting a Picture Style)





- **Make a large-size print of the picture** → **p.72** (▲L, ▲L, RAW)
- **Take many pictures** → **p.72** (▲S, ▲S)

Focusing

- **Change the point of focus** → **p.68** (☒ AF point selection)
- **Shoot a moving subject** → **p.53, 67** (AI Servo AF)

Playback

- **View the images with the camera** → **p.58** (▶ Playback)
- **Search for pictures quickly** → **p.156** (☒ Index display)
- **Prevent important images from accidental deletion** → **p.170** (☒ Image protect)
- **Delete unnecessary images** → **p.171** (🗑 Delete)
- **View the images on a TV set** → **p.167** (Video OUT)
- **Set the LCD brightness** → **p.139** (LCD brightness)

Printing

- **Print pictures easily** → **p.175** (Direct printing)



Handling Precautions

Camera Care

- This camera is a precision instrument. Do not drop it or subject it to physical shock.
- The camera is not waterproof and cannot be used underwater. If you accidentally drop the camera into water, promptly consult your nearest Canon Service Center. Wipe off any water droplets with a dry cloth. If the camera has been exposed to salty air, wipe it with a well-wrung wet cloth.
- Never leave the camera near anything having a strong magnetic field such as a magnet or electric motor. Also avoid using or leaving the camera near anything emitting strong radio waves such as a large antenna. Strong magnetic fields can cause camera misoperation or destroy image data.
- Do not leave the camera in excessive heat such as in a car in direct sunlight. High temperatures can cause the camera to malfunction.
- The camera contains precision electronic circuitry. Never attempt to disassemble the camera yourself.
- Use a blower to blow away dust on the lens, viewfinder, reflex mirror, and focusing screen. Do not use cleaners that contain organic solvents to clean the camera body or lens. For stubborn dirt, take the camera to the nearest Canon Service Center.
- Do not touch the camera's electrical contacts with your fingers. This is to prevent the contacts from corroding. Corroded contacts can cause camera misoperation.
- If the camera is suddenly brought in from the cold into a warm room, condensation may form on the camera and internal parts. To prevent condensation, first put the camera in a sealed plastic bag and let it adjust to the warmer temperature before taking it out of the bag.
- If condensation forms on the camera, do not use the camera. This is to avoid damaging the camera. If there is condensation, remove the lens, card and battery from the camera, and wait until the condensation has evaporated before using the camera.
- If the camera will not be used for an extended period, remove the battery and store the camera in a cool, dry, well-ventilated location. Even while the camera is in storage, press the shutter button a few times once in a while to check that the camera is still working.
- Avoid storing the camera where there are corrosive chemicals such as a darkroom or chemical lab.
- If the camera has not been used for an extended period, test all its functions before using it. If you have not used the camera for some time or if there is an important shoot coming up, have the camera checked by your Canon dealer or check the camera yourself and make sure it is working properly.

LCD Monitor

- Although the LCD monitor is manufactured with very high precision technology with over 99.99% effective pixels, there might be a few dead pixels among the remaining 0.01% or less pixels. Dead pixels displaying only black or red, etc., are not a malfunction. They do not affect the images recorded.
- If the LCD monitor is left on for a prolonged period, screen burn-in may occur where you see remnants of what was displayed. However, this is only temporary and will disappear when the camera is left unused for a few days.
- In low or high temperatures, the LCD monitor display may seem slow or it might look black. It will return to normal at room temperature.

Cards

To protect the card and its recorded data, note the following:

- Do not drop, bend, or wet the card. Do not subject it to excessive force, physical shock, or vibration.
- Do not store or use the card near anything having a strong magnetic field such as a TV set, speakers, or magnet. Also avoid places prone to having static electricity.
- Do not leave the card in direct sunlight or near a heat source.
- Store the card in a case.
- Do not store the card in hot, dusty, or humid locations.

Lens

After detaching the lens from the camera, attach the lens caps or put down the lens with the rear end up to avoid scratching the lens surface and electrical contacts.

Contacts



Cautions During Prolonged Use

If you use continuous shooting, Live View shooting, or movie shooting for a prolonged period, the camera may become hot. Although this is not a malfunction, holding the hot camera for a long period can cause slight skin burns.

About smear adhering to the front of the sensor

Besides dust entering the camera from outside, in rare cases lubricant from the camera's internal parts may adhere to the front of the sensor. In case visible spots still remain after the automatic sensor cleaning, having the sensor cleaned by a Canon Service Center is recommended.

6

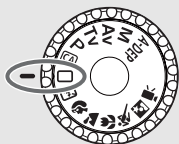

Set the Mode Dial to  (Full Auto). (p.46)

All the necessary camera settings will be set automatically.

7



Focus the subject. (p.37)

Look through the viewfinder and aim the viewfinder center over the subject. Press the shutter button halfway, and the camera will focus the subject. If necessary, the built-in flash will pop-up automatically.

8

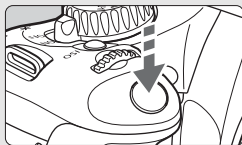

Take the picture. (p.37)

Press the shutter button completely to take the picture.

9



Review the picture. (p.138)

The captured image will be displayed for approx. 2 sec. on the LCD monitor. To display the image again, press the  button (p.58).

- The shooting settings displayed on the LCD monitor will turn off when your eye nears the viewfinder eyepiece.
- To shoot while looking at the LCD monitor, see page 107.
- To delete an image, see “Erasing Images” (p.171).

Nomenclature

The names in bold indicate the parts mentioned up until the “Basic Shooting and Image Playback” section.

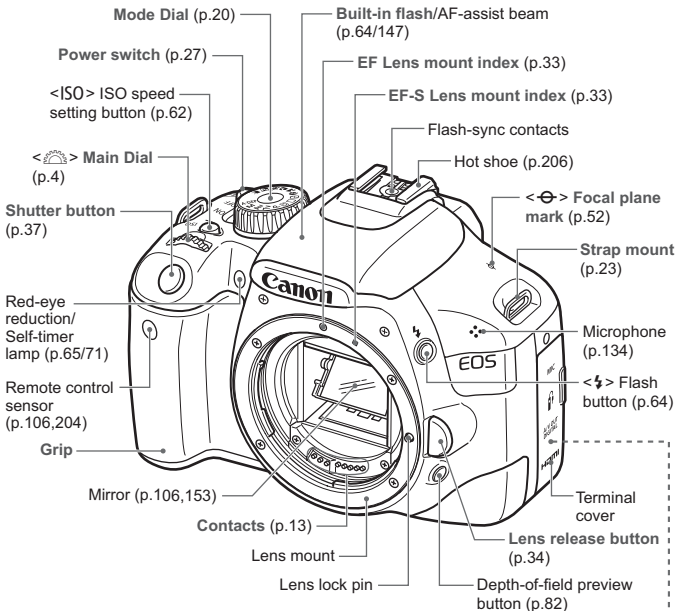

Body cap (p.33)

- External microphone
IN terminal (p.134)
- Remote control
terminal (p.205)
- Audio/video OUT/
Digital terminal (p.169,176)
- HDMI mini OUT
terminal (p.167)

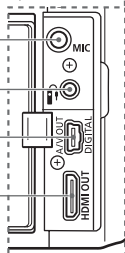

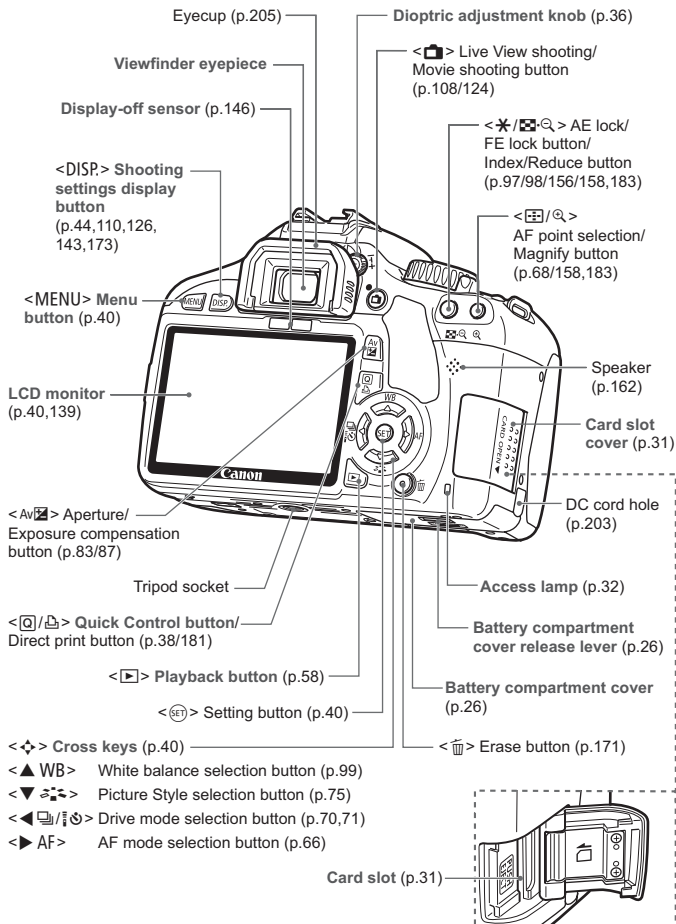

Viewfinder Information

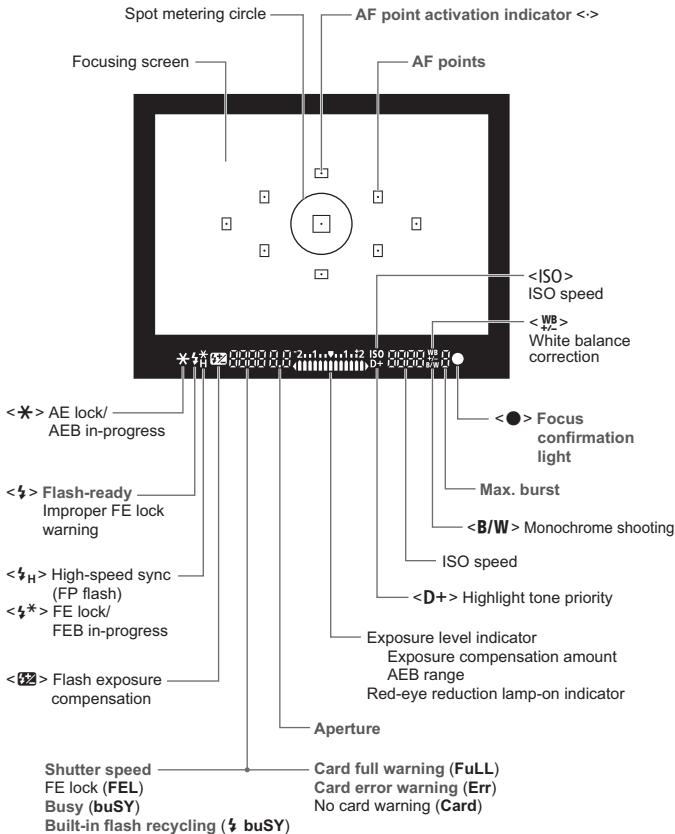

The display will show only the settings currently applied.

Mode Dial

The Mode Dial includes the Basic Zone modes, Creative Zone modes, and Movie shooting mode.

Creative Zone

These modes give you more control for shooting various subjects.

- P** : Program AE (p.60)
- Tv** : Shutter-priority AE (p.78)
- Av** : Aperture-priority AE (p.80)
- M** : Manual exposure (p.83)
- A-DEP**: Automatic depth-of-field AE (p.85)

Basic Zone

All you do is press the shutter button. Fully-automatic shooting suiting the subject.









- : **Full Auto** (p.46)
- : **Creative Auto** (p.55)

Image Zone

- : Flash Off (p.49)
- : Portrait (p.50)
- : Landscape (p.51)
- : Close-up (p.52)
- : Sports (p.53)
- : Night Portrait (p.54)

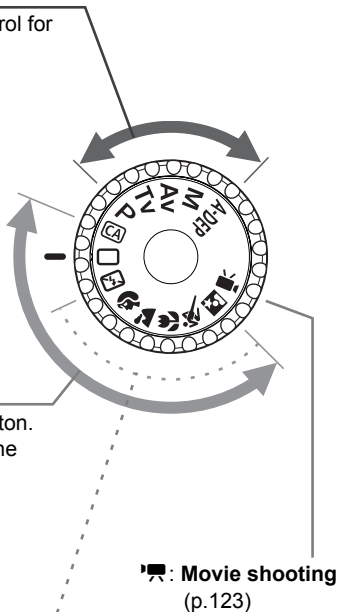

Lens

Lens without a distance scale

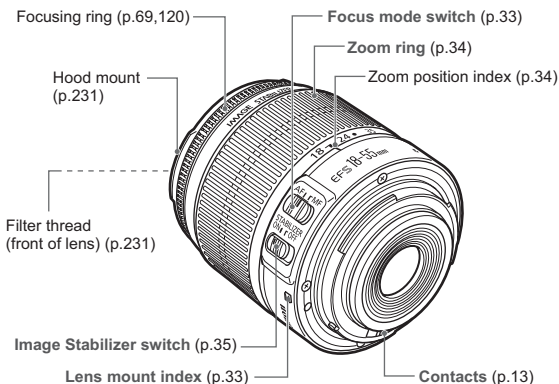

Lens with a distance scale

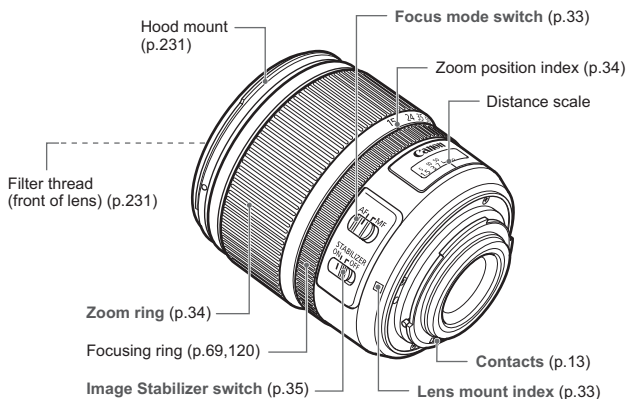

Battery Charger LC-E8

Charger for Battery Pack LP-E8 (p.24).

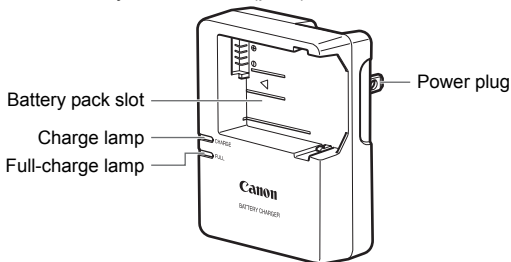

**IMPORTANT SAFETY INSTRUCTIONS-SAVE THESE INSTRUCTIONS.
DANGER-TO REDUCE THE RISK OF FIRE OR ELECTRIC SHOCK,
CAREFULLY FOLLOW THESE INSTRUCTIONS.**

For connection to a supply not in the U.S.A., use an attachment plug adapter of the proper configuration for the power outlet, if needed.

Battery Charger LC-E8E

Charger for Battery Pack LP-E8 (p.24).

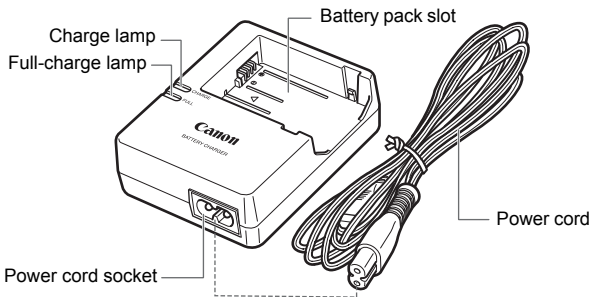

1

Getting Started

This chapter explains preparatory steps before you start shooting and basic camera operations.

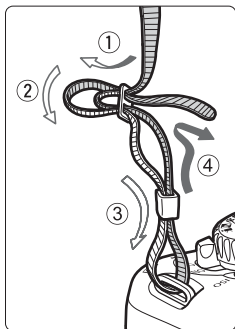

Attaching the Strap

Pass the end of the strap through the camera's strap mount eyelet from the bottom. Then pass it through the strap's buckle as shown in the illustration. Pull the strap to take up any slack and make sure the strap will not loosen from the buckle.

- The eyepiece cover is also attached to the strap (p.205).

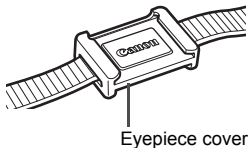

Charging the Battery

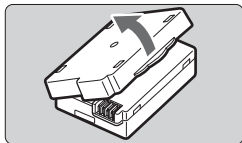

1 Remove the protective cover.

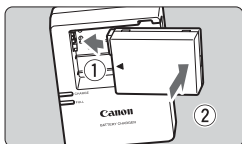

2 Attach the battery.

- As shown in the illustration, attach the battery securely.
- To detach the battery, follow the above procedure in reverse.

LC-E8

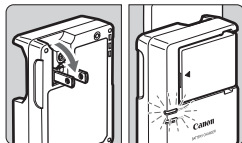

3 Recharge the battery.

For LC-E8

- As shown by the arrow, flip out the battery charger's prongs and insert the prongs into a power outlet.

LC-E8E

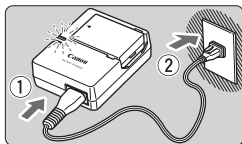

For LC-E8E

- Connect the power cord to the charger and insert the plug into the power outlet.
 - ▶ Recharging starts automatically and the charge lamp turns orange.
 - ▶ When the battery is fully recharged, the full-charge lamp will turn green.
- It takes approx. 2 hours to fully recharge a completely exhausted battery at 23°C / 73°F. The time required to recharge the battery depends on the ambient temperature and battery's charge level.
 - For safety reasons, recharging in low temperatures (6°C - 10°C / 43°F - 50°F) will take a longer time (up to 4 hours).



Tips for Using the Battery and Charger

- **Recharge the battery on the day before or on the day it is to be used.**
Even during storage, a charged battery will gradually discharge and lose its power.
 - **After recharging the battery, detach it and unplug the charger from the power outlet.**
 - **When not using the camera, remove the battery.**
If the battery is left in the camera for a prolonged period, a small amount of power current is released, resulting in excess discharge and shorter battery life. Store the battery with the protective cover attached. Storing the battery after it is fully charged can lower the battery's performance.
 - **The battery charger can also be used in foreign countries.**
The battery charger is compatible with a 100 V AC to 240 V AC 50/60 Hz power source. If necessary, attach a commercially-available plug adapter for the respective country or region. Do not attach any portable voltage transformer to the battery charger. Doing so can damage the battery charger.
 - **If the battery becomes exhausted quickly even after being fully charged, the battery has reached the end of its service life.**
Purchase a new battery.
-
- Do not charge any battery other than the Battery Pack LP-E8.
 - The Battery Pack LP-E8 is dedicated to Canon products only. Using it with an incompatible battery charger or product may result in malfunction or accidents for which Canon cannot be held liable.

Installing and Removing the Battery

Installing the Battery

Load a fully charged Battery Pack LP-E8 into the camera.

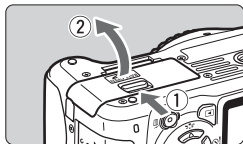

1 Open the battery compartment cover.

- Slide the lever as shown by the arrow and open the cover.

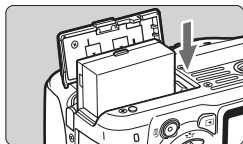

2 Insert the battery.

- Insert the end with the battery contacts.
- Insert the battery until it locks in place.

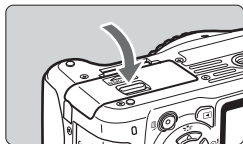

3 Close the cover.

- Press the cover until it snaps shut.

Removing the Battery

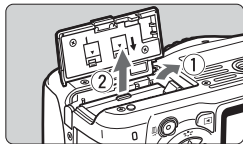

Open the cover and remove the battery.

- Press the battery release lever as shown by the arrow and remove the battery.
- To prevent short circuiting, be sure to attach the protective cover to the battery.

 After opening the battery compartment cover, be careful not to swing it back further. Otherwise, the hinge might break.

Turning on the Power

If the date/time setting screen appears when you turn on the power switch, see page 29 to set the date/time.

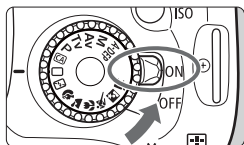

<ON> : The camera turns on.

<OFF> : The camera is turned off and does not operate. Set to this position when not using the camera.

About the Automatic Self-Cleaning Sensor

- Whenever you set the power switch to <ON> or <OFF>, the sensor cleaning will be executed automatically. During the sensor cleaning, the LCD monitor will display <□>. Even during the sensor cleaning, you can still shoot by pressing the shutter button halfway (p.37) to stop the sensor cleaning and take a picture.
- If you repeatedly turn the power switch <ON>/<OFF> at a short interval, the <□> icon might not be displayed. This is normal and not a problem.

About Auto Power Off

- To save battery power, the camera turns off automatically after about 30 seconds of non-operation. To turn on the camera again, just press the shutter button halfway (p.37).
- You can change the auto power-off time with the menu's [**Auto power off**] setting (p.139).



If you set the power switch to <OFF> while an image is being recorded to the card, [**Recording ...**] will be displayed and the power will turn off after the card finishes recording the image.

Checking the Battery Level

When the power switch is set to <ON>, the battery level will be indicated in one of four levels:



 : Battery level is OK.

 : Battery level is slightly down, but adequate power remains.

 : Battery will be exhausted soon.

 : Battery must be recharged.

Battery Life

Temperature	At 23°C / 73°F	At 0°C / 32°F
No Flash	Approx. 550 shots	Approx. 470 shots
50% Flash Use	Approx. 440 shots	Approx. 400 shots

- The figures above are based on a fully-charged Battery Pack LP-E8, no Live View shooting, and CIPA (Camera & Imaging Products Association) testing standards.
- The Battery Grip BG-E8 approximately doubles the number of possible shots with two LP-E8 batteries installed. With size-AA/LR6 alkaline batteries, the number of possible shots at 23°C / 73°F is approx. 470 shots without flash use and approx. 270 shots with 50% flash use.

-  The number of possible shots will decrease with any of the following operations:
 - Pressing the shutter button halfway for a prolonged period.
 - Often activating only the AF without taking a picture.
 - Using the LCD monitor often.
 - Using the lens Image Stabilizer.
- The lens operation is powered by the camera's battery. Depending on the lens used, the number of possible shots may be lower.
- For battery life with Live View shooting, see page 109.

MENU Setting the Date and Time

When you turn on the power for the first time or if the date/time has been reset, the Date/Time setting screen will appear. Follow steps 3 and 4 to set the date/time. **Note that the date/time appended to recorded images will be based on this date/time setting. Be sure to set the correct date/time.**

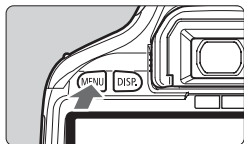

1 Display the menu.

- Press the <MENU> button to display the menu.

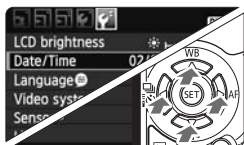

2 Under the [Date/Time] tab, select [Date/Time].

- Press the <◀▶> key to select the [Date/Time] tab.
- Press the <▲▼> key to select [Date/Time], then press <SET>.

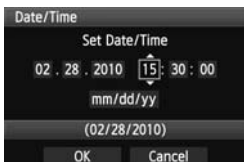

3 Set the date and time.

- Press the <◀▶> key to select the date or time number.
- Press <SET> so <⏸> is displayed.
- Press the <▲▼> key to set the number, then press <SET>. (Returns to □.)

4 Exit the setting.

- Press the <◀▶> key to select [OK], then press <SET>.
- ▶ The date/time will be set.
- Press the <MENU> button to return to the shooting settings display.



- The date/time set will start from when you press <SET> in step 4.
- If you store the camera without the battery or if the camera's battery becomes exhausted, the date/time might be reset. If this happens, set the date/time again.

MENU Selecting the Interface Language

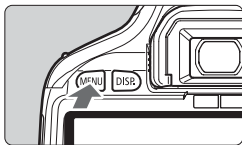

1 Display the menu.

- Press the <MENU> button to display the menu.



2 Under the [Language] tab, select [Language].

- Press the <◀▶> key to select the [Language] tab.
- Press the <▲▼> key to select [Language] (the third item from the top), then press <SET>.



3 Set the desired language.

- Press the <▲▼> key to select the language, then press <SET>.
- ▶ The interface language will change.
- Press the <MENU> button to return to the shooting settings display.

English	Norsk	Română
Deutsch	Svenska	Türkçe
Français	Español	العربية
Nederlands	Ελληνικά	ภาษาไทย
Dansk	Русский	简体中文
Português	Polski	繁體中文
Suomi	Čeština	한국어
Italiano	Magyar	日本語
Українська		

Installing and Removing the SD Card

The captured images are recorded onto the card (sold separately).

- **Make sure the card's write protect switch is set upward to enable writing/erasing.**

Installing the Card

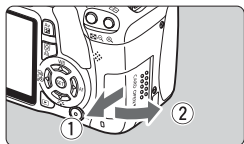

1 Open the cover.

- Slide the cover as shown by the arrow to open it.

Write protect switch

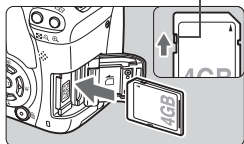

2 Insert the card.

- As shown by the illustration, face the card's label side toward you and insert it until it clicks in place.

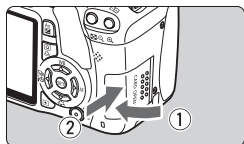

3 Close the cover.

- Close the cover and slide it in the direction shown by the arrow until it snaps shut.
- When you set the power switch to <ON>, the number of possible shots will be displayed on the LCD monitor.



Possible shots



- The number of possible shots depends on the remaining capacity of the card, image-recording quality, ISO speed, etc.
- Setting the [ Release shutter without card] menu option to [Disable] will prevent you from forgetting to install a card (p.138).

Removing the Card

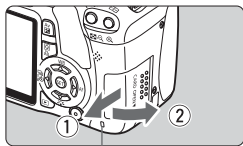

Access lamp

1 Open the cover.

- Set the power switch to <OFF>.
- Check that "Recording..." is not displayed on the LCD monitor.
- **Make sure the access lamp is off, then open the cover.**

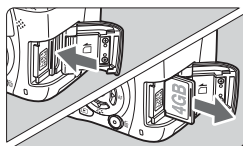

2 Remove the card.

- Gently push in the card, then let go. The card will stick out.
- Pull the card straight out, then close the cover.

- !**
- **When the access lamp is lit or blinking, it indicates that the images are being written to or read by the card, being erased, or data is being transferred. While the access lamp is lit or blinking, never do any of the following. Doing so may damage the image data. It may also damage the card or camera.**
 - Opening the card slot cover.
 - Removing the battery.
 - Shaking or banging the camera around.
 - If the card already contains recorded images, the image number might not start from 0001 (p.140).
 - Do not touch the card's contacts with your fingers or metal objects.
 - If a card-related error message is displayed on the LCD monitor, remove and reinstall the card. If the error persists, use a different card. If you can transfer all the images in the card to a computer, transfer all the images and then format the card with the camera (p.42). The card may then return to normal.

Attaching and Detaching a Lens

Attaching a Lens

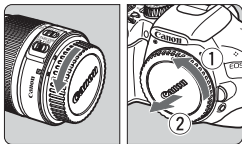

1 Remove the caps.

- Remove the rear lens cap and the body cap by turning them as shown by the arrows.

White index

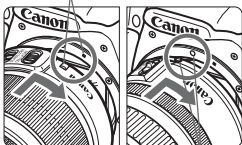

2 Attach the lens.

- Align the lens' red or white index with the camera's index matching the same color. Turn the lens as shown by the arrow until it snaps in place.

Red index

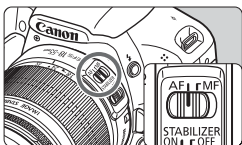

3 On the lens, set the focus mode switch to <AF> (autofocus).

- If it is set to <MF> (manual focus), autofocus will not operate.

4 Remove the front lens cap.

Minimizing Dust

- When changing lenses, do it in a place with minimal dust.
- When storing the camera without a lens attached, be sure to attach the body cap to the camera.
- Remove dust on the body cap before attaching it.

About Zooming

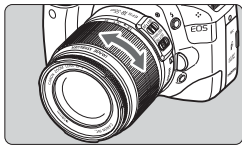

To zoom, turn the zoom ring on the lens with your fingers.

If you want to zoom, do it before focusing. Turning the zoom ring after achieving focus may throw off the focus slightly.

Detaching the Lens

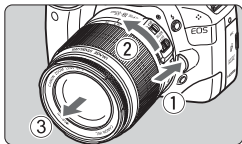

While pressing the lens release button, turn the lens as shown by the arrows.

- Turn the lens until it stops, then detach it.
- Attach the rear lens cap to the detached lens.

- Do not look at the sun directly through any lens. Doing so may cause loss of vision.
- If the front part (focusing ring) of the lens rotates during autofocus, do not touch the rotating part.



Image Conversion Factor

Since the image sensor size is smaller than the 35mm film format, it will look like the lens focal length is increased by 1.6x.

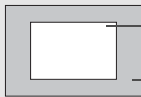

Image sensor size
(22.3 x 14.9 mm / 0.88 x 0.59 in.)

35mm image size
(36 x 24 mm / 1.42 x 0.94 in.)

About the Lens Image Stabilizer

When you use the IS lens' built-in Image Stabilizer, camera shake is corrected to obtain a less blurred shot. The procedure explained here is based on the EF-S18-55mm f/3.5-5.6 IS lens as an example.

* IS stands for Image Stabilizer.

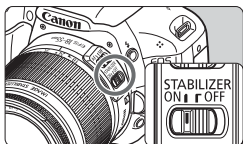

- 1 Set the IS switch to <ON>.**
 - Set also the camera's power switch to <ON>.
- 2 Press the shutter button halfway.**
 - ▶ The Image Stabilizer will operate.
- 3 Take the picture.**
 - When the picture looks steady in the viewfinder, press the shutter button completely to take the picture.

- The Image Stabilizer may not be effective if the subject moves at the time of exposure.
- The Image Stabilizer may not be effective for excessive shaking such as on a rocking boat.

- The Image Stabilizer can operate with the focus mode switch set to either <AF> or <MF>.
- If the camera is mounted on a tripod, you can save battery power by switching the IS switch to <OFF>.
- The Image Stabilizer is effective even when the camera is mounted on a monopod.
- Some IS lenses enable you to switch the IS mode manually to suit the shooting conditions. However, the EF-S18-55mm f/3.5-5.6 IS, EF-S18-55mm f/3.5-5.6 IS II and EF-S18-135mm f/3.5-5.6 IS lenses switch the IS mode automatically.

Basic Operation

Adjusting the Viewfinder Clarity

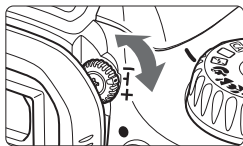

Turn the dioptic adjustment knob.

- Turn the knob left or right until the nine AF points in the viewfinder look sharp.

If the camera's dioptic adjustment still cannot provide a sharp viewfinder image, using Dioptic Adjustment Lens E (10 types, sold separately) is recommended.

Holding the Camera

To obtain sharp images, hold the camera still to minimize camera shake.

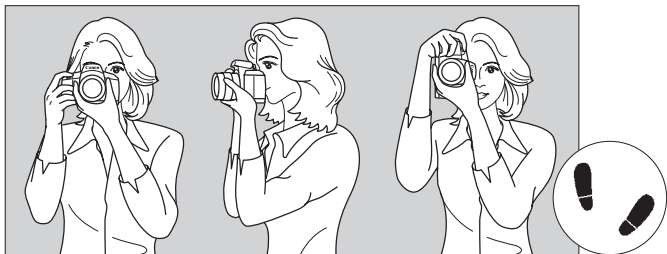

Horizontal shooting

Vertical shooting

1. Wrap your right hand around the camera grip firmly.
2. Hold the lens bottom with your left hand.
3. Press the shutter button lightly with your right hand's index finger.
4. Press your arms and elbows lightly against the front of your body.
5. To maintain a stable stance, place one foot in front of the other.
6. Press the camera against your face and look through the viewfinder.

To shoot while looking at the LCD monitor, see page 107.

Shutter Button

The shutter button has two steps. You can press the shutter button halfway. Then you can further press the shutter button completely.

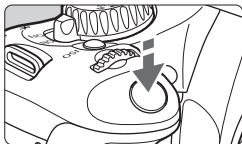

Pressing halfway

This activates autofocus and automatic exposure metering that sets the shutter speed and aperture. The exposure setting (shutter speed and aperture) is displayed in the viewfinder (☼4).

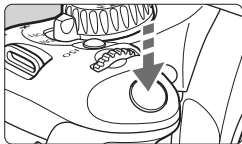

Pressing completely

This releases the shutter and takes the picture.

Preventing Camera Shake

Hand-held camera movement during the moment of exposure is called camera shake. It can cause blurred pictures. To prevent camera shake, note the following:

- Hold and steady the camera as shown on the previous page.
- Press the shutter button halfway to autofocus, then slowly press the shutter button completely.





- If you press the shutter button completely without pressing it halfway first or if you press the shutter button halfway and then press it completely immediately, the camera will take a moment before it takes the picture.
- Even during the menu display, image playback, and image recording, you can instantly go back to shooting-ready by pressing the shutter button halfway.

Using the Quick Control Screen

You can directly select and set the shooting functions displayed on the LCD monitor. This is called the Quick Control screen.



1 Display the Quick Control screen.

- When the shooting settings are displayed, press the  button.
- ▶ The Quick Control screen will activate ().





Basic Zone modes



Creative Zone modes

2 Set the desired setting.

- Press the  key to select the function to be set.
- In the Basic Zone modes (except ), you can select certain drive modes (p.70) and the image-recording quality (p.72).
- ▶ The selected function is displayed on the screen's bottom.
- Turn the  to change the setting.

3 Take the picture.

- Press the shutter button completely to take the picture.

Quick Control Screen Nomenclature

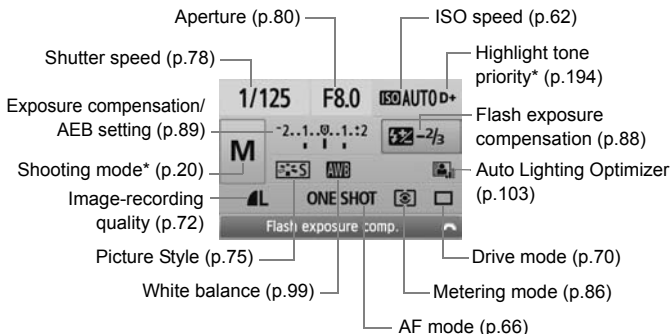

Asterisked functions cannot be set with the Quick Control screen.

Function Setting Display



↓ <SET>

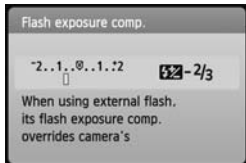

- On the Quick Control screen, select the function and press <SET>. The respective setting screen will then appear (except for the shutter speed and aperture).
- Turn the <ZOOM> dial to change the setting. You can also press the <◀▶> key to change the setting.
- Press <SET> to finalize the setting and return to the Quick Control screen.

MENU Menu Operations

You can set various functions with the menu such as the image-recording quality, date/time, etc. While looking at the LCD monitor, use the <MENU> button, <⬅➡> cross keys, and <SET> button on the camera back.

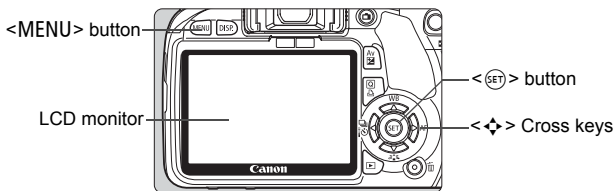

Menu Screen

Basic Zone modes



Movie shooting mode



* In Basic Zone modes and Movie shooting mode, the tabs and menu options displayed will be different.

Creative Zone modes

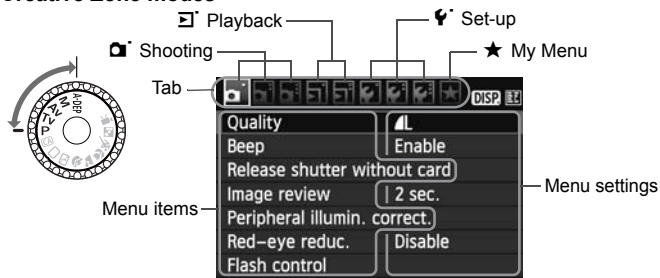

Menu Setting Procedure

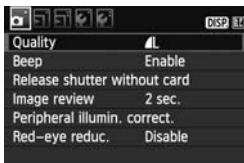

1 Display the menu.

- Press the <MENU> button to display the menu.

2 Select a tab.

- Press the <◀▶> key to select a tab.
- You can also turn the <☀> dial to select a tab.

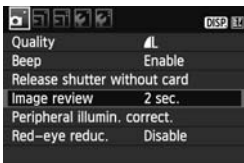

3 Select the desired item.

- Press the <▲▼> key to select the item, then press <SET>.



4 Select the setting.

- Press the <▲▼> or <◀▶> key to select the desired setting. (Some settings require you to press either the <▲▼> or <◀▶> key to select it.)
- The current setting is indicated in blue.

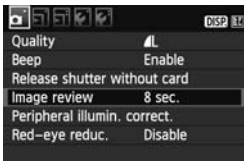

5 Set the desired setting.

- Press <SET> to set it.

6 Exit the setting.

- Press the <MENU> button to return to the shooting settings display.



- The explanation of menu functions hereinafter assumes that you have pressed the <MENU> button to display the menu screen.
- A list of menu functions is on page 212.

MENU Formatting the Card

If the card is new or was previously formatted by another camera or computer, format the card with the camera.

! When the card is formatted, all images and data in the card will be erased. Even protected images will be erased, so make sure there is nothing you need to keep. If necessary, transfer the images to a computer, etc., before formatting the card.

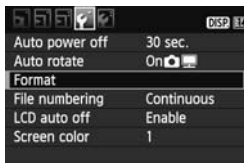

1 Select [Format].

- Under the [**F**] tab, select [**Format**], then press <SET>.

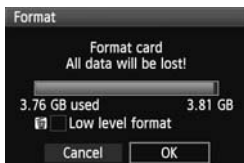

2 Format the card.

- Select [**OK**], then press <SET>.
- ▶ The card will be formatted.
- ▶ When the formatting is completed, the menu will reappear.

- For low-level formatting, press the <[checkmark]> button to checkmark [**Low level format**] with <√>, then select [**OK**].



**Execute [Format] in the following cases:**

- The card is new.
- The card was formatted by a different camera or a computer.
- The card is full with images or data.
- A card-related error is displayed (p.224).

About Low-level Formatting

- Do low-level formatting if the card's recording or reading speed seems slow.
- Since low-level formatting will erase all recordable sectors in the card, the formatting will take slightly longer than normal formatting.
- You can stop the low-level formatting by selecting **[Cancel]**. Even in this case, normal formatting will have been completed and you can use the card as usual.



- When the card is formatted or data is erased, only the file management information is changed. The actual data is not completely erased. Be aware of this when selling or discarding the card. When discarding the card, execute low-level formatting or destroy the card physically to prevent the data from being leaked.
- Before using a new Eye-Fi card, the software in the card must be installed in your computer. Then format the card with the camera.



- The card capacity displayed on the card format screen might be smaller than the capacity indicated on the card.
- This device incorporates exFAT technology licensed from Microsoft.

Switching the LCD Monitor Display

The LCD monitor can display the shooting settings screen, menu screen, image, etc.

Shooting Settings



- Displayed when the camera is turned on.
 - When your eye nears the viewfinder eyepiece, the display-off sensor (p.17, 146) turns off the LCD monitor automatically. This prevents the bright LCD monitor from interfering with your view. The LCD monitor turns on again when your eye leaves the viewfinder eyepiece.
 - While the menu screen or image is displayed as shown below, you can instantly return to the shooting settings screen (shown above) and shoot by pressing the shutter button halfway.
 - Pressing the <DISP.> button turns the display on or off.
- ⚠
- If you look at the viewfinder while wearing sunglasses, the LCD monitor might not turn off automatically. In such a case, press the <DISP.> button to turn off the monitor.
 - If a fluorescent light is nearby, the LCD monitor might turn off. If this happens, take the camera away from the fluorescent light.

Menu Functions

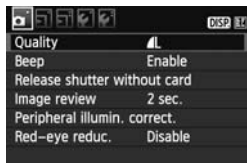

- Appears when you press the <MENU> button. Press the button again to return to the previous screen.

Captured Image



- Appears when you press the <▶> button. Press the button again to return to the previous screen.

2

Basic Shooting and Image Playback

This chapter explains how to use the Basic Zone modes on the Mode Dial for best results and how to playback images.

With the Basic Zone modes, all you do is point and shoot and the camera sets everything automatically (p.210). Also, to prevent botched pictures due to mistaken operations, major shooting settings cannot be changed in the fully-automatic modes. The settings (functions set automatically) which cannot be set by the user are grayed out.

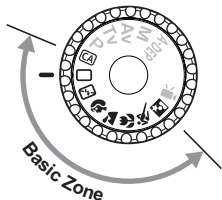

About the Auto Lighting Optimizer

In the Basic Zone modes, the Auto Lighting Optimizer will adjust the image automatically to obtain the optimum brightness and contrast. It is also enabled by default in the Creative Zone modes (p.103).

☐ Fully Automatic Shooting



1 Set the Mode Dial to <☐>.

AF point

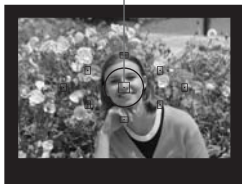

2 Aim any AF point over the subject.

- All the AF points will be used to focus, and generally the closest object will be focused.
- Aiming the center AF point over the subject will make focusing easier.

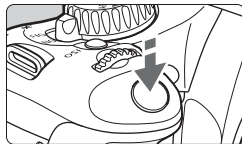

3 Focus the subject.

- Press the shutter button halfway, and the lens will adjust the focus.
- ▶ The dot inside the AF point achieving focus flashes briefly in red. At the same time, the beeper will sound and the focus confirmation light <●> in the viewfinder will light.
- ▶ If necessary, the built-in flash will pop-up automatically.



Focus confirmation light



4 Take the picture.

- Press the shutter button completely to take the picture.
- ▶ The captured image will be displayed for about 2 sec. on the LCD monitor.
- If the built-in flash has popped up, you can push it back down with your fingers.

? FAQ

- **The focus confirmation light <●> blinks and focus is not achieved.**
Aim the AF point over an area having good contrast, then press the shutter button halfway (p.202). If you are too close to the subject, move away and try again.
- **Sometimes multiple AF points flash simultaneously.**
This indicates that focus has been achieved at all those AF points. When the AF point covering the desired subject flashes, take the picture.
- **The beeper continues to beep softly. (The focus confirmation light <●> does not light.)**
It indicates that the camera is focusing continuously on a moving subject. (The focus confirmation light <●> does not light.) While the beeper is beeping, you can press the shutter button completely to shoot a moving subject in focus.
- **Pressing the shutter button halfway does not focus the subject.**
When the focus mode switch on the lens is set to <MF> (Manual Focus), the camera does not focus. Set the focus mode switch to <AF> (Auto Focus).
- **Although it is daylight, the flash popped up.**
For a backlit subject, the flash may pop up to help reduce the subject's dark shadow.
- **In low light, the built-in flash fired a series of flashes.**
Pressing the shutter button halfway may trigger the built-in flash to fire a series of flashes to assist autofocusing. This is called AF-assist beam. It is effective up to approx. 4 meters/13.1 feet away.
- **Although flash was used, the picture came out dark.**
The subject was too far away. The subject should be within 5 meters/16.4 feet from the camera.
- **When flash was used, the bottom part of the picture came out unnaturally dark.**
The subject was too close to the camera, and a shadow was created by the lens barrel. The subject should be at least 1 meter/3.3 feet away from the camera. If a hood has been attached to the lens, remove it before taking the flash picture.

Full Auto Techniques

Recomposing the Shot



Depending on the scene, position the subject toward the left or right to create a balanced background and good perspective.

In the (Full Auto) mode, while you press the shutter button halfway to focus a still subject, the focus will be locked. You can then recompose the shot and press the shutter button completely to take the picture. This is called “focus lock”. Focus lock is also possible in other Basic Zone modes (except  Sports).

Shooting a Moving Subject



In the (Full Auto) mode, if the subject moves (distance to camera changes) during or after you focus, AI Servo AF will take effect to focus the subject continuously. As long as you keep aiming the AF point on the subject while pressing the shutter button halfway, the focusing will be continuous. When you want to take the picture, press the shutter button completely.

Disabling Flash

In places where flash photography is prohibited, use the <> (Flash Off) mode. This mode is also effective for candlelight scenes when you want to capture the ambient light.

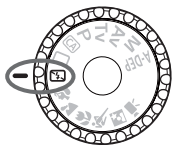

Shooting Tips

- **If the numeric display in the viewfinder blinks, take care to prevent camera shake.**

Under low light when camera shake is prone to occur, the viewfinder's shutter speed display will blink. Hold the camera steady or use a tripod. When using a zoom lens, use the wide-angle end to reduce blur caused by camera shake.

- **Taking portraits without flash.**

Under low light, the person must not move until the picture is taken. If the person moves during the exposure, he or she might look blurred in the picture.

Shooting Portraits

The (Portrait) mode blurs the background to make the human subject stand out. It also makes flesh tones and the hair look softer than with the (Full Auto) mode.

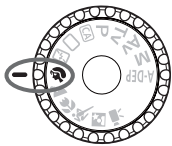

Shooting Tips

- **The farther the distance between the subject and background, the better.**

The further the distance between the subject and background, the more blurred the background will look. The subject will also stand out better in front of a plain, dark background.

- **Use a telephoto lens.**

If you have a zoom lens, use the telephoto end to fill the frame with the subject from the waist up. Move in closer if necessary.



- **Focus the face.**

Check that the AF point covering the face flashes in red.



- If you hold down the shutter button, you can shoot continuously to obtain different poses and facial expressions. (max. approx. 3.7 shots/sec.)
- If necessary, the built-in flash will pop up automatically.

Shooting Landscapes

Use the <> (Landscape) mode for wide scenery, night scenes, or to have everything in focus from near to far. The greens and blues also become more vivid and sharper than with <> (Full Auto).

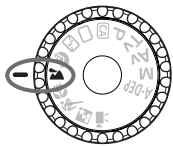



Shooting Tips

- **With a zoom lens, use the wide-angle end.**

When using the wide-angle end of a zoom lens, objects near and far will be in focus better than at the telephoto end. It also adds breadth to landscapes.

- **Shooting night scenes.**

Since the built-in flash will be disabled, this mode <> is also good for night scenes. Use a tripod to prevent camera shake. If you want to photograph a person against a night scene, set the Mode Dial to <> (Night Portrait) and use a tripod (p.54).



Shooting Close-ups

When you want to photograph flowers or small things up close, use the  (Close-up) mode. To make small things appear much larger, use a macro lens (sold separately).

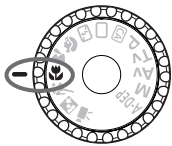



Shooting Tips

- **Use a simple background.**

A simple background makes the flower, etc., stand out better.

- **Move to the subject as close as possible.**

Check the lens for its minimum focusing distance. Some lenses have indications such as  **0.25m/0.8ft**>. The lens minimum focusing distance is measured from the  (focal plane) mark on the camera to the subject. If you are too close to the subject, the focus confirmation light  will blink.

Under low light, the built-in flash will fire. If you are too close to the subject and the bottom of the picture looks dark, move away from the subject.

- **With a zoom lens, use the telephoto end.**

If you have a zoom lens, using the telephoto end will make the subject look larger.

Shooting Moving Subjects

To photograph a moving subject, whether it is a child running or a moving vehicle, use the  (Sports) mode.

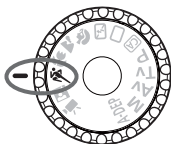

Shooting Tips

- **Use a telephoto lens.**

Using a telephoto lens is recommended so you can shoot from afar.

- **Use the center AF point to focus.**

Aim the center AF point over the subject, then press the shutter button halfway to auto focus. During autofocusing, the beeper will continue beeping softly. If focus cannot be achieved, the focus confirmation light  will blink.

When you want to take the picture, press the shutter button completely. If you hold down the shutter button, continuous shooting (max. approx. 3.7 shots per sec.) and autofocusing will take effect.



Under low light when camera shake is prone to occur, the viewfinder's shutter speed display on the bottom left will blink. Hold the camera steady and shoot.

Shooting Portraits at Night

To shoot someone at night and obtain a natural-looking exposure in the background, use the  (Night Portrait) mode.

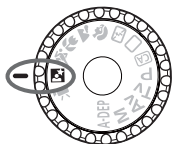

Shooting Tips

- **Use a wide-angle lens and a tripod.**

When using a zoom lens, use the wide-angle end to obtain a wide night view. Also, use a tripod to prevent camera shake.

- **Keep the person within 5 meters/16.4 feet from the camera.**

Under low light, the built-in flash will fire automatically to obtain a good exposure of the person. The effective distance of the built-in flash is 5 meters/16.4 feet from the camera.

- **Shoot also with  (Full Auto).**

Since camera shake is prone to occur with night shots, shooting also with  (Full Auto) is recommended.



- Tell the subject to keep still even after the flash fires.
- If the self-timer is also used, the self-timer lamp will light briefly when the picture is taken.

☐ Creative Auto Shooting

Basic Zone modes except <☐> (Creative Auto) take care of everything, whereas the <☐> Creative Auto mode enables you to easily change the picture's brightness, depth of field, color tone (Picture Style), etc. The default settings are the same as the <☐> (Full Auto) mode.

* CA stands for Creative Auto.

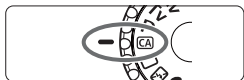

1 Set the Mode Dial to <☐>.

- ▶ The Creative Auto screen appears on the LCD monitor.

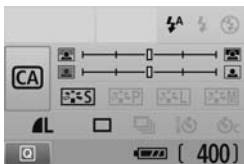

2 Press the <☐> button.

- You can use the <⬆> key to select the function (☉10).
- For details about each function, see page 56-57.



3 Set the desired setting.

- Press the <⬆> key to select the function to be set.
- ▶ A brief description of the selected function is displayed on the screen's bottom.
- Turn the <☉> dial to change the setting.
- Press the shutter button halfway to return to the screen in step 2.

4 Take the picture.

- Press the shutter button completely to take the picture.



If you change the shooting mode or if the power turns off via auto power off (p.139) or by the power switch being set to <OFF>, the Creative Auto settings will revert to the default. However, the image-recording quality, self-timer and remote control settings will be retained.

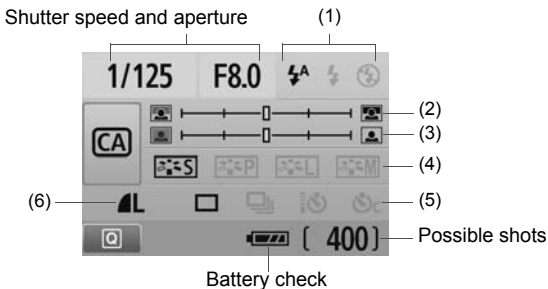

(1) Flash firing



<⚡^A> (Auto flash), <⚡> (Flash on), or <⚡/> (Flash off) can be selected.

If you set <⚡/> (Flash off), see “Disabling Flash” on page 49.

(2) Blurring/sharpening the background

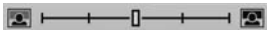

If you move the index mark toward the left, the background will look more blurred. If you move it toward the right, the background will look more in focus. If you want to blur the background, see “Shooting Portraits” on page 50.

Depending on the lens and shooting conditions, the background might not look so blurred. This setting cannot be set (grayed out) while the built-in flash is popped up. When flash is used, it will not be applied.

(3) Adjusting the picture brightness

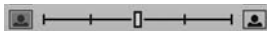

If you move the index mark toward the left, the picture will look darker. If you move it toward the right, the picture will look brighter.

(4) Image effects



Besides the standard image effect, you can set it for portraits, landscapes, or black-and-white photos. (p.75: Picture Style)

< > (Standard): Standard image effect applicable to most scenes.

< > (Smooth skin tones): Effective for close-ups of women or children.

< > (Vivid blues and greens): For impressive landscapes.

< > (Monochrome image): Creates black-and-white photos.

(5) Single, continuous, and self-timer shooting



< > (Continuous shooting): Shoot continuously at a maximum of about 3.7 frames per second (fps).

< > (Self-timer/Remote control): See the “Using the Self-timer” note () on p.71. Remote control shooting is also possible (p.204).

< > (Self-timer:Continuous): After 10 sec., the set number of shots is taken continuously. Press the < > key to set the number of multiple shots (2 to 10) to be taken with the self-timer.

* By pressing < >, you can display the [Drive mode] selection screen and set the same settings.

(6) Image-recording quality



To set the image-recording quality, see “Setting the Image-recording Quality” on page 72-74. By pressing < >, you can display the [Quality] selection screen and set the same settings.

▶ Image Playback

The easiest way to playback images is explained below. For more details on the playback procedure, see page 155.



1 Playback the image.

- When you press the <▶> button, the last captured image will be displayed.



2 Select the image.

- To view images starting with the last image, press the <◀> key.
To view images starting with the first (oldest) image, press the <▶> key.
- Each time you press the <DISP.> button, the display format will change.



With no information displayed



Basic information displayed

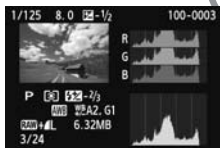

Histogram display



Detailed information display

3 Exit the image playback.

- Press the <▶> button to exit the image playback and return to the shooting settings display.

3

Creative Shooting

In the Basic Zone modes, to prevent spoiled shots, most functions are set automatically and cannot be changed. In the <P> (Program AE) mode, you can set various functions and be more creative.

- In the <P> (Program AE) mode, the camera sets the shutter speed and aperture automatically to obtain a standard exposure.
- The difference between the Basic Zone modes and <P> is explained on page 210.

* <P> stands for Program.

* AE stands for Auto Exposure.

P: Program AE

To obtain a good exposure of the subject, the camera sets the exposure (shutter speed and aperture) automatically. This is called Program AE.



1 Set the Mode Dial to <P>.



2 Focus the subject.

- Look through the viewfinder and aim the selected AF point over the subject. Then press the shutter button halfway.
- ▶ The dot inside the AF point achieving focus flashes briefly in red, and the focus confirmation light <●> in the viewfinder's bottom right lights (with One Shot AF + automatic AF point selection).
- ▶ The shutter speed and aperture will be set automatically and displayed in the viewfinder.



3 Check the shutter speed and aperture display.

- A correct exposure will be obtained as long as the shutter speed and aperture display do not blink.

4 Take the picture.

- Compose the shot and press the shutter button completely.



Shooting Tips

- **Change the ISO speed or use the built-in flash.**

To match the subject and ambient lighting level, you can change the ISO speed (p.62) or use the built-in flash (p.64). In the <P> mode, the built-in flash will not fire automatically. So under low light, press the <⚡> (Flash) button to pop up the built-in flash.

- **The program can be shifted. (Program shift)**

After pressing the shutter button halfway, turn the <☀> dial to change the shutter speed and aperture setting combination (program). After you take the picture, the program shift will be canceled. Program shift is not possible with flash.



In very low light or very bright light, the shutter speed and aperture display will blink when you press the shutter button halfway, as shown in the figure. In low light (**30" 3.5**), either increase the ISO speed (p.62) or use flash (p.64). In bright light (**4000 22**), decrease the ISO speed.



Differences Between <P> and <□> (Full Auto)

With <□>, many functions such the AF mode, drive mode, and built-in flash are set automatically to prevent spoiled shots. The functions you can set are limited. With <P>, only the shutter speed and aperture are set automatically. You can freely set the AF mode, drive mode, built-in flash, and other functions (p.210).

ISO: Changing the ISO Speed ☆

Set the ISO speed (image sensor's sensitivity to light) to suit the ambient light level. In the Basic Zone modes, the ISO speed is set automatically (p.63).

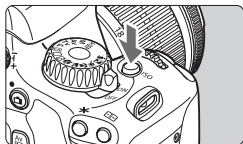

1 Press the <ISO> button. (ⓘ6)

▶ [ISO speed] will appear.

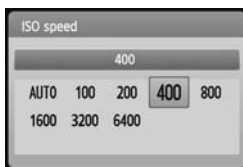

2 Set the ISO speed.

- Turn the <ⓘ6> dial or press the <◀▶> key to select the ISO speed.
- You can also set the ISO speed in the viewfinder while turning the <ⓘ6> dial.
- With "AUTO" selected, the ISO speed will be set automatically (p.63).

ISO Speed Guide

ISO Speed	Shooting Situation (No flash)	Flash Range
100 - 400	Sunny outdoors	The higher the ISO speed, the farther the flash range will be (p.64).
400 - 1600	Overcast skies or evening time	
1600 - 6400, H	Dark indoors or night	

- In the [☛: Custom Functions (C.Fn)] menu, if [Highlight tone priority] is set to [1: Enable], ISO 100 and "H" (equivalent to ISO 12800) settings cannot be set (p.194).
- Using a high ISO speed or shooting in high-temperature conditions may result in more grainy images. Long exposures can also cause irregular colors in the image.
- When you shoot at high ISO speeds, noise (banding, dots of light, etc.) may appear.

☛ In the [☛: Custom Functions (C.Fn)] menu, if [ISO expansion] is set to [1: On], "H" (equivalent to ISO 12800) can also be set (p.192).

About “AUTO” for Automatic ISO Speed

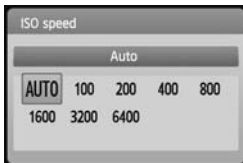

If the ISO speed is set to “**AUTO**”, the actual ISO speed to be set will be displayed when you press the shutter button halfway. As indicated below, the ISO speed will be set automatically to suit the shooting mode.

Shooting Mode	ISO Speed Setting
	Automatically set within ISO 100 - 3200
P/Tv/Av/M/A-DEP	Automatically set within ISO 100 - 6400 ^{*1}
	Fixed at ISO 100
With flash	Fixed at ISO 400 ^{*2*3}

*1: Depending on the maximum ISO speed that has been set.

*2: If fill flash results in overexposure, ISO 100 or a higher ISO will be set.

*3: In the <P/A-DEP> modes and Basic Zone modes <except >, ISO 400 - 1600 will be set automatically if bounce flash is used with an external Speedlite. If the maximum ISO speed has been set to [400] or [800], the ISO speed will be set within this range.

When “**AUTO**” is set, the ISO speed will be displayed in whole-stop increments of 100, 200, 400, 800, 1600, or 3200. However, the actual ISO speed may be set more precisely. Therefore, in the image’s shooting information, you may find an ISO speed like 125 or 640 displayed as the ISO speed.

MENU Setting the Maximum ISO Speed for Auto ISO[☆]

For Auto ISO, you can set the maximum ISO speed within ISO 400 - 6400.



Under the [] tab, select [**ISO Auto**], then press <SET>. Select the ISO speed, then press <SET>.

⚡ Using the Built-in Flash

In indoors, low light, or backlit conditions in daylight, just pop up the built-in flash and press the shutter button to take flash pictures. In the <P> mode, the shutter speed (1/60 sec. - 1/200 sec.) will be set automatically to prevent camera shake.

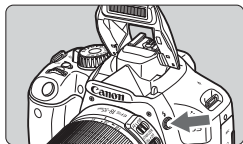

1 Press the <⚡> button.

- In Creative Zone modes, you can press the <⚡> button anytime to take flash pictures.
- While the flash is recycling, “⚡buSY” is displayed in the viewfinder, and [BUSY⚡] is displayed on the LCD monitor.



2 Press the shutter button halfway.

- In the bottom left of the viewfinder, check that the <⚡> icon is lit.

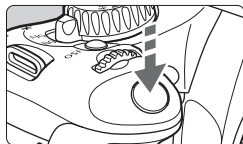

3 Take the picture.

- When focus is achieved and you press the shutter button completely, the flash will fire for the picture.

Effective Flash Range

[Approx. in meters / feet]

ISO Speed	EF-S18-55mm f/3.5-5.6 IS II lens / EF-S18-135mm f/3.5-5.6 IS lens	
	Wide Angle	Telephoto
100	1 - 3.5 / 3.5 - 12	1 - 2.5 / 3.5 - 7.5
200	1 - 5.5 / 3.5 - 17	1 - 3.5 / 3.5 - 11
400/AUTO	1 - 7.5 / 3.5 - 24	1 - 4.5 / 3.5 - 15
800	1 - 11 / 3.5 - 34	1 - 6.5 / 3.5 - 22
1600	1 - 15 / 3.5 - 49	1 - 9.5 / 3.5 - 31
3200	1 - 21 / 3.5 - 69	1 - 13 / 3.5 - 43
6400	1 - 30 / 3.5 - 97	1 - 19 / 3.5 - 61
H: 12800	1 - 42 / 3.5 - 138	1 - 26 / 3.5 - 86



Shooting Tips

- **If the subject is far away, increase the ISO speed.**
By increasing the ISO speed, you can extend the flash range.
- **In bright light, decrease the ISO speed.**
If the exposure setting in the viewfinder blinks, decrease the ISO speed.
- **Detach the lens hood and keep at least 1 meter/3.3 feet away from the subject.**
If the lens has a hood attached or you are too close to the subject, the bottom of the picture might look dark due to the obstructed flash. For important shots, check the image on the LCD monitor to make sure the flash exposure looks good (not dark at the bottom).

MENU Using Red-eye Reduction

Using the red-eye reduction lamp before taking a flash picture can reduce red eye.

Red-eye reduction will work in any shooting mode except .

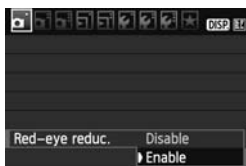

- Under the [] tab, select [**Red-eye reduc.**], then press . Select [**Enable**], then press .
- For flash photography, when you press the shutter button halfway, the red-eye reduction lamp will light. Then when you press the shutter button completely, the picture will be taken.



- The red-eye reduction feature is most effective when the subject looks at the red-eye reduction lamp, when the room is well lit, or when you go closer to the subject.
- When you press the shutter button halfway, the viewfinder display on the bottom will gradually turn off. For best results, take the picture after this display turns off.
- The effectiveness of red-eye reduction varies depending on the subject.



AF: Changing the AF Mode ☆

You can select the AF mode suiting the shooting conditions or subject. In the Basic Zone modes, the optimum AF mode is set automatically.

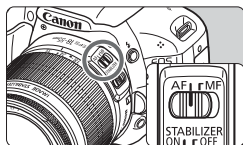

- 1 On the lens, set the focus mode switch to <AF>.

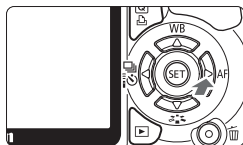

- 2 Press the <▶ AF> button.

▶ [AF mode] will appear.

- 3 Select the AF mode.

- Press the <◀▶> key to select the AF mode, then press <SET>.

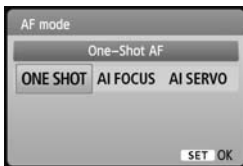

- 4 Focus the subject.

- Aim the AF point over the subject and press the shutter button halfway. The camera will then autofocus in the selected AF mode.

One-Shot AF for Still Subjects

Suited for still subjects. When you press the shutter button halfway, the camera will focus only once.

- When focus is achieved, the dot inside the AF point achieving focus lights briefly in red, and the focus confirmation light <●> in the viewfinder will also light.
- With evaluative metering (p.86), the exposure setting will be set at the same time focus is achieved.
- While you hold down the shutter button halfway, the focus will be locked. You can then recompose the shot if desired.



- If focus cannot be achieved, the focus confirmation light <●> in the viewfinder will blink. If this occurs, a picture cannot be taken even if the shutter button is pressed completely. Recompose the picture and try to focus again. Or see “When Autofocus Fails” (p.202).
- If the [Beep] menu is set to [Disable], the beeper will not sound when focus is achieved.

AI Servo AF for Moving Subjects

This AF mode is for moving subjects when the focusing distance keeps changing. While you hold down the shutter button halfway, the subject will be focused continuously.

- The exposure is set at the moment the picture is taken.
- When the AF point selection (p.68) is automatic, the camera first uses the center AF point to focus. During autofocus, if the subject moves away from the center AF point, focus tracking continues as long as the subject is covered by another AF point.



With AI Servo AF, the beeper will not sound even when focus is achieved. Also, the focus confirmation light <●> in the viewfinder will not light.

AI Focus AF for Automatic Switching of AF Mode

AI Focus AF switches the AF mode from One-Shot AF to AI Servo AF automatically if the still subject starts moving.

- After the subject is focused in the One-Shot AF mode, if the subject starts moving, the camera will detect the movement and change the AF mode automatically to AI Servo AF.



When focus is achieved in the AI Focus AF mode with the Servo mode active, the beeper will sound softly. However, the focus confirmation light <●> in the viewfinder will not light.

Selecting the AF Point ☆

In the Basic Zone modes, all the AF points are active. Generally, the AF point covering the closest subject will be selected to focus. Therefore, the camera sometimes may not focus the subject you want.

With the <P> (Program AE), <Tv>, <Av>, and <M> modes, you can select one AF point to focus where you want.

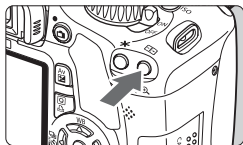



1 Press the < > button. ()

- ▶ The selected AF point will be displayed on the LCD monitor and in the viewfinder.
- When all AF points light up, automatic AF point selection will be set.



2 Select the AF point.

- Press the < > key to select the AF point.
- While looking at the viewfinder, you can select the AF point by turning the < > dial until the desired AF point lights in red.
- Pressing < > toggles the AF point selection between the center AF point and automatic AF point selection.

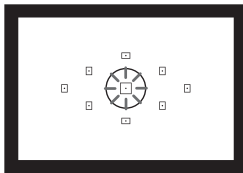

3 Focus the subject.

- Aim the selected AF point over the subject and press the shutter button halfway to focus.

💡 Shooting Tips

- **When shooting a portrait up close, use One-Shot AF and focus the eyes.**
If you focus the eyes first, you can then recompose and the face will remain sharp.
- **If it is difficult to focus, select and use the center AF point.**
The center AF point is the most sensitive among the nine AF points. Also, with a fast lens from f/1.0 to f/2.8, high-precision focusing is possible with the center AF point.
- **To make it easier to focus a moving subject, set the camera to automatic AF point selection and AI Servo AF.**
First use the center AF point to focus. If the subject moves away from the center AF point, the other AF points will continue to focus-track the subject automatically.

MF: Manual Focusing

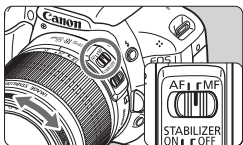

Focusing ring

- 1 **Set the lens focus mode switch to <MF>.**
- 2 **Focus the subject.**
 - Focus by turning the lens focusing ring until the subject looks sharp in the viewfinder.



If you press the shutter button halfway during manual focusing, the AF point achieving focus flashes in red briefly, the beeper sounds, and the focus confirmation light <●> in the viewfinder will light.

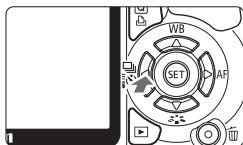

Continuous Shooting ☆

You can shoot up to about 3.7 shots per sec. This is effective for shooting a child running toward you or capturing the different facial expressions.



1 Press the  button.

2 Select .

- Press the  key to select , then press .

3 Take the picture.

- The camera shoots continuously while you hold down the shutter button fully.

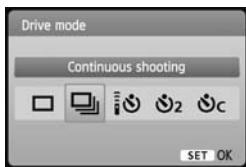

Shooting Tips

- **Also set the AF mode matching the subject.**

- **For moving subject**

When AI Servo AF is set, focusing will be continuous during continuous shooting.

- **For still subjects**

When One-Shot AF is set, the camera will focus only once during continuous shooting.

- **Flash can also be used.**

Since the flash will require recycling time, the continuous shooting speed will be slower.

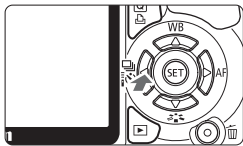

- If the [: Custom Functions (C.Fn)] menu's [**High ISO speed noise reduction**] (p.193) is set to [**2: Strong**], the maximum continuous shooting burst will greatly decrease.
- In AI Servo AF mode, the continuous shooting speed may become slightly slower depending on the subject and the lens used.
- The continuous shooting speed might also decrease indoors and under low light.

Using the Self-timer



1 Press the <  > button.

2 Select the self-timer.

- Press the <  > key to select the desired self-timer, then press <  >.

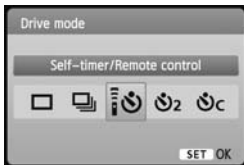

 **10-sec. self-timer**

The remote control can also be used. (p.204)

 **2-sec. self-timer**★ (p.106)

 **10-sec. self-timer plus continuous shots**





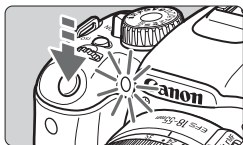

Press the <  > key to set the number of multiple shots (2 to 10) to be taken with the self-timer.



3 Take the picture.

- Look through the viewfinder, focus the subject, then press the shutter button completely.
- ▶ You can check the self-timer operation with the self-timer lamp, beeper, and countdown display (in seconds) on the LCD monitor.
- ▶ Two seconds before the picture is taken, the self-timer lamp will stay on and the beeper will sound faster.

 With <  >, the interval between the multiple shots may be prolonged depending on the shooting functions settings such as the image-recording quality or flash.

-  ● After taking self-timer shots, you should check the image for proper focus and exposure (p.58).
- If you will not look through the viewfinder when you press the shutter button, attach the eyepiece cover (p.205). If stray light enters the viewfinder when the picture is taken, it may throw off the exposure.
- When using the self-timer to shoot only yourself, use focus lock (p.48) on an object at about the same distance as where you will stand.
- To cancel the self-timer after it starts, press the <  > button.

MENU Setting the Image-recording Quality

You can select the number of megapixels to record (approx. 17.9, 8.0, or 4.5 megapixels) and the image quality.

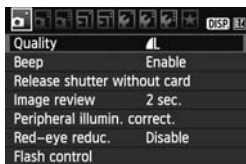

1 Select [Quality].

- Under the [Q] tab, select [Quality], then press <SET>.
- ▶ [Quality] will appear.

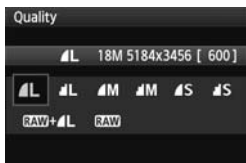

2 Select the image-recording quality.

- For your reference, the respective quality's megapixel count (**M), image size in pixels (****x****), and the number of possible shots [***] will be displayed. Select the desired quality, then press <SET>.

Guide to Image-recording Quality Settings (Approx.)

Quality		Pixels Recorded	File Size (MB)	Possible Shots	Maximum Burst	
L	High quality	JPEG	Approx. 17.9 megapixels (18M)	6.4	570	34
			3.2	1120	1120	
M	Medium quality		Approx. 8.0 megapixels (8M)	3.4	1070	1070
			1.7	2100	2100	
S	Low quality		Approx. 4.5 megapixels (4.5M)	2.2	1670	1670
			1.1	3180	3180	
RAW		High quality	Approx. 17.9 megapixels (18M)	24.5	150	6
RAW + L			24.5+6.4	110	3	

* Based on Canon's testing standards with a 4GB card, ISO 100, and Standard Picture Style.

* The file size, number of possible shots, and maximum burst will vary depending on the subject, card brand, ISO speed, Custom Functions, and other settings.

FAQ

- **I want to select the image-recording quality matching the paper size for printing.**

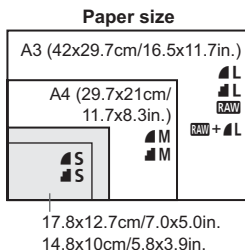

Refer to the diagram on the left when choosing the image-recording quality. If you want to crop the image, selecting a higher quality (more pixels) such as **L**, **L**, **L**, **RAW**, or **RAW+L** is recommended.

- **What's the difference between **L** and **L**?**
It indicates a different image quality due to a different compression rate. Even with the same number of pixels, the **L** image has higher image quality. If **L** is selected, the image quality will be slightly lower, but more images can be saved to the card.
- **I took more shots than the number of possible shots indicated.**
Depending on the shooting conditions, you may be able to take more shots than was indicated. Or, it might be fewer than indicated. The number of possible shots displayed is only an estimate.
- **Does the camera display the maximum burst?**
The maximum burst is displayed in the viewfinder's right side. Since it is only a single-digit indicator 0 - 9, any number higher than 9 will be displayed only as "9." Note that this number will also be displayed even when no card is installed in the camera. Be careful not to shoot without a card in the camera.
- **When should I use **RAW**?**
RAW images require processing with your computer. For details, see "About **RAW**" and "About **RAW+L**" on the next page. Other than **RAW**, the images will be in the JPEG type commonly used in digital cameras.

About RAW

RAW is the raw image data before it is made into L or other images. Although RAW images require software like Digital Photo Professional (provided) so they can be displayed on the computer, they also offer flexibility for image adjustments possible only with RAW. RAW is effective when you want to precisely adjust the image yourself or shoot an important subject.

About RAW + L

RAW + L records both a RAW and L image with a single shot. The two images are saved to the card simultaneously. The two images will be saved in the same folder with the same file numbers (file extension .JPG for JPEG and .CR2 for RAW). L images can be viewed or printed even with a computer which does not have the camera's provided software.

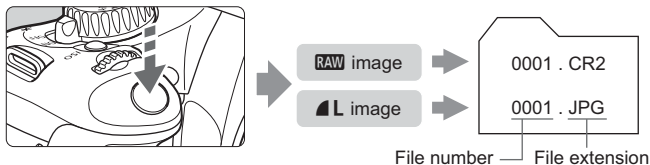

! RAW, RAW + L and [C.Fn: Custom Functions (C.Fn)] menu's [High ISO speed noise reduction]

Although the [C.Fn: Custom Functions (C.Fn)] menu's [High ISO speed noise reduction] (p.193) settings (Standard/Low/Strong/Disable) are applied to the recorded images, the images are displayed without noise reduction during image playback (on the LCD monitor and on a TV screen) or direct printing. (Noise may be noticeable in the images.) You can check the noise reduction effect or print noise-reduced images with Digital Photo Professional (provided software).

Commercially-available software might not be able to display RAW images. Using the provided software is recommended.

Selecting a Picture Style ☆

By selecting a Picture Style, you can obtain image effects matching your photographic expression or the subject.

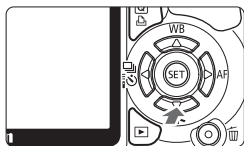

1 Press the <▼ > button.

- ▶ [Picture Style] will appear.



2 Select a Picture Style.

- Press the <◀▶> key to select a Picture Style, then press <SET>.

3 Take the picture.

- Focus and press the shutter button completely. The picture will be taken with the selected Picture Style applied.

Picture Style Effects

Standard (CA): Standard)

The image looks vivid, sharp, and crisp. This is a general-purpose Picture Style suitable for most scenes.

Portrait (CA): Smooth skin tones)

For nice skin tones. The image looks softer. Effective for close-ups of women or children. This Picture Style is also selected automatically when the Mode Dial is set to <👤>.

By changing the [Color tone] (p.92), you can adjust the skin tone.

Landscape (CA): Vivid blues and greens)

For vivid blues and greens, and very sharp and crisp images. Effective for impressive landscapes. This Picture Style is also selected automatically when the Mode Dial is set to <🏞️>.

Neutral

This Picture Style is for users who prefer to process images with their computer. For natural colors and subdued images.

Faithful

This Picture Style is for users who prefer to process images with their computer. When the subject is captured under a color temperature of 5200K, the color is adjusted colorimetrically to match the subject's color. The image is dull and subdued.

Monochrome (CA: Monochrome image)

Creates black-and-white images.



Other than with **RAW**, the black-and-white image cannot be reverted to color. If you want to later shoot pictures in color, make sure the **[Monochrome]** setting has been canceled. When **[Monochrome]** is selected, <**B/W**> will appear in the viewfinder.

User Def. 1-3

You can register a basic style such as **[Portrait]**, **[Landscape]**, a Picture Style file, etc., and adjust it as desired (p.91). Any User Defined Picture Style which has not been set will have the same settings as the Standard Picture Style.

4

Advanced Shooting

This chapter builds on the previous chapter and introduces more ways to shoot creatively.



- The first half of this chapter explains how to use the <Tv> <Av> <M> <A-DEP> modes on the Mode Dial. Except for <A-DEP>, all the shooting modes can be used in combination with the functions introduced in Chapter 3.
- The second half of this chapter, starting with “Changing the Metering Mode” explains the methods to adjust the exposure and the Picture Styles. All the functions introduced in this chapter can also be used with the <P> (Program AE) mode introduced in Chapter 3.

About the Main Dial Pointer

 1/125 

 F8.0 

 -2..1..0..1..:2 

The pointer icon <  > displayed together with the shutter speed, aperture setting, or exposure compensation amount indicates that you can turn the <  > dial to adjust the respective setting.

Tv: Action Shots

You can either freeze the action or create motion blur with the **<Tv>** (Shutter-priority AE) mode on the Mode Dial.

* **<Tv>** stands for Time value.



Frozen action
(Fast shutter speed: 1/2000 sec.)



Blurred motion
(Slow shutter speed: 1/30 sec.)



1 Set the Mode Dial to **<Tv>**.

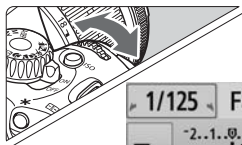

2 Set the desired shutter speed.

- See “Shooting Tips” for advice on setting the shutter speed.
- Turning the  dial to the right sets a faster shutter speed, and turning it to the left sets a slower one.



3 Take the picture.

- When you focus and press the shutter button completely, the picture will be taken at the selected shutter speed.



Shutter Speed Display

The LCD monitor displays the shutter speed as a fraction. However, the viewfinder displays only the denominator. Also, “0”5” indicates 0.5 sec. and “15” is 15 sec.



Shooting Tips

- **To freeze the action or moving subject.**

Use a fast shutter speed such as 1/4000 sec. to 1/500 sec.

- **To blur a running child or animal giving the impression of fast movement.**

Use a medium shutter speed such as 1/250 sec. to 1/30 sec. Follow the moving subject through the viewfinder and press the shutter button to take the picture. If you use a telephoto lens, hold it steady to prevent camera shake.

- **How to blur a flowing river or water fountain.**

Use a slow shutter speed of 1/15 sec. or slower. Use a tripod to prevent camera shake.

- **Set the shutter speed so that the aperture display does not blink in the viewfinder.**

If you press the shutter button halfway and change the shutter speed while the aperture is displayed, the aperture display will also change to maintain the same exposure (amount of light reaching the image sensor). If you exceed the adjustable aperture range, the aperture display will blink to indicate that the standard exposure cannot be obtained.

If the exposure will be too dark, the maximum aperture (smallest number) will blink. If this happens, turn the  dial to the left to set a slower shutter speed or increase the ISO speed.

If the exposure will be too bright, the minimum aperture (highest number) will blink. If this happens, turn the  dial to the right to set a faster shutter speed or decrease the ISO speed.



Using the Built-in Flash

To obtain a correct flash exposure, the flash output will be set automatically (autoflash exposure) to match the automatically-set aperture. The flash sync speed can be set from 1/200 sec. to 30 sec.

Av: Changing the Depth of Field

To obtain a blurry background or to make everything near and far look sharp, set the Mode Dial to <Av> (Aperture-priority AE) to adjust the depth of field (range of acceptable focus).

* <Av> stands for Aperture value which is the size of the diaphragm hole inside the lens.



Sharp foreground and background
(With a high aperture f-number: f/32)



Blurred background
(With a low aperture f-number: f/5.6)



1 Set the Mode Dial to <Av>.

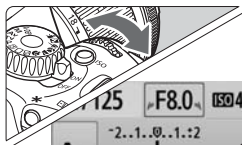

2 Set the desired aperture.

- The higher the aperture f-number, the sharper the picture will look with a wider depth of field.
- Turning the <⚙> dial to the right will set a higher f-number, and turning it to the left will set a lower f-number.



3 Take the picture.

- Focus and press the shutter button completely. The picture will be taken with the selected aperture.



Aperture Display

The higher the f-number, the smaller the aperture opening will be. The apertures displayed will differ depending on the lens. If no lens is attached to the camera, "00" will be displayed for the aperture.

 **Shooting Tips**

- **When using an aperture with a high f-number, note that camera shake can occur in low light scenes.**

A higher aperture f-number will make the shutter speed slower. Under low light, the shutter speed can be as long as 30 sec. In such cases, increase the ISO speed and hold the camera steady or use a tripod.

- **The depth of field depends not only on the aperture, but also the lens and subject distance.**

Since wide-angle lenses have a wide depth of field (range of acceptable focus in front of and behind the point of focus), you need not set a high aperture f-number to obtain a sharp picture from the foreground to the background. On the other hand, a telephoto lens has a narrow depth of field.

And the closer the subject, the narrower the depth of field. A farther subject will have a wider depth of field.

- **Set the aperture so that the shutter speed display does not blink in the viewfinder.**

If you press the shutter button halfway and change the aperture while the shutter speed is displayed, the shutter speed display will also change to maintain the same exposure (amount of light reaching the image sensor). If you exceed the adjustable shutter speed range, the shutter speed display will blink to indicate that the standard exposure cannot be obtained.

If the picture will be too dark, the “30” (30 sec.) shutter speed display will blink. If this happens, turn the  dial to the left to set a lower aperture f-number or increase the ISO speed.

If the picture will be too bright, the “4000” (1/4000 sec.) shutter speed display will blink. If this happens, turn the  dial to the right to set a higher aperture f-number or decrease the ISO speed.

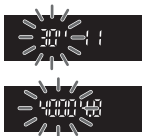

Using the Built-in Flash

To obtain a correct flash exposure, the flash output will be set automatically to match the set aperture (autoflash exposure). The shutter speed will be set automatically between 1/200 sec. - 30 sec. to suit the scene's brightness.

In low light, the main subject is exposed with the automatic flash, and the background is exposed with a slow shutter speed set automatically. Both the subject and background look properly exposed (automatic slow-speed flash sync). If you are handholding the camera, keep it steady to prevent camera shake. Using a tripod is recommended.

If you do not want a slow shutter speed to be used, set the [**F**: Custom Functions (C.Fn)] menu's [**Flash sync. speed in Av mode**] to [**1: 1/200-1/60 sec. auto**] or [**2: 1/200 sec. (fixed)**] (p.192).

Depth of Field Preview ☆

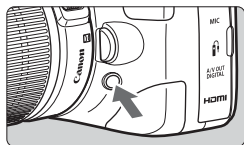

Press the depth-of-field preview button to stop down to the lens's current aperture setting. You can then check the depth of field (range of acceptable focus) through the viewfinder.

 The depth-of-field effect can be clearly seen on the Live View image as you change the aperture and press the depth-of-field preview button (p.112).

M: Manual Exposure

You can set both the shutter speed and aperture manually as desired. With flash, the flash exposure will be set automatically to match the aperture that was set. The flash sync speed can be set within 1/200 sec. to 1/30 sec. or to bulb.

* <M> stands for Manual.



1 Set the Mode Dial to <M>.



2 Set the shutter speed and aperture.

- To set the shutter speed, turn the <⚙> dial.
- To set the aperture, hold down the <Av/□> button and turn the <⚙> dial.

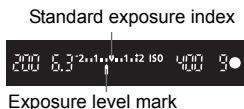



3 Set the exposure and take the picture.

- The exposure level indicator in the viewfinder indicates the exposure level up to ± 2 stops from the standard exposure index at the center. While you change the shutter speed and aperture, the exposure level mark will move. You can decide which exposure level to set. If the amount set exceeds ± 2 stops, the end of the exposure level indicator will display <◀> or <▶>.

⚠ If the [Auto Lighting Optimizer] (p.103) is set to anything other than [Disable], the image may still look bright even if a darker exposure has been set.

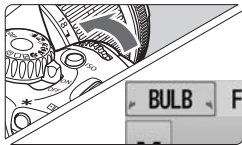
Bulb Exposures



In step 2 on the preceding page, turn the <  > dial to the left to set <BULB>. A bulb exposure keeps the shutter open for as long as you hold down the shutter button. It can be used to photograph fireworks, etc. The elapsed exposure time will be displayed on the LCD monitor.

- Since bulb exposures produce more noise than usual, the image might look a little grainy.
- You can reduce this noise by setting the [: **Custom Functions (C.Fn)**] menu's [**Long exp. noise reduction**] to [**1: Auto**] or [**2: On**] (p.193).

- For bulb exposures, using a tripod and Remote Switch (p.204, 205) is recommended.
- You can also use a remote controller (sold separately, p.204) for bulb exposures. When you press the remote controller's transmit button, the bulb exposure will start immediately or 2 sec. later. Press the button again to stop the bulb exposure.

A-DEP: Automatic Depth-of-Field AE

Objects in the foreground and background will be in focus automatically. All the AF points will function to detect the subject, and the aperture required to attain the necessary depth of field will be set automatically.

* <A-DEP> stands for Auto-Depth of field. This mode sets the depth of field automatically.



1 Set the Mode Dial to <A-DEP>.



2 Focus the subject.

- Aim the AF points over the subjects and press the shutter button halfway (ⓘ4).
- All the subjects covered by the AF points flashing in red will be in focus.

3 Take the picture.



FAQ

- **The aperture display in the viewfinder blinks.**
The exposure is correct, but the desired depth of field cannot be obtained. Either use a wide-angle lens or move farther away from the subjects.
- **The shutter speed display in the viewfinder blinks.**
If the "30" shutter speed blinks, it means that the subject is too dark. Increase the ISO speed. If the "4000" shutter speed blinks, it means that the subject is too bright. Decrease the ISO speed.
- **A slow shutter speed has been set.**
Use a tripod to steady the camera.
- **I want to use flash.**
Flash can be used, however, the result will be the same as using the <P> mode with flash. The desired depth of field will not be obtained.

Changing the Metering Mode ☆

The metering mode measures the subject's brightness to determine the correct exposure. Normally, evaluative metering is recommended.

1 Select [Metering mode].

- Under the [] tab, select [Metering mode], then press <SET>.

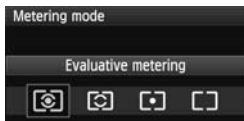

2 Set the metering mode.

- Press the <◀▶> key to select the metering mode, then press <SET>.

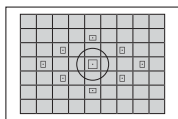

Evaluative metering

This is an all-around metering mode suited for portraits and even backlit subjects. The camera sets the exposure automatically to suit the scene. This metering mode is set automatically in Basic Zone modes.

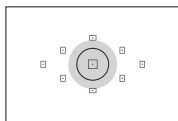

Partial metering

Effective when the background is much brighter than the subject due to backlighting, etc. The gray area in the figure is where the brightness is metered to obtain the standard exposure.

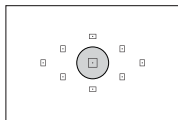

Spot metering

This is for metering a specific part of the subject or scene. The gray area in the left figure is where the brightness is metered to obtain the standard exposure. This metering mode is for advanced users.

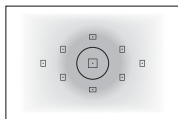

Center-weighted average metering

The brightness is metered at the center and then averaged for the entire scene. This metering mode is for advanced users.

Setting Exposure Compensation [☆]

Av Setting Exposure Compensation

Set exposure compensation if the exposure (without flash) does not come out as desired. This feature can be used in Creative Zone modes (except <M>). Although you can set the exposure compensation up to ± 5 stops in 1/3-stop increments, the exposure compensation indicator in the viewfinder can only display the setting up to ± 2 stops. If you want to set the exposure compensation beyond ± 2 stops, you should follow the instructions for [ **Exp. comp./AEB**] on page 89.

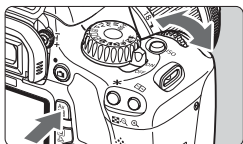

Increased exposure for a brighter image

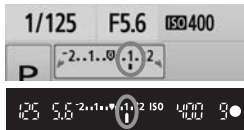

Decreased exposure for a darker image





Dark exposure





Brighter with increased exposure



Making it brighter:

Hold down the <Av  > button and turn the < > dial to the right.
(Increased exposure)

Making it darker:

Hold down the <Av  > button and turn the < > dial to the left.
(Decreased exposure)

- ▶ As shown in the figure, the exposure level is displayed on the LCD monitor and in the viewfinder.

- **After taking the picture, hold down the <Av  > button and turn the < > dial to reset the exposure compensation to zero.**



If the amount set exceeds ± 2 stops, the end of the exposure level indicator will display <◀> or <▶>.

Flash Exposure Compensation ☆

Set flash exposure compensation if the flash exposure of the subject does not come out as desired. You can set the flash exposure compensation up to ± 2 stops in $1/3$ -stop increments.

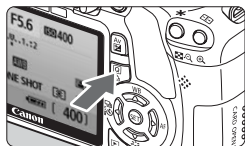

1 Display the Quick Control screen.

- With the shooting settings displayed, press the $\langle \text{Q} \rangle$ button (p.38).
- ▶ The Quick Control screen will activate (10).



2 Select [].

- Press the $\langle \text{◀} \text{◀} \rangle$ key to select [*].
- ▶ [**Flash exposure comp.**] will be displayed at the bottom.



3 Set the flash exposure compensation amount.

- To make the flash exposure brighter, turn the $\langle \text{◀} \text{◀} \rangle$ dial to the right. (Increased exposure)
- Or to make it darker, turn the $\langle \text{◀} \text{◀} \rangle$ dial to the left. (Decreased exposure)

▶ When you press the shutter button halfway, the $\langle \text{◀} \text{◀} \rangle$ will appear in the viewfinder.

- **After taking the picture, do steps 1 to 3 to return the flash exposure compensation amount to zero.**

 If the [$\text{Auto Lighting Optimizer}$] (p.103) is set to anything other than [**Disable**], the image may look bright even if a decreased exposure compensation or flash exposure compensation has been set.

- You can also set and cancel the flash exposure compensation with the [Flash control] menu's [**Built-in flash func. setting**] option. Select [**Flash exp. comp**] (p.149).
- The exposure compensation can also be set with the [Expo. comp./AEB] menu (p.89).

MENU Auto Exposure Bracketing ☆

This feature takes exposure compensation a step further by varying the exposure automatically with three shots (± 2 stops in 1/3-stop increments) as shown below. You can then choose the best exposure. This is called AEB (Auto Exposure Bracketing).



Standard exposure



Darker exposure
(Decreased exposure)



Brighter exposure
(Increased exposure)



1 Select [Expo. comp./AEB].

- Under the [☑] tab, select [Expo. comp./AEB], then press <SET>.

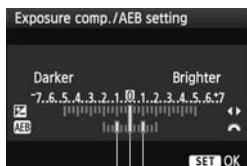

2 Set the AEB amount.

- Turn the <☀> dial to set the AEB amount.
- Press the <◀▶> key to set the exposure compensation amount. If AEB is combined with exposure compensation, AEB will be applied centering on the exposure compensation amount.
- Press <SET> to set it.
- When you press the shutter button halfway, the AEB amount will be displayed on the LCD monitor.

AEB amount



3 Take the picture.

- Focus and press the shutter button completely. The three bracketed shots will be taken in this sequence: Standard exposure, decreased exposure, and increased exposure.

Canceling AEB

- Follow steps 1 and 2 to turn off the AEB amount display.
- The AEB setting will be canceled automatically if the power switch is set to <OFF>, flash recycling is complete, etc.



Shooting Tips

- **Using AEB with continuous shooting.**
If <□> continuous shooting (p.70) has been set and you press the shutter button completely, the three bracketed shots will be taken continuously in this sequence: Standard exposure, decreased exposure, and increased exposure.
- **Using AEB with <□> single shooting.**
Press the shutter button three times to take the three bracketed shots. The three bracketed shots will be exposed in the following sequence: Standard exposure, decreased exposure, and increased exposure.
- **Using AEB with exposure compensation.**
Centering on the exposure compensation amount, AEB will be applied.
- **Using AEB with the self-timer or wireless remote control.**
With the self-timer or wireless remote control (<⏸> or <⏸₂>), you can take three continuous shots. With <⏸₂> set, the number of continuous shots will be three times the number set (p.57).



- Neither flash nor bulb exposures can be used with AEB.
- If the [Auto Lighting Optimizer] (p.103) menu is set to other than [Disable], the AEB's effect might be minimal.

Customizing a Picture Style ☆

You can customize a Picture Style by adjusting individual parameters like **[Sharpness]** and **[Contrast]**. To see the resulting effects, take test shots. To customize **[Monochrome]**, see page 93.

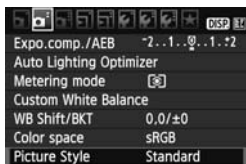

1 Select [Picture Style].

- Under the **[P]** tab, select **[Picture Style]**, then press **<SET>**.
- ▶ The Picture Style selection screen will appear.



2 Select a Picture Style.

- Select a Picture Style, then press the **<DISP.>** button.
- ▶ The Detail set. screen will appear.



3 Select a parameter.

- ▶ Select a parameter such as **[Sharpness]**, then press **<SET>**.



4 Set the parameter.

- Press the **<◀▶>** key to adjust the parameter as desired, then press **<SET>**.
- Press the **<MENU>** button to save the adjusted parameters. The Picture Style selection screen will reappear.
- ▶ Any parameter settings different from the default will be displayed in blue.



Parameter Settings and Effects

Sharpness

Adjusts the sharpness of the image.

To make it less sharp, set it toward the **0** end. The closer it is to **0**, the softer the image will look.

To make it sharper, set it toward the **7** end. The closer it is to **7**, the sharper the image will look.

Contrast

Adjusts the image contrast and the vividness of colors.

To decrease the contrast, set it toward the minus end. The closer it is to **-**, the blander the image will look.

To increase the contrast, set it toward the plus end. The closer it is to **+**, the crisper the image will look.

Saturation

The image's color saturation can be adjusted.

To decrease the color saturation, set it toward the minus end.

The closer it is to **-**, the more diluted the colors will look.

To increase the color saturation, set it toward the plus end. The closer it is to **+**, the bolder the colors will look.

Color tone

The skin tones can be adjusted.

To make the skin tone redder, set it toward the minus end. The closer it is to **-**, the redder the skin tone will look.

To make the skin tone less red, set it toward the plus end. The closer it is to **+**, the more yellow the skin tone will look.



- By selecting [**Default set.**] in step 3, you can revert the respective Picture Style to its default parameter settings.
- The above adjustments will not be applied to the Picture Styles used in the <CA> (Creative Auto) mode.

Monochrome Adjustment

For Monochrome, you can also set **[Filter effect]** and **[Toning effect]** in addition to **[Sharpness]** and **[Contrast]** explained on the preceding page.

Filter Effect



With a filter effect applied to a monochrome image, you can make white clouds or green trees stand out more.

Filter	Sample Effects
N: None	Normal black-and-white image with no filter effects.
Ye: Yellow	The blue sky will look more natural, and the white clouds will look crisper.
Or: Orange	The blue sky will look slightly darker. The sunset will look more brilliant.
R: Red	The blue sky will look quite dark. Fall leaves will look crisper and brighter.
G: Green	Skin tones and lips will look fine. Tree leaves will look crisper and brighter.

Increasing the **[Contrast]** will make the filter effect more pronounced.

Toning Effect

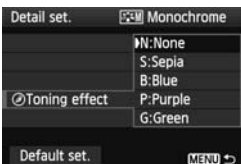

By applying a toning effect, you can create a monochrome image in that color. It can make the image look more impressive.

The following can be selected: **[N:None]** **[S:Sepia]** **[B:Blue]** **[P:Purple]** **[G:Green]**.

🔧 Registering a Picture Style ☆

You can select a base Picture Style such as [Portrait] or [Landscape], adjust its parameters as desired and register it under [User Def. 1], [User Def. 2], or [User Def. 3].

You can create Picture Styles whose parameter settings such as for sharpness and contrast are different. You can also adjust the parameters of a Picture Style which has been registered to the camera with the provided software.

1 Select [Picture Style].

- Under the [P] tab, select [Picture Style], then press <SET>.
- ▶ The Picture Style selection screen will appear.



2 Select [User Def.].

- Select [User Def. *], then press the <DISP.> button.
- ▶ The Detail set. screen will appear.

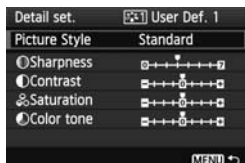

3 Press <SET>.

- With [Picture Style] selected, press <SET>.

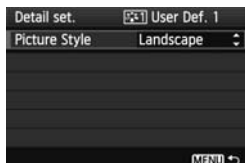

4 Select the base Picture Style.

- Press the <▲▼> key to select the base Picture Style, then press <SET>.
- To adjust the parameters of a Picture Style which has been registered to the camera with the provided software, select the Picture Style here.



5 Select a parameter.

- Select a parameter such as **[Sharpness]**, then press **<SET>**.

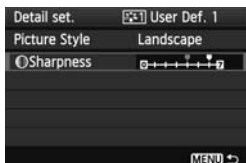

6 Set the parameter.

- Press the **<◀▶>** key to adjust the parameter as desired, then press **<SET>**.

For details, see “Customizing a Picture Style” on pages 91-93.

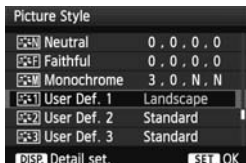

- Press the **<MENU>** button to register the new Picture Style. The Picture Style selection screen will then reappear.
 - ▶ The base Picture Style will be indicated on the right of **[User Def. *]**.
 - ▶ The name of the Picture Style having any modified settings (different from the default) registered under **[User Def. *]** will be displayed in blue.



- If a Picture Style has already been registered under **[User Def. *]**, changing the base Picture Style in step 4 will nullify the parameter settings of the registered Picture Style.
- If you execute **[Clear all camera settings]** (p.144), all the **[User Def. *]** settings will revert to the default.



To shoot with the registered Picture Style, follow step 2 on page 75 to select **[User Def. *]** and then shoot.

MENU Setting the Color Space [☆]

The color space refers to the range of reproducible colors. With this camera, you can set the color space to sRGB or Adobe RGB for captured images. For normal shooting, sRGB is recommended. In Basic Zone modes, sRGB is set automatically.

1 Select [Color space].

- Under the [] tab, select [Color space], then press < (SET) >.

2 Set the desired color space.

- Select [sRGB] or [Adobe RGB], then press < (SET) >.

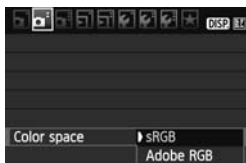

About Adobe RGB

This color space is mainly used for commercial printing and other industrial uses. This setting is not recommended if you do not know about image processing, Adobe RGB, and Design rule for Camera File System 2.0 (Exif 2.21).

The image will look very subdued in a sRGB personal computer environment and with printers not compatible with Design rule for Camera File System 2.0 (Exif 2.21). Post-processing of the image with software will therefore be required.



- If the image is captured with the color space set to Adobe RGB, the file name will start with “_MG_” (first character is an underscore).
- The ICC profile is not appended. See explanations about the ICC profile in the Software Instruction Manual in the CD-ROM.

✳ AE Lock ☆

Use AE lock when the area of focus is to be different from the exposure metering area or when you want to take multiple shots at the same exposure setting. Press the <✳> button to lock the exposure, then recompose and take the shot. This is called AE lock. It is effective for backlit subjects.

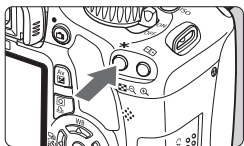

1 Focus the subject.

- Press the shutter button halfway.
- ▶ The exposure setting will be displayed.

2 Press the <✳> button. (☉4)

- ▶ The <✳> icon lights in the viewfinder to indicate that the exposure setting is locked (AE lock).
- Each time you press the <✳> button, it locks the current auto exposure setting.





3 Recompose and take the picture.

- If you want to maintain the AE lock while taking more shots, hold down the <✳> button and press the shutter button to take another shot.



AE Lock Effects

Metering Mode (p.86)	AF Point Selection Method (p.68)	
	Automatic Selection	Manual Selection
	AE lock is applied at the AF point that achieved focus.	AE lock is applied at the selected AF point.
	AE lock is applied at the center AF point.	

* When the lens' focus mode switch is set to <MF>, AE lock is applied at the center AF point.

✳ FE Lock ☆

FE lock locks the flash exposure setting over the desired area of the subject. This feature can also be used with a Canon EX-series Speedlite.

* FE stands for Flash Exposure.

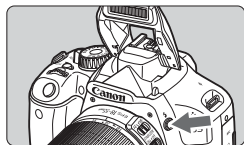

1 Press the <⚡> button to pop-up the built-in flash.

- Press the shutter button halfway and look in the viewfinder to check that the <⚡> icon is lit.



2 Focus the subject.

Spot metering circle

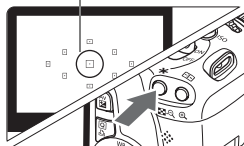

3 Press the <✳> button. (Ⓜ16)

- Aim the spot-metering circle over the subject, then press the <✳> button.
- ▶ The flash will fire a preflash and the required flash output is calculated and retained in memory.
- ▶ In the viewfinder, “FEL” is displayed for a moment and <⚡✳> will light.
- Each time you press the <✳> button, a preflash is fired and the required flash output is calculated and retained in memory.



4 Take the picture.

- Compose the shot and press the shutter button completely.
- ▶ The flash is fired to take the picture.



⚠ If the subject is too far away and beyond the effective range of the flash, the <⚡> icon will blink. Get closer to the subject and repeat steps 2 to 4.

WB: Setting the White Balance ☆

White balance (WB) is for making the white areas look white. Normally, the <AWB> (Auto) setting will obtain the correct white balance. If natural-looking colors cannot be obtained with <AWB>, you can select the white balance to match the light source or set it manually by shooting a white object. In Basic Zone modes, <AWB> will be set automatically.

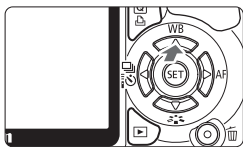

1 Press the <▲ WB> button.

- ▶ [White balance] will appear.

2 Select the white balance.

- Press the <◀▶> key to select the desired white balance, then press <SET>.
- The “Approx. ****K” (K: Kelvin) displayed for the selected white balance <☀> <🏠> <☁> <☀> <🌧> is the respective color temperature.

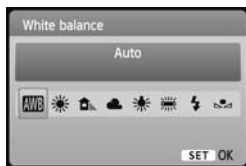

📷 Custom White Balance

Custom white balance enables you to manually set the white balance for a specific light source for better accuracy. Do this procedure under the actual light source to be used.

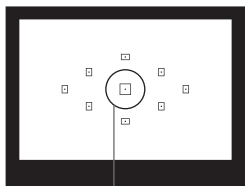

1 Photograph a white object.

- The plain, white object should fill the spot metering circle.
- Focus manually and set the standard exposure for the white object.
- You can set any white balance.

Spot metering circle

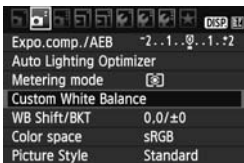

2 Select [Custom White Balance].

- Under the [C] tab, select [Custom White Balance], then press <SET>.
- ▶ The custom white balance selection screen will appear.



3 Import the white balance data.

- Select the image that was captured in step 1, then press <SET>.
- ▶ On the dialog screen which appears, select [OK] and the data will be imported.
- When the menu reappears, press the <MENU> button to exit the menu.

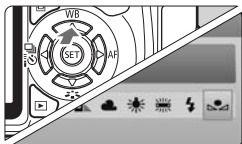

4 Select the custom white balance.

- Press the <▲ WB> button.
- Press the <◀▶> key to select <[WB]>, then press <SET>.

- If the exposure obtained in step 1 is way off, a correct white balance might not be obtained.
- If the image was captured while the Picture Style was set to [Monochrome] (p.76), it cannot be selected in step 3.

- Instead of a white object, an 18% gray card (commercially available) can produce a more accurate white balance.
- The personal white balance registered with the provided software will be registered under <[WB]>. If you do step 3, the data for the registered personal white balance will be erased.

WB \pm White Balance Correction ☆

You can correct the white balance that has been set. This adjustment will have the same effect as using a commercially-available color temperature conversion filter or color compensating filter. Each color can be corrected to one of nine levels.

This is for advanced users who are familiar with using color temperature conversion or color compensating filters.

White Balance Correction

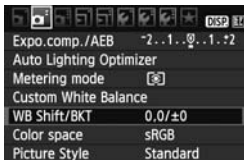

1 Select [WB Shift/BKT].

- Under the [\square] tab, select [WB Shift/BKT], then press <SET>.
- ▶ The WB correction/WB bracketing screen will appear.

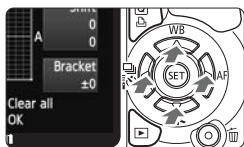

2 Set the white balance correction.

- Press the <◇> key to move the “■” mark to the desired position.
- B is for blue, A is amber, M is magenta, and G is green. The color in the respective direction will be corrected.
- On the upper right, “Shift” indicates the direction and correction amount.
- Pressing the <DISP.> button will cancel all the [WB Shift/BKT] settings.
- Press <SET> to exit the setting and return to the menu.

Sample setting: A2, G1

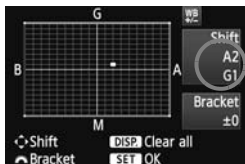

- During the white balance correction, <WB \pm > will be displayed in the viewfinder and on the LCD monitor.
- One level of the blue/amber correction is equivalent to 5 mireds of a color temperature conversion filter. (Mired: Measuring unit indicating the density of a color temperature conversion filter.)

White Balance Auto Bracketing

With just one shot, three images having a different color balance can be recorded simultaneously. Based on the color temperature of the current white balance setting, the image will be bracketed with a blue/amber bias or magenta/green bias. This is called white balance bracketing (WB-BKT). White balance bracketing is possible up to ± 3 levels in single-level increments.

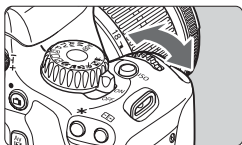

B/A bias ± 3 levels

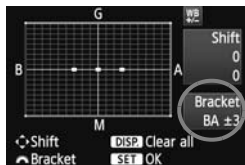

Set the white balance bracketing amount.

- In step 2 for white balance correction, when you turn the  dial, the "■" mark on the screen will change to "■■■" (3 points). Turning the dial to the right sets the B/A bracketing, and turning it to the left sets the M/G bracketing.
- ▶ On the right, "**Bracket**" indicates the bracketing direction and correction amount.
- Pressing the <DISP.> button will cancel all the [WB Shift/BKT] settings.
- Press <SET> to exit the setting and return to the menu.

Bracketing Sequence

The images will be bracketed in the following sequence: 1. Standard white balance, 2. Blue (B) bias, and 3. Amber (A) bias, or 1. Standard white balance, 2. Magenta (M) bias, and 3. Green (G) bias.

 During WB bracketing, the maximum burst for continuous shooting will be lower and the number of possible shots will also decrease to one-third the normal number.

- Since three images are recorded for one shot, the card will take longer to record the shot.
- "**BKT**" stands for Bracketing.

MENU Auto Lighting Optimizer ☆

If the image comes out dark or the contrast is low, the brightness and contrast can be corrected automatically. With JPEG images, the correction is done when the image is captured. For RAW images, it can be corrected with Digital Photo Professional (provided software). The default setting is [Standard].

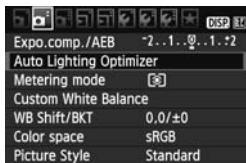

1 Select [Auto Lighting Optimizer].

- Under the [MENU] tab, select [Auto Lighting Optimizer], then press <SET>.



2 Set the correction setting.

- Press the <◀▶> key to select the desired setting, then press <SET>.

3 Take the picture.

- The image will be recorded with the brightness and contrast corrected if necessary.



Sample of corrected brightness



- Depending on the shooting conditions, noise might increase.
- If a setting other than [Disable] is set and you use exposure compensation, flash exposure compensation, or manual exposure to darken the exposure, the image might still come out bright. If you want a darker exposure, set this to [Disable] first.



In Basic Zone modes, [Standard] is set automatically.

MENU Lens Peripheral Illumination Correction

Due to the lens characteristics, the four corners of the picture might look darker. This is called lens light fall-off or drop in peripheral illumination. With JPEG images, the correction is done when the image is captured. For RAW images, it can be corrected with Digital Photo Professional (provided software).

The default setting is **[Enable]**.

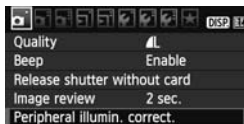

1 Select **[Peripheral illumin. correct.]**.

- Under the [] tab, select **[Peripheral illumin. correct.]**, then press <SET>.

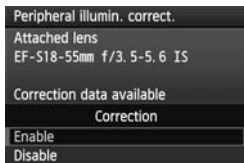

2 Set the correction setting.

- On the screen, check that the attached lens' **[Correction data available]** is displayed.
- If **[Correction data not available]** is displayed, see "About the Lens Correction Data" on the next page.
- Press the <▲▼> key to select **[Enable]**, then press <SET>.

3 Take the picture.

- The image will be recorded with the corrected peripheral illumination.



Correction enabled



Correction disabled

About the Lens Correction Data

The camera already contains lens peripheral illumination correction data for approx. 25 lenses. In step 2, if you select **[Enable]**, the peripheral light correction will be applied automatically for any lens whose correction data has been registered in the camera.

With EOS Utility (provided software), you can check which lenses have their correction data registered in the camera. You can also register the correction data for unregistered lenses. For details, see the Software Instruction Manual (CD-ROM) for EOS Utility.



- For JPEG images already captured, lens peripheral illumination correction cannot be applied.
- Depending on shooting conditions, noise might appear on the image periphery.
- When using a non-Canon lens, setting the correction to **[Disable]** is recommended, even if **[Correction data available]** is displayed.



- Lens peripheral light correction is applied even when an Extender is attached.
- If the correction data for the attached lens has not been registered to the camera, the result will be the same as when the correction is set to **[Disable]**.
- The correction amount applied will be slightly lower than the maximum correction amount settable with Digital Photo Professional (provided software).
- If the lens does not have distance information, the correction amount will be lower.
- The higher the ISO speed, the lower the correction amount will be.

Preventing Camera Shake [☆]

The camera's mechanical shake caused by the reflex mirror action can blur images taken with a super telephoto lens or close-up (macro) lens. In such cases, mirror lockup is effective.

Mirror lockup is enabled by selecting the [F: Custom Functions (C.Fn)] menu's [Mirror lockup] and setting it to [1: Enable] (p.195).

1 Focus the subject, press the shutter button completely.

- ▶ The mirror will swing up.

2 Press the shutter button completely again.

- ▶ The picture is taken and the mirror goes back down.



Shooting Tips

● Using the self-timer <S2> with mirror lockup.

When you press the shutter button completely, the mirror locks up, then the picture is taken 2 sec. later.

● Remote control shooting.

Since you do not touch the camera when the picture is taken, remote control shooting together with mirror lockup can further prevent camera shake. With Remote Controller RC-6 set to a 2-sec. delay, press the transmit button, the mirror will lockup and the picture will be taken 2 sec. later.



- Do not point the camera toward the sun. The sun's heat can damage the camera's internal components.
- If you use the self-timer and mirror lockup in combination with a bulb exposure, keep pressing the shutter button completely (self-timer delay time + bulb exposure time). If you let go of the shutter button during the self-timer countdown, there will be a shutter-release sound, but no picture will be taken.



- Even if <C> (Continuous shooting) has been set, single shooting will take effect.
- If 30 seconds elapse after the mirror has locked up, it will go back down automatically. Pressing the shutter button completely again locks up the mirror again.

5

Shooting with the LCD Monitor (Live View Shooting)

You can shoot while viewing the image on the camera's LCD monitor. This is called "Live View shooting."

Live View shooting is effective for still subjects which do not move.

If you handhold the camera and shoot while viewing the LCD monitor, camera shake can cause blurred images. Using a tripod is recommended.



About Remote Live View Shooting

With EOS Utility (provided software) installed in your computer, you can connect the camera to the computer and shoot remotely while viewing the computer screen. For details, see the Software Instruction Manual in the CD-ROM.

Shooting with the LCD Monitor



1 Display the Live View image.

- Press the  button.
- ▶ The Live View image will appear on the LCD monitor.
- The Live View image will closely reflect the brightness level of the actual image you capture.
- The image's field of view is approx. 100%.



2 Focus the subject.

- Before shooting, focus with AF or manual focus (p.113-120).
- When you press the shutter button halfway, the camera will focus with the current AF mode.

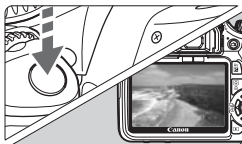

3 Take the picture.

- Press the shutter button completely.
- ▶ The picture will be taken and the captured image is displayed on the LCD monitor.
- ▶ After the image review ends, the camera will return to Live View shooting automatically.
- Press the  button to end the Live View shooting.

To Enable Live View Shooting

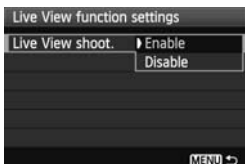

Under [**Live View function settings**], set [**Live View shoot.**] to [**Enable**].

Battery Life with Live View Shooting [Approx. number of shots]

Temperature	Shooting Conditions	
	No Flash	50% Flash Use
At 23°C / 73°F	200	180
At 0°C / 32°F	170	150

- The figures above are based on a fully-charged Battery Pack LP-E8 and CIPA (Camera & Imaging Products Association) testing standards.
- Continuous Live View shooting is possible for approx. 1 hr. 30 min. at 23°C/ 73°F (with a fully-charged Battery Pack LP-E8).



- During Live View shooting, do not point the lens toward the sun. The sun's heat can damage the camera's internal components.
- **Cautions for using Live View shooting are on pages 121-122.**



When flash is used, there will be two shutter sounds, but only one shot will be taken.

About the Information Display

- Each time you press the <DISP.> button, the information display will change.

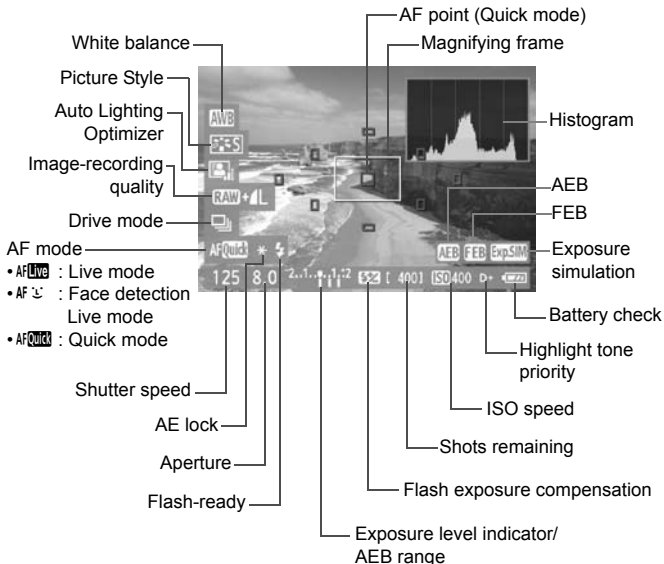

- When <Exp.SIM> is displayed in white, it indicates that the Live View image brightness is close to what the captured image will look like.
- If <Exp.SIM> is blinking, it indicates that the Live View image is not being displayed at the suitable brightness due to low or bright light conditions. However, the actual image recorded will reflect the exposure setting.
- If flash is used or bulb is set, the <Exp.SIM> icon and histogram will be grayed out (for your reference). The histogram might not be properly displayed in low- or bright-light conditions.

Shooting Function Settings

Function settings particular to Live View shooting are explained here.

Quick Control

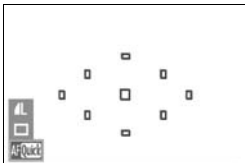

While the image is displayed on the LCD monitor, pressing the  button will enable you to set the image-recording quality, drive mode, and AF mode. In Creative Zone modes, you can also set the white balance, Picture Style, and Auto Lighting Optimizer.



1 Press the button.

- ▶ The settable functions will be highlighted in blue.
- When  is selected, the AF points will also be displayed.

2 Select a function and set it.

- Press the  key to select the function to be set.
- ▶ The setting of the selected function is displayed at the bottom.
- Turn the  dial to change the setting.

MENU Menu Function Settings

Live View function settings	
Live View shoot.	Enable
Grid display	Off
Metering timer	16 sec.
AF mode	Live mode
MENU →	

The menu options under the [] tab's [Live View function settings] menu are explained below.

The functions settable in this menu screen only apply during Live View shooting. These functions do not take effect during viewfinder shooting.

- **Grid display**

With [Grid 1 ] or [Grid 2 ], you can display grid lines.







- **Metering timer**

You can change how long the exposure setting is displayed (AE lock time).

- **AF mode**

You can select [Live mode] (p.113), [ Live mode] (p.114), or [Quick mode] (p.118).



- Even while the Live View image is displayed, you can still set <MENU> functions and execute playback <▶>. If you select [ Dust Delete Data], [ Sensor cleaning], [ Clear settings], or [ Firmware Ver.], the Live View shooting will be terminated.
- The metering mode will be fixed to evaluative metering for Live View shooting.
- In Creative Zone modes, you can check the depth of field by pressing the depth-of-field preview button.
- During continuous shooting, the exposure set for the first shot will also be applied to subsequent shots.
- Using <A-DEP> will be the same as using <P>.
- If the camera is not operated for a prolonged period, the power will turn off automatically as set with [ Auto power off] (p.139). If [ Auto power off] is set to [Off], the Live View shooting will stop automatically after 30 min. (camera power remains on).
- With the AV cable (provided) or HDMI cable (sold separately), you can display the Live View image on a TV (p.167, 169).
- You can also use a remote controller (sold separately, p.204) for Live View shooting.

Using AF to Focus

Selecting the AF Mode

The AF modes available are [**Live mode**], [**Live mode**] (face detection, p.114), and [**Quick mode**] (p.118).

If you want to achieve precise focus, set the lens focus mode switch to <MF>, magnify the image, and focus manually (p.120).

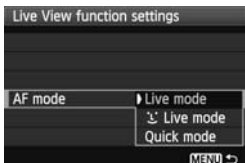

Select the AF mode.

- Under [**Live View function settings**], select [**AF mode**].
- While the Live View image is displayed, you can press the <Q> button to select the AF mode on the Quick Control screen.

Live Mode: AF Live

The image sensor is used to focus. Although AF is possible with the Live View image displayed, **the AF operation will take longer than with the Quick mode**. Also, achieving focus may be more difficult than with the Quick mode.



AF point

1 Display the Live View image.

- Press the <Q> button.
- ▶ The Live View image will appear on the LCD monitor.
- ▶ The AF point <□> will appear.

2 Move the AF point.

- Press the <D> key to move the AF point to where you want to focus (it cannot go to the edges of the picture).
- To return the AF point to the center, press the <Q> button.

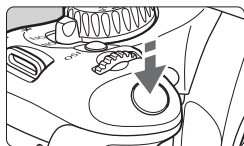

3 Focus the subject.

- Aim the AF point over the subject and press the shutter button halfway.
- ▶ When focus is achieved, the AF point will turn green and the beeper will sound.
- ▶ If focus is not achieved, the AF point will turn orange.



4 Take the picture.

- Check the focus and exposure, then press the shutter button completely to take the picture (p.108).

☺ (Face detection) Live Mode: AF ☺

With the same AF method as the Live mode, human faces are detected and focused. Have the target person face the camera.



1 Display the Live View image.

- Press the <📷> button.
- ▶ The Live View image will appear on the LCD monitor.
- When a face is detected, the <☺> frame will appear over the face to be focused.
- If multiple faces are detected, <☺☺> will be displayed. Press the <◀▶> key to move the <☺> frame over the target face.

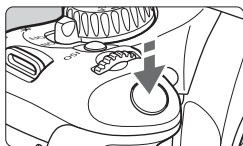

2 Focus the subject.

- Press the shutter button halfway and the camera will focus the face covered by the <[]> frame.
- ▶ When focus is achieved, the AF point will turn green and the beeper will sound.
- ▶ If focus is not achieved, the AF point will turn orange.
- If a face cannot be detected, the AF point <[]> will be displayed and AF will be executed at the center.



3 Take the picture.

- Check the focus and exposure, then press the shutter button completely to take the picture (p.108).





- If the focus is way off, face detection will not be possible. If the lens enables manual focusing even while the lens focus mode switch is set to <AF>, turn the focusing ring to attain rough focus. The face will then be detected and <[]> will be displayed.
- An object other than a human face might be detected as a face.
- Face detection will not work if the face is very small or large in the picture, too bright or too dark, tilted horizontally or diagonally, or partially hidden.
- The <[]> focusing frame might cover only part of the face.



- When you press the <[]> button, the AF mode will switch to the Live mode (p.113). You can press the <[]> key to move the AF point. Press the <[]> button again to return to the <[]> (face detection) Live mode.
- Since AF is not possible with a face detected near the edge of the picture, the <[]> will be grayed out. Then if you press the shutter button halfway, the center AF point <[]> will be used to focus.

Live Mode and (Face Detection) Live Mode Notes

AF operation

- Focusing will take slightly longer.
- Even when focus has been achieved, pressing the shutter button halfway will focus again.
- The image brightness may change during and after the AF operation.
- If the light source changes while the Live View image is displayed, the screen might flicker and focusing can be difficult. If this happens, stop the Live View shooting and autofocus under the actual light source first.
- If you press the  button in the Live mode, the image will be magnified at the AF point. If focusing is difficult in the magnified view, return to the normal view and autofocus. Note that the AF speed may differ between the normal and magnified views.
- If you autofocus in the Live mode's normal view and then magnify the image, the focus might be off.
- In the  Live mode, pressing the  button will not magnify the image.



- In the Live mode or  (face detection) Live mode, if you shoot a peripheral subject and the target subject is slightly out of focus, aim the center AF point over the subject to focus, then take the picture.
- The AF-assist beam will not be emitted.

Shooting conditions which can make focusing difficult:

- Low-contrast subjects such as the blue sky and solid-color, flat surfaces.
- Subjects in low light.
- Stripes and other patterns where there is contrast only in the horizontal direction.
- Under a light source whose brightness, color, or pattern keeps changing.
- Night scenes or points of light.
- Under fluorescent lighting or when the image flickers.
- Extremely small subjects.
- Subjects at the edge of the picture.
- Subjects strongly reflecting light.
- The AF point covers both a near and faraway subject (such as an animal in a cage).
- Subjects which keep moving within the AF point and cannot keep still due to camera shake or subject blur.
- A subject approaching or moving away from the camera.
- Autofocusing while the subject is way out of focus.
- Soft focus effect is applied with a soft focus lens.
- A special effects filter is used.

Quick Mode: AFQuick

The dedicated AF sensor is used to focus in the One-Shot AF mode (p.66), using the same AF method as with viewfinder shooting. Although you can focus the target area quickly, **the Live View image will be interrupted momentarily during the AF operation.**

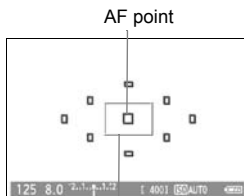



Magnifying frame

1 Display the Live View image.

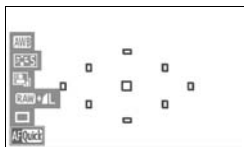
- Press the <  > button.
- ▶ The Live View image will appear on the LCD monitor.
- The small boxes on the screen are the AF points, and the larger box is the magnifying frame.

**2 Select the AF point.** ☆

- When you press the <  > button, the Quick Control screen will appear.
- ▶ The settable functions will be highlighted in blue.
- Press the <  > key to make the AF point selectable.
- Turn the <  > dial to select the AF point.

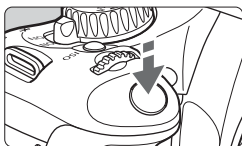

3 Focus the subject.

- Aim the AF point over the subject and press the shutter button halfway.
- ▶ The Live View image will turn off, the reflex mirror will go back down, and AF will be executed.
- ▶ When focus is achieved, the beeper will sound and the Live View image will reappear.
- ▶ The AF point used to focus will light in red.



4 Take the picture.

- Check the focus and exposure, then press the shutter button completely to take the picture (p.108).



You cannot take a picture during autofocusing. Take the picture only while the Live View image is displayed.

Focusing Manually

You can magnify the image and focus precisely manually.

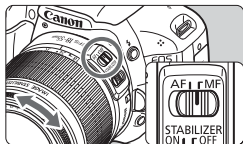

1 Set the lens focus mode switch to <MF>.

- Turn the lens focusing ring to focus roughly.

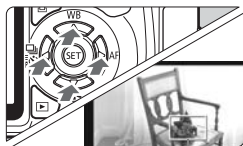

2 Move the magnifying frame.

- Press the <AF-ON> key to move the magnifying frame to the position where you want to focus.
- To return the magnifying frame to the center, press the <AF-ON> button.

Magnifying frame

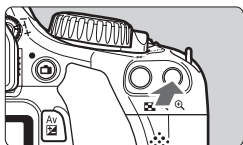

3 Magnify the image.

- Press the <5x/10x> button.
- ▶ The part within the magnifying frame will be magnified.
- Each time you press the <5x/10x> button, the view will change as follows:

→ 5x → 10x → Normal view



4 Focus manually.

- While looking at the magnified image, turn the lens focusing ring to focus.
- After achieving focus, press the <5x/10x> button to return to the normal view.

AE lock
Magnified area position
Magnification

5 Take the picture.

- Check the focus and exposure, then press the shutter button to take the picture (p.108).



Notes About the Live View Image

- Under low or bright light conditions, the Live View image might not reflect the brightness of the captured image.
- If the light source within the image changes, the screen might flicker. If this happens, stop and resume the Live View shooting under the actual light source to be used.
- If you point the camera in a different direction, it might throw off the Live View image's correct brightness momentarily. Wait until the brightness level stabilizes before shooting.
- If there is a very bright light source in the picture, such as the sun, the bright area might appear black on the LCD monitor. However, the actual captured image will correctly show the bright area.
- In low light, if you set the [**⚡**: **LCD brightness**] to a bright setting, chrominance noise may appear in the Live View image. However, the chrominance noise will not be recorded in the captured image.
- When you magnify the image, the image sharpness may look more pronounced than it really is.

About the <🌡️> icon and camera's internal temperature increase

- When you shoot continuously with the Live View function for a long period or in high temperatures, the camera's internal temperature may increase and the <🌡️> warning icon will appear on the screen. Note that if you shoot with the Live View function for a long period in high temperatures, the <🌡️> warning icon will appear earlier. Turn off the camera when not shooting images.
- If you shoot with the Live View function while the <🌡️> warning icon is displayed, the image quality of still photos may be degraded. You should stop Live View shooting and allow the camera to rest until the camera's internal temperature decreases.
- If Live View shooting continues while the <🌡️> warning icon is displayed, the camera's internal temperature will further increase and Live View shooting may stop automatically. Live View shooting will be disabled until the camera's internal temperature decreases. Turn off the camera and allow the camera to rest for a while.

Notes About the Shooting Results

- When you shoot continuously with the Live View function for a long period, the camera's internal temperature may increase and it can degrade image quality. Terminate Live View shooting when not shooting images.
- Before taking a long exposure, stop Live View shooting temporarily and wait several minutes before shooting. This is to prevent image degradation.
- Live View shooting in high temperatures and at high ISO speeds may cause noise or irregular colors.
- When you shoot at high ISO speeds, noise (banding, dots of light, etc.) may appear.
- If you take the picture during magnified view, the exposure might not come out as desired. Return to the normal view before taking the picture. During the magnified view, the shutter speed and aperture will be displayed in red. Even if you take the picture during magnified view, the image will be captured in the normal view.
- If the [ Auto Lighting Optimizer] (p.103) menu is set to anything other than [**Disable**], the image may look bright even if a decreased exposure compensation or flash exposure compensation has been set.

Custom Function Notes

- During Live View shooting, certain Custom Function settings will be disabled (p.191).

Notes About Lenses and Flash

- The focus preset feature on super telephoto lenses cannot be used.
- FE lock is not possible when the built-in flash or an external Speedlite is used. Modeling flash and test flash will not fire if an external Speedlite is used.

6

Shooting Movies

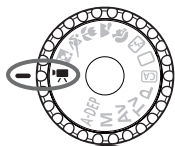

Set the Mode Dial to <[Movie Camera Icon]> to shoot movies. The movie recording format will be MOV.

Cards which can record movies

When shooting movies, use a large-capacity SD card rated SD Speed Class 6 “CLASS 6” or higher.

If you use a slow-writing card when shooting movies, the movie might not be recorded properly. And if you playback a movie on a card having a slow reading speed, the movie might not playback properly.

To check the card's read/write speed, refer to the card manufacturer's Web site.

About Full HD 1080

Full HD 1080 indicates compatibility with High-Definition featuring 1080 vertical pixels (scanning lines).



Shooting Movies

Connecting the camera to a TV set is recommended to playback movies (p.167, 169).

Autoexposure Shooting

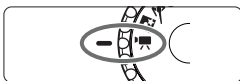

1 Set the Mode Dial to <Movie>.

- ▶ The reflex mirror will make a sound, then the image will appear on the LCD monitor.

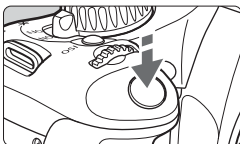

2 Focus the subject.

- Before shooting a movie, autofocus or manual focus (p.113-120).
- When you press the shutter button halfway, the camera will focus with the current AF mode.







3 Shooting the movie.

- Press the <Movie> button to start shooting a movie. To stop movie shooting, press <Movie> again.
- ▶ While the movie is being shot, the “●” mark will be displayed on the upper right of the screen.

- During movie shooting, do not point the lens toward the sun. The sun's heat can damage the camera's internal components.
- **Cautions for movie shooting are on pages 135 and 136.**
- **If necessary, also read the Live View shooting cautions on pages 121 and 122.**



- One continuous movie will be recorded as one file.
- During movie shooting, the top, bottom, left, and right parts of the screen will have a semi-transparent mask. The area enclosed by the semi-transparent mask will be the movie image that is recorded. The semi-transparent mask size will change depending on the [ **Movie rec. size**] setting (p.131). If you use Movie crop, the unrecorded image areas will be displayed in black mask.
- AE lock is possible by pressing the < > button (p.97). To cancel AE lock during movie shooting, press the < > button.
- The ISO speed, shutter speed, and aperture are set automatically.
- By holding down the < > button and turning the < > dial, you can set the exposure compensation.
- Pressing the shutter button halfway displays the shutter speed and aperture (p.126) on the screen's bottom left. This is the exposure setting for taking a still photo.
- Monaural sound is recorded by the camera's built-in microphone (p.16).
- Stereo sound recording is possible by connecting an external microphone equipped with a stereo mini plug (3.5mm dia.) to the camera's external microphone IN terminal (p.16).
- The sound recording level will be adjusted automatically.
- With a fully-charged Battery Pack LP-E8, the total shooting time will be as follows: At 23°C/73°F: Approx. 1 hr. 40 min., At 0°C/32°F: Approx. 1 hr. 20 min.

About the Information Display

- Each time you press the <DISP.> button, the information display will change.

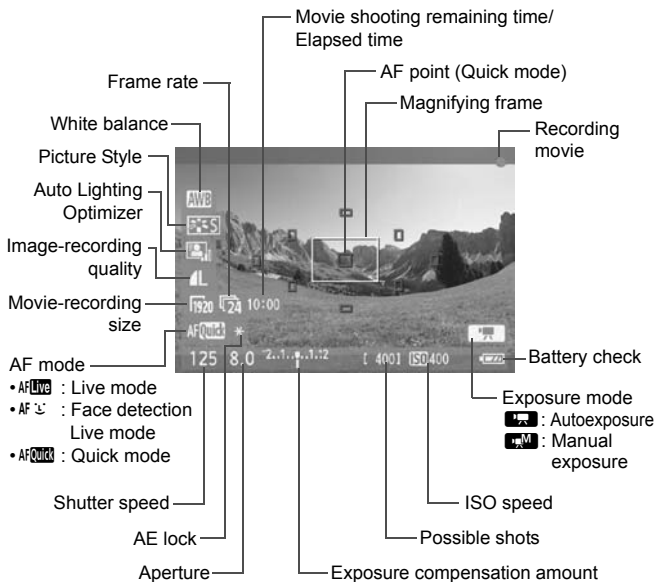

- If there is no card in the camera, the movie shooting remaining time will be displayed in red.
- When movie shooting starts, the movie shooting remaining time will change to the elapsed time.

Manual Exposure Shooting

You can manually set the shutter speed, aperture, and ISO speed for movie shooting. Using manual exposure to shoot movies is for advanced users.



1 Set the Mode Dial to <Movie>.

- ▶ The reflex mirror will make a sound, then the image will appear on the LCD monitor.



2 Select [Movie exposure].

- Under the [Movie] tab, select [Movie exposure], then press <SET>.



3 Select [Manual].

- Select [Manual], then press <SET>.



4 Set the shutter speed and aperture.

- To set the shutter speed, turn the <Shutter Speed> dial. The settable shutter speeds depend on the frame rate <FRM>.
- To set the aperture, hold down the <Av/Σ> button and turn the <Aperture> dial.



5 Set the ISO speed.

- Press the <ISO> button and use either <Shutter Speed> or <Left/Right Arrow> key to select the ISO speed.
- Auto ISO setting: ISO 100 - 6400
- Manual ISO setting: ISO 100 - 6400

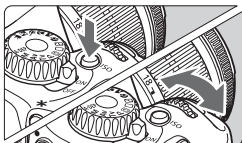

6 Focus and shoot the movie.

- The procedure is the same as steps 2 and 3 for “Autoexposure Shooting” (p.124).

- With manual exposure shooting, AE lock and exposure compensation cannot be set.
- Changing the shutter speed or aperture during movie shooting is not recommended since variations in the exposure will be recorded.
- If you use a lens whose aperture changes while you zoom, you should not zoom while shooting a movie. Zooming while shooting a movie may record changes in the exposure.
- If you shoot a movie under fluorescent lighting, the movie image might flicker.

- With Auto ISO, the correct movie exposure will usually be obtained even if the light level changes.
- When shooting a movie of a moving subject, a shutter speed of 1/30 sec. to 1/125 sec. is recommended. The faster the shutter speed, the less smooth the subject’s movement will look.
- If you playback the movie with “Shooting information display” (p.173), the shooting mode, shutter speed, and aperture will not be displayed. The image information (Exif) will record the settings used at the start of the movie shooting.

Shooting Still Photos

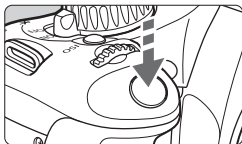

While shooting a movie, you can also take a still photo by pressing the shutter button completely.

Taking still photos during movie shooting

- The still photo will record the entire screen including the semi-transparent mask.
- If you take a still photo during movie shooting, the movie will have a still moment lasting approx. 1 sec.
- The captured still photo will be recorded to the card, and the movie shooting will resume automatically when the Live View image is displayed.
- The card will record the movie and still photo as separate files.
- Functions particular to still shooting are shown below. Other functions will be the same as for movie shooting.

Function	Settings
Image-recording quality	As set in the [Q] Quality menu.
Exposure setting	Shutter speed and aperture set automatically (or set manually for manual exposures). Displayed when the shutter button is pressed halfway.
AEB	Canceled
Drive mode	Single shooting (Self-timer not possible)
Flash	Flash off

Shooting Function Settings

Function settings particular to movie shooting are explained here.

Q Quick Control

While the image is displayed on the LCD monitor, pressing the **<Q>** button will enable you to set the white balance, Picture Style, Auto Lighting Optimizer, image-recording quality (for still photos), movie-recording size, and AF mode.

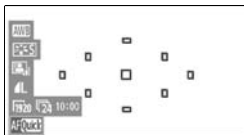

1 Press the **<Q>** button.

- ▶ The settable functions will be highlighted in blue.
- When **<AF Quick>** is selected, the AF points will also be displayed.

2 Select a function and set it.

- Press the **<⬅➡>** key to select the function to be set.
- ▶ The name of the selected function is displayed at the bottom.
- Turn the **<⚙>** dial to change the setting.

 The image-recording quality setting will be reflected in all shooting modes.

MENU Menu Function Settings





Display the movie menu.

- The menu options under the **[M]** and **[M:]** tabs are explained below.

[] Menu

● **Movie-recording size**

You can select the movie's image size [****x****] and frame rate [] (frames recorded per second). The  (frame rate) displayed on the [**Movie rec. size**] screen switches automatically depending on the [ **Video system**] setting.

• **Image size**



[**1920x1080**] : Full HD (Full High-Definition) recording quality.



[**1280x720**] : HD (High-Definition) recording quality.

[**640x480**] : Standard-definition recording quality. The aspect ratio will be 4:3.

[**Crop 640x480**] : Standard-definition recording quality. The aspect ratio will be 4:3. It will give a telephoto effect of about 7x. This shooting mode is called Movie crop.

• **Frame rate** (fps: frames per second)

[] [] : For areas where the TV format is NTSC (North America, Japan, Korea, Mexico, etc.).







[] [] : For areas where the TV format is PAL (Europe, Russia, China, Australia, etc.).

[] : Mainly for motion pictures.

Notes for Movie crop

- Use a tripod to prevent hand-held camera shake.
- The Movie crop image cannot be magnified for focusing.
- Even if the AF mode has been set to [**Quick mode**], it will switch automatically to [**Live mode**] during movie shooting. Also, in [**Live mode**], the AF point is displayed larger than with other recording sizes.
- Noise and dots of light may be more noticeable than in other recording sizes.
- Focusing may be difficult if the AF point covers both a near and far subject.
- Still photos cannot be taken.

Total Movie Recording Time and File Size Per Minute

Movie-recording Size	Total Recording Time		File Size	
	4GB Card	16GB Card		
[1920x1080]		12 min.	49 min.	330 MB/min.
				
				
[1280x720]		12 min.	49 min.	330 MB/min.
				
[640x480] [Crop 640x480]		24 min.	1 hr. 39 min.	165 MB/min.
				

- After you start shooting a movie, the movie shooting will stop automatically if the file size reaches 4 GB or if the movie length reaches 29 min. 59 sec. To start movie shooting again, press the  button. (A new movie file starts being recorded.)
- The semi-transparent or black mask on the top and bottom or on the left and right will not be recorded.
- With ZoomBrowser EX/ImageBrowser (provided software), you can extract a still image from the movie. The still image quality will be as follows: Approx. 2 megapixels at [1920x1080], approx. 1 megapixel at [1280x720], and approx. 300,000 pixels at [640x480].

● **AF mode**

The AF modes will be the same as described on pages 113-119. You can select [**Live mode**], [ **Live mode**], or [**Quick mode**]. Note that continuous focusing of a moving subject is not possible.

● **AF during **

When [**Enable**] is set, AF is possible during movie shooting.

However, continuous autofocus is not possible. If you autofocus during movie shooting, you might momentarily throw the focus way off or change the exposure.

If the AF mode is [**Quick mode**], AF will be executed in Live mode.

- **Shutter/AE lock button**

You can change the function assigned to the AE lock button and to when you press the shutter button halfway.

- **AF/AE lock:**

Normal function. Press the shutter button halfway to execute AF. Press the <★> button for AE lock.

- **AE lock/AF:**

Press the shutter button halfway for AE lock. For AF, press the <★> button. Convenient when you want to focus and meter at different parts of the picture.

- **AF/AF lock, no AE lock:**

Press the shutter button halfway to execute AF. While holding down the <★> button, press the shutter button to take a still photo without executing AF. Convenient when you do not want to autofocus when taking a still photo during movie shooting. AE lock is not possible.

- **AE/AF, no AE lock:**

Press the shutter button halfway for metering. For AF, press the <★> button. AE lock is not possible.

- **Remote control shooting**

You can use the Remote Controller RC-6 (sold separately, p.204) to start and stop the movie shooting. Set the shooting timing switch to <2>, then press the transmit button. If the switch is set to <●> (immediate shooting), still photo shooting will take effect.



The AF mode setting will also be reflected in Live View shooting.

[] Menu



- **Movie exposure**

Normally, set this option to [**Auto**].

Setting [**Movie exposure**] to [**Manual**] enables you to manually set the ISO speed, shutter speed, and aperture for movie shooting (p.127).

- **Grid display**

With [**Grid 1** ] or [**Grid 2** ], you can display grid lines.

- **Metering timer**

You can change how long the exposure setting is displayed (AE lock time).

- **Sound recording**

When the sound recording is set to [**On**], monaural sound will be recorded with the built-in microphone. Stereo sound recording is possible by connecting an external microphone (commercially available) equipped with a stereo mini plug (3.5mm dia.) to the camera's external microphone IN terminal (p.16). The sound recording level will be adjusted automatically.

- ** Highlight tone priority**

This can be set only when [**Movie exposure**] is set to [**Manual**].

If [**Enable**] is set, highlight detail will be improved. The dynamic range is expanded from the standard 18% gray to bright highlights. The gradation between the grays and highlights becomes smoother. The ISO speed range will be ISO 200 - 6400. The Auto Lighting Optimizer will also be set automatically to [**Disable**] and cannot be changed.

 The Grid display and Metering timer settings will also be reflected in Live View shooting.

[Shooting 2] Menu



The functions settable in this menu screen only apply when the Mode Dial is set to < >. These functions do not take effect in other shooting modes.

Notes on Movie Shooting

Recording and Image Quality

- If the attached lens has an Image Stabilizer, the Image Stabilizer will operate at all times even if you do not press the shutter button halfway. The Image Stabilizer will thereby consume battery power and may shorten the total movie shooting time or decrease the number of possible shots. If you use a tripod or if the Image Stabilizer is not necessary, you should set the IS switch to <OFF>.
- The camera's built-in microphone will also pick up camera operation noise. If you use a commercially-available external microphone, you can prevent (or reduce) these noises from being recorded.
- Do not connect anything other than an external microphone to the camera's external microphone IN terminal.
- If movie shooting is not possible due to insufficient remaining capacity of the card, the movie recording size and movie shooting remaining time (p.126) will be displayed in red.
- If you use a card having a slow writing speed, a five-level indicator might appear on the right of the screen during movie shooting. It indicates how much data has not yet been written to the card (remaining capacity of the internal buffer memory). The slower the card, the faster the indicator will climb upward. If the indicator becomes full, movie shooting will stop automatically.







Indicator

If the card has a fast writing speed, the indicator will either not appear or the level (if displayed) will hardly go upward. First, shoot a few test movies to see if the card can write fast enough.

If you take still photos during movie shooting, the movie shooting might stop. Setting the still images' recording quality low might improve this problem.

Notes on Movie Shooting

About the icon and camera's internal temperature increase

- When you shoot movies continuously for a long period or in high temperatures, the camera's internal temperature may increase and the  icon may appear on the screen. Note that if you shoot movies for a long period in high temperatures, the  icon will appear earlier. Turn off the camera when not shooting movies.
- If you shoot movies while the  icon is displayed, the image quality of the movies will not be degraded. However, if you shoot still photos while the  warning icon is displayed, the image quality of still photos may be degraded. You should stop movie shooting and allow the camera to rest until the camera's internal temperature decreases.
- If movie shooting continues while the  warning icon is displayed, the camera's internal temperature will further increase and movie shooting may stop automatically. Movie shooting will be disabled until the camera's internal temperature decreases. Turn off the camera and allow the camera to rest for a while.

Playback and TV connection

- If the brightness changes during movie shooting, that part might look momentarily still when you playback the movie.
- If you connect the camera to a TV set with an HDMI cable (p.167) and shoot a movie in [1920x1080] or [1280x720], the movie being shot will be displayed at a small size on the TV. However, the actual movie will be properly recorded at the movie recording size that was set.
- If you connect the camera to a TV set (p.167, 169) and shoot a movie, the TV will not output any sound during the shooting. However, the sound will be properly recorded.

7

Handy Features

- Silencing the Beeper (p.138)
- Card Reminder (p.138)
- Setting the Image Review Time (p.138)
- Setting the Auto Power-off Time (p.139)
- Adjusting the LCD Monitor Brightness (p.139)
- File Numbering Methods (p.140)
- Auto Rotation of Vertical Images (p.142)
- Checking Camera Settings (p.143)
- Reverting the Camera to the Default Settings (p.144)
- Preventing the LCD Monitor from Turning off Automatically (p.146)
- Changing the Shooting Settings Screen Color (p.146)
- Setting the Flash (p.147)
- Automatic Sensor Cleaning (p.150)
- Appending Dust Delete Data (p.151)
- Manual Sensor Cleaning (p.153)

Handy Features

MENU Silencing the Beeper

You can prevent the beeper from sounding when focus is achieved or during self-timer operation.



Under the [📷] tab, select **[Beep]**, then press <Ⓢ>. Select **[Disable]**, then press <Ⓢ>.

MENU Card Reminder

This prevents shooting if there is no card in the camera.

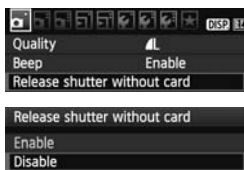

Under the [📷] tab, select **[Release shutter without card]**, then press <Ⓢ>. Select **[Disable]**, then press <Ⓢ>.

If there is no card installed and you press the shutter button, “**Card**” will be displayed in the viewfinder, and you cannot release the shutter.

MENU Setting the Image Review Time

You can set how long the image is displayed on the LCD monitor immediately after capture. If **[Off]** is set, the image will not be displayed immediately after image capture. If **[Hold]** is set, the image review will be displayed up until the **[Auto power off]** time. During the image review, if you operate any camera controls such as pressing the shutter button halfway, the image display will end.



Under the [📷] tab, select **[Image review]**, then press <Ⓢ>. Select the desired review time, then press <Ⓢ>.

MENU Setting the Auto Power-off Time

To save battery power, the camera turns off automatically after the set time of idle operation elapses. You can set this auto power-off time. When the camera has turned off due to auto power off, you can wake up the camera by pressing the shutter button halfway or any of the following buttons: <MENU> <DISP.> <▶> etc.

If [Off] has been set, either turn off the camera yourself or press the <DISP.> button to turn off the shooting settings display to save battery power.

If [Off] has been set and the camera is not used for 30 min., the LCD monitor will turn off automatically. To turn on the LCD monitor again, press the <DISP.> button.

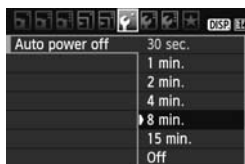

Under the [] tab, select [**Auto power off**], then press <SET>. Select the desired power-off time, then press <SET>.

MENU Adjusting the LCD Monitor Brightness

You can adjust the brightness of the LCD monitor to make it easier to read.



Under the [] tab, select [**LCD brightness**], then press <SET>. With the adjustment screen displayed, press the <◀▶> key to adjust the brightness, then press <SET>.



When checking the exposure of an image, set the LCD monitor brightness to 4 and prevent the ambient light from affecting the reviewed image.

MENU File Numbering Methods

The file number is like the frame number on a roll of film. The captured images are assigned a sequential file number from 0001 to 9999 and saved in one folder. You can change how the file number is assigned. The file number will appear on a computer in this format:
IMG_0001.JPG.

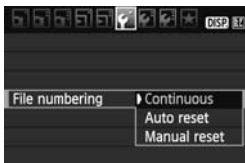

Under the [**F**] tab, select [**File numbering**], then press <SET>. The available settings are described below. Select one, then press <SET>.

- **[Continuous]: The file numbering continues in sequence even after the card is replaced.**

Even after you replace the card, the file numbering continues in sequence up to 9999. This is convenient when you want to save the images numbered anywhere between 0001 to 9999 from multiple cards into one folder in your computer.

If the replacement card contains images recorded previously, the file numbering of the new images might continue from the file numbering of the existing images in the card. If you want to use continuous file numbering, you should use a newly-formatted card each time.

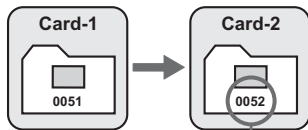
File numbering after replacing the card

Next sequential file number

- **[Auto reset]: Resets the file numbering to 0001 whenever the card is replaced.**

Each time you replace the card, the file numbering restarts from 0001. This is convenient if you want to organize images according to cards.

If the replacement card contains images recorded previously, the file numbering of the new images might continue from the file numbering of the existing images in the card. To restart the file numbering from 0001, you should use a newly-formatted card.

File numbering after replacing the card

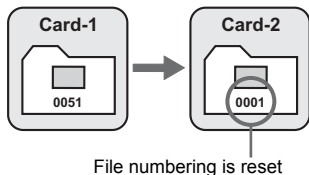

- **[Manual reset]: To reset the file numbering to 0001 manually or to start from file number 0001 in a new folder.**

When you reset the file numbering manually, a new folder is created automatically and the file numbering of images saved to that folder starts from 0001.

This is convenient if you want to use different folders for the images taken yesterday and the ones taken today, for example. After the manual reset, the file numbering returns to continuous or auto reset.



If the file number in folder No. 999 reaches 9999, shooting will not be possible even if the card still has storage capacity. The LCD monitor will display a message telling you to replace the card. Replace it with a new card.



For both JPEG and RAW images, the file name will start with "IMG_". Movie file names will start with "MVI_". The extension will be ".JPG" for JPEG images, ".CR2" for RAW images, and ".MOV" for movies.

MENU Auto Rotation of Vertical Images

Vertical images are rotated automatically so they are displayed vertically on the camera's LCD monitor and computer instead of horizontally. The setting of this feature can be changed.



Under the [F] tab, select [Auto rotate], then press <[SET]>. The available settings are described below. Select one, then press <[SET]>.

- [On] : The vertical image is automatically rotated during playback on both the camera's LCD monitor and on the computer.
- [On] : The vertical image is automatically rotated only on the computer.
- [Off] : The vertical image is not automatically rotated at all.

? FAQ

- **The vertical image is not rotated during the image review immediately after it is captured.**
Press the <[▶]> button and the image playback will display the rotated image.
- **[On] is set, but the image does not rotate during playback.**
Auto rotate will not work with vertical images captured while [Auto rotate] was set to [Off]. Also, if the vertical image is taken while the camera is pointed up or down, the image might not rotate for playback. In such a case, see "Rotating the Image" on page 159.
- **On the camera's LCD monitor, I want to rotate an image captured when [On] had been set.**
Set [On], then playback the image. It will be rotated.
- **The vertical image does not rotate on the computer screen.**
The software used is not compatible with image rotation. Use the software provided with the camera instead.

DISP. Checking Camera Settings

While the menu is displayed, press the <DISP.> button to display the camera's major function settings.

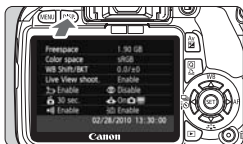

- While the menu is displayed, press the <DISP.> button to display the settings.
- Press the <DISP.> button again to return to the menu.
- Press the shutter button halfway to return to the shooting settings display.

Settings Display

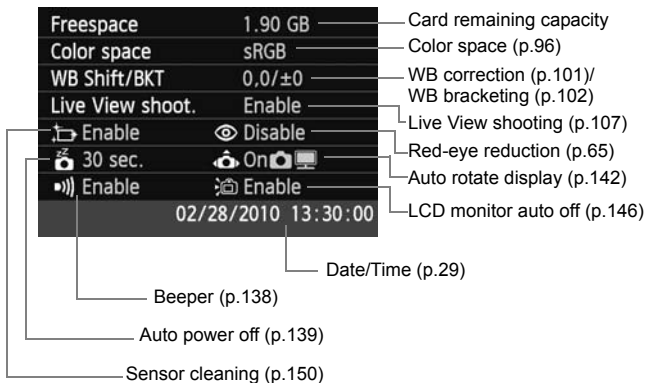

MENU Reverting the Camera to the Default Settings ☆

This is for reverting all the camera's shooting settings and Custom Functions to the default settings. This works in the <P> and other Creative Zone modes.

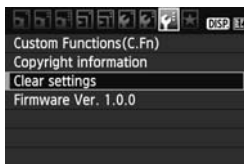
**1** Select [Clear settings].

- Under the [P] tab, select [Clear settings], then press <SET>.

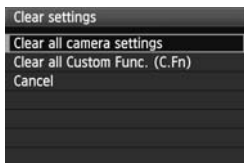
**2** Select the desired setting.

- To revert the shooting settings to the default, select [Clear all camera settings], then press <SET>.
- To revert the Custom Functions to the default settings, select [Clear all Custom Func. (C.Fn)], then press <SET>.

**3** Select [OK].

- Select [OK], then press <SET>.
- ▶ Setting [Clear all camera settings] will reset the camera to the default settings on the next page.

Shooting Settings







AF mode	One-Shot AF
AF point selection	Automatic selection
Metering mode	 (Evaluative metering)
ISO speed	AUTO (Auto)
Drive mode	 (Single shooting)
Exposure compensation/AEB	Canceled
Flash exposure compensation	0 (Zero)
Custom Functions	Unchanged

Image-recording Settings

Quality	 L
Picture Style	Standard
Auto Lighting Optimizer	Standard
Peripheral illumination correction	Enable/ Correction data retained
Color space	sRGB
White balance	 (Auto)
WB correction	Canceled
WB-BKT	Canceled
File numbering	Continuous
Auto cleaning	Enable
Dust Delete Data	Erased

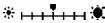

Camera Settings

Auto power off	30 sec.
Beep	Enable
Release shutter without card	Enable
Image review	2 sec.
Histogram	Brightness
Image jump w/ 	10 images
Auto rotate	On  
LCD brightness	
Date/Time	Unchanged
Language	Unchanged
Video system	Unchanged
Copyright information	Unchanged
Eye-Fi transmission	Disable
My Menu settings	Unchanged

Live View Shooting Settings

Live View shooting	Enable
Grid display	Off
Metering timer	16 sec.
AF mode	Live mode

Movie Shooting Settings

Movie-recording size	1920x1080
AF mode	Live mode
AF during 	Disable
 Shutter/ AE lock button	AF/AE lock
Remote control	Disable
Movie exposure	Auto
Grid display	Off
Metering timer	16 sec.
Sound recording	On
 Highlight tone priority	Disable

MENU Preventing the LCD Monitor from Turning off Automatically

This prevents the display-off sensor from turning off the shooting settings display automatically when your eye nears the viewfinder eyepiece.

**Select [LCD auto off].**

- Under the [P] tab, select [LCD auto off], then press <SET>. Select [Disable], then press <SET>.

MENU Changing the Shooting Settings Screen Color

You can change the background color of the shooting settings screen.

**Select [Screen color].**

- Under the [P] tab, select [Screen color], then press <SET>.
- Select the desired color, then press <SET>.
- When you exit the menu, the selected color will be displayed for the shooting settings screen.



MENU Setting the Flash ☆

The built-in flash and external Speedlite settings can be set with the menu. The [**External flash *****] menu options for external Speedlites are applicable only to an attached **EX-series Speedlite compatible with the respective functions**.

The setting procedure is the same as setting a camera menu function.

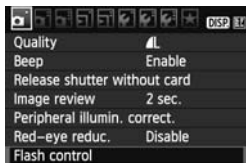

Select [Flash control].

- Under the [] tab, select [**Flash control**], then press < (SET) >.
- ▶ The flash control screen will appear.

[Flash firing]

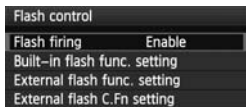

- Normally, set this to [**Enable**].
- If [**Disable**] is set, both the built-in flash and external Speedlite will **not fire**. This is useful when you only want to use the flash's AF-assist beam.

[Built-in flash func. setting] and [External flash func. setting]

The [**Built-in flash func. setting**] and [**External flash func. setting**] menus can set the functions listed on the next page. The functions displayed under [**External flash func. setting**] will vary depending on the Speedlite model.

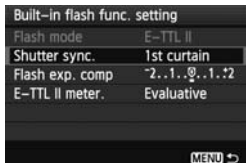

- Select [**Built-in flash func. setting**] or [**External flash func. setting**].
- ▶ The flash functions will be displayed. The functions not dimmed can be selected and set.

[Built-in flash func. setting] and [External flash func. setting] Settable Functions

Function	[Built-in flash func. setting]	[External flash func. setting]	Page
Flash mode	E-TTL II (Fixed)	○	148
Shutter sync.		○	148
FEB*	–	○	–
Flash exposure compensation		○	88
E-TTL II		○	149
Zoom*	–	○	–
Wireless setting*	–	○	–

* Regarding [FEB] (Flash exposure bracketing), [Zoom], and [Wireless set.], refer to the Speedlite's instruction manual.

● Flash mode

With an external Speedlite, you can select the flash mode to suit your flash shooting.

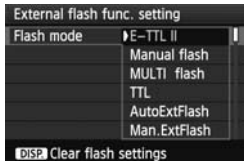

- [E-TTL II] is the standard mode of EX-series Speedlites for automatic flash shooting.
- [Manual flash] enables you to set the flash output yourself. This is for advanced users.

* For other flash modes, refer to your Speedlite's instruction manual.

● Shutter sync.

Normally, set this to [1st curtain] so that the flash fires immediately after the exposure starts.

If [2nd curtain] is set, the flash will fire right before the exposure ends. When this is combined with a slow sync speed, you can create a trail of light such as from car headlights at night. With 2nd curtain sync, two flashes will be fired: Once when you press the shutter button completely, and once immediately before the exposure ends. However, with shutter speeds faster than 1/30 sec., 1st curtain sync will automatically take effect.

If an external Speedlite is attached, you can also set [Hi-speed]. For details, see the Speedlite's instruction manual.

- **Flash exposure compensation**

See “ Flash Exposure Compensation” on page 88.

- **E-TTL II**

For normal flash exposures, set it to [**Evaluative**].

If [**Average**] is set, the flash exposure will be averaged for the entire metered scene as with an external metering flash. Since flash exposure compensation may be necessary depending on the scene, this setting is for advanced users.

- **Clear flash settings**

On the [**External flash func. setting**] screen, press the <DISP.> button to display the screen to clear the flash settings. When you select [**OK**], the settings for the built-in flash and external Speedlite will be cleared.

Setting the External Speedlite Custom Functions

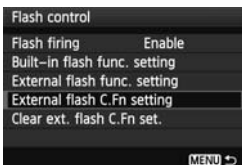

1 Display the Custom Function.

- Select [**External flash C.Fn setting**], then press <SET>.

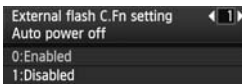

2 Set the Custom Function.

- Press the <◀▶> key, then press <SET>. The procedure is the same as setting the camera's Custom Functions (p.190).
- To clear all the Custom Function settings, select [**Clear ext. flash C.Fn set.**] in step 1.

Automatic Sensor Cleaning

Whenever you set the power switch to <ON> or <OFF>, the Self Cleaning Sensor Unit operates to automatically shake off the dust on the front of the sensor. Normally, you need not pay attention to this operation. However, you can execute the sensor cleaning at anytime as well as disable it.

Cleaning the Sensor Now



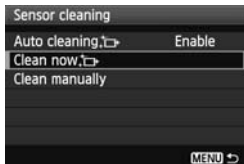

1 Select [Sensor cleaning].

- Under the [> tab, select [Sensor cleaning], then press <SET>.



2 Select [Clean now].

- Select [Clean now >], then press <SET>.
- Select [OK] on the dialog screen, then press <SET>.
- ▶ The screen will indicate that the sensor is being cleaned. Although there will be a shutter sound, a picture is not taken.

-  ● For best results, do the sensor cleaning while the camera bottom is placed on a table or other flat surface.
- Even if you repeat the sensor cleaning, the result will not improve that much. Right after the sensor cleaning is finished, the [Clean now >] option will remain disabled temporarily.

Disabling Automatic Sensor Cleaning

- In step 2, select [Auto cleaning >] and set it to [Disable].
- ▶ The sensor cleaning will no longer be executed when you set the power switch to <ON> or <OFF>.

MENU Appending Dust Delete Data ☆

Normally, the Self Cleaning Sensor Unit will eliminate most of the dust that might be visible on captured images. However, in case visible dust still remains, you can append the Dust Delete Data to the image for erasing the dust spots later. The Dust Delete Data is used by Digital Photo Professional (provided software) to erase the dust spots automatically.

Preparation

- Get a solid-white object (paper, etc.).
- Set the lens focal length to 50mm or longer.
- Set the lens focus mode switch to <MF> and set the focus to infinity (∞). If the lens has no distance scale, look at the front of the lens and turn the focusing ring clockwise all the way.

Obtain the Dust Delete Data

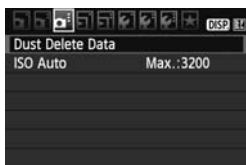

1 Select [Dust Delete Data].

- Under the [Dust Delete Data] tab, select [Dust Delete Data], then press <SET>.



2 Select [OK].

- Select [OK] and press <SET>. After the automatic self-cleaning of the sensor is performed, a message will appear. Although there will be a shutter sound, a picture is not taken.

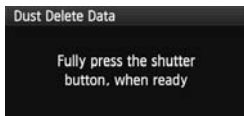

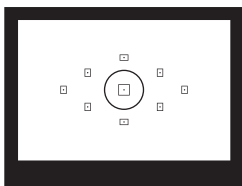

3 Photograph a solid-white object.

- At a distance of 20 cm - 30 cm (0.7 ft. - 1.0 ft.), fill the viewfinder with a patternless, solid-white object and take a picture.
- ▶ The picture will be taken in the aperture-priority AE mode with an aperture of f/22.
- Since the image will not be saved, the data can still be obtained even if there is no card in the camera.
- ▶ When the picture is taken, the camera will start obtaining the Dust Delete Data. When the Dust Delete Data is obtained, a message will appear. Select **[OK]**, and the menu will reappear.
- If the data was not obtained successfully, a message to that effect will appear. Follow the "Preparation" procedure on the preceding page, then select **[OK]**. Take the picture again.



About the Dust Delete Data

After the Dust Delete Data is obtained, it is appended to all the JPEG and RAW images captured thereafter. Before an important shoot, you should update the Dust Delete Data by obtaining it again.

To erase dust spots automatically with the provided software, see the Software Instruction Manual in the CD-ROM.

The Dust Delete Data appended to the image is so small that it hardly affects the image file size.

! Be sure to use a solid-white object such as a new sheet of white paper. If the paper has any pattern or design, it may be recognized as dust data and affect the accuracy of the dust deletion with the software.

MENU Manual Sensor Cleaning [☆]

Dust which could not be removed by the automatic sensor cleaning can be removed manually with a blower, etc.

The surface of the image sensor is extremely delicate. If the sensor needs to be cleaned directly, having it done by a Canon Service Center is recommended.

Before cleaning the sensor, detach the lens from the camera.



1 Select [Sensor cleaning].

- Under the [] tab, select [**Sensor cleaning**], then press <SET>.

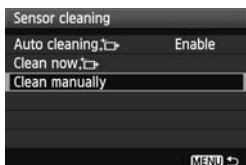

2 Select [Clean manually].

- Select [**Clean manually**], then press <SET>.



3 Select [OK].

- Select [**OK**], then press <SET>.
- ▶ In a moment, the reflex mirror will lockup and the shutter will open.

4 End the cleaning.

- Set the power switch to <OFF>.



- For the power source, using the AC Adapter Kit ACK-E8 (sold separately) is recommended.
- If you use a battery, make sure it is fully recharged. If the battery grip with size-AA/LR6 batteries is attached, manual sensor cleaning will not be possible.



- **While cleaning the sensor, never do any of the following. If the power is cut off, the shutter will close and the shutter curtains and image sensor might get damaged.**
 - **Setting the power switch to <OFF>.**
 - **Opening the battery compartment cover.**
 - **Opening the card slot cover.**
- The surface of the image sensor is extremely delicate. Clean the sensor with care.
- Use a plain blower without any brush attached. A brush can scratch the sensor.
- Do not insert the blower tip inside the camera beyond the lens mount. If the power is turned off, the shutter will close and the shutter curtains or reflex mirror might get damaged.
- Never use canned air or gas to clean the sensor. The blowing force can damage the sensor or the spray gas can freeze on the sensor.
- If smear that cannot be removed with a blower remains, having the sensor cleaned by a Canon Service Center is recommended.

8

Image Playback

This chapter explains features related to viewing photos and movies, going into more detail than in Chapter 2 “Basic Shooting and Image Playback” which explained the playback procedure. Here you will find explanations about how to playback and erase photos and movies with the camera and viewing them on a TV set.

About images taken with another camera:

The camera might not be able to properly display images captured with a different camera or edited with a computer or whose file name was changed.

▶ Searching for Images Quickly

▣ Display Multiple Images on One Screen (Index display)

Search for images quickly with the index display showing four or nine images on one screen.



1 Playback the image.

- When you press the <▶> button, the last captured image will be displayed.



2 Switch to the index display.

- Press the <▣·Q> button.
- ▶ The 4-image index display will appear. The currently-selected image will be highlighted in a blue frame.
- Press the <▣·Q> button again to switch to the 9-image index display. Pressing the <Q> button will toggle the display from 9 images, 4 images and one image displayed.



3 Select the image.

- Press the <◀▶> key to move the blue frame to select the image.
- Turn the <☀> dial to see the next screen of index images.
- Press <SET> and the selected image will be displayed as a single image.

Jump through Images (Jump display)

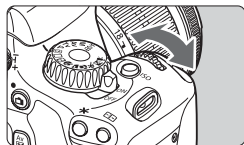
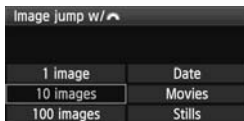

With the single image display, you can turn the  dial to jump through the images.





Jump method

Image location

1 Select the jump method.

- In the [ Image jump w/ ] menu, select the desired jump method from [1 image/10 images/100 images/Date/Movies/Stills], then press .

2 Browse by jumping.

- Press the  button to playback the image.
- On the single-image display, turn the  dial.
- ▶ The jump display will proceed according to the selected jump method.
- ▶ On the bottom right, the jump method and current image location are indicated.
- To change the jump method, press the  key.





- To search images according to the shooting date, select [Date]. Turn the  dial to display the shooting date.
- If the card contains both [Movies] and [Stills], select either one to display only movies or stills.

Magnified View

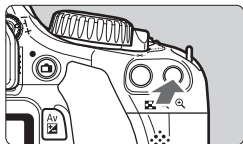
You can magnify a shot image by 1.5x to 10x on the LCD monitor.



1 Magnify the image.



- During image playback, press the  button.
- ▶ The image will be magnified.
- If you hold down the  button, the image will continue to be magnified until it reaches the maximum magnification.
- Press the  button to reduce the magnification. If you hold down the button, the magnification will continue to reduce to the single image display.



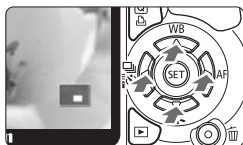

Magnified area position



2 Scroll around the image.

- Use the  key to scroll around the magnified image.
- To exit the magnified display, press the  button and the single image display will return.





-  ● You can turn the  dial to view another image while the magnification is maintained.
- Magnified view is not possible during the image review immediately after the image is taken.
- A movie cannot be magnified.

Rotating the Image

You can rotate the displayed image to the desired orientation.





1 Select [Rotate].

- Under the [>] tab, select [**Rotate**], then press < >.



2 Select the image.







- Press the <  > key to select the image to be rotated.
- You can also select an image on the index display.



3 Rotate the image.

- Each time you press < >, the image will rotate clockwise as follows: 90° → 270° → 0°
- To rotate another image, repeat steps 2 and 3.
- To exit and return to the menu, press the <MENU> button.



- If you have set [ **Auto rotate**] to [**On**  ] (p.142) before taking vertical shots, you need not rotate the image as described above.
- If the rotated image is not displayed in the rotated orientation during image playback, set the [ **Auto rotate**] menu option to [**On**  ].
- A movie cannot be rotated.

Enjoying Movies

Basically, there are the following three ways to playback the movies you shot.

Playback on a TV set (p.167, 169)



Use the provided AV cable or an HDMI Cable HTC-100 (sold separately) to connect the camera to a TV set. Then you can playback the captured movies and photos on the TV.

If you have a High-Definition TV set and connect your camera with an HDMI cable, you can watch Full HD (Full High-Definition: 1920x1080) and HD (High-Definition: 1280x720) movies with higher image quality.

- Movies on a card can be played only by devices which can play MOV files.
- Since hard disk recorders do not have an HDMI IN terminal, the camera cannot be connected with an HDMI cable.
- Even if the camera is connected to a hard disk recorder with a USB cable, movies and photos cannot be played nor saved.

Playback on the Camera's LCD Monitor (p.162-166)

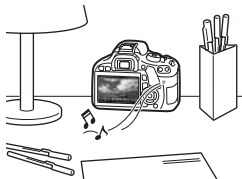

You can playback movies on the camera's LCD monitor and even edit out the first and last scenes. You can also playback photos and movies recorded in the card as an automatic slide show.

- A movie edited with a personal computer cannot be rewritten to the card and played back with the camera.

Playback and Editing with a Personal Computer

(See the PDF file instruction manual for ZoomBrowser EX/ImageBrowser)



The movie files recorded in the card can be transferred to a personal computer and played or edited with ZoomBrowser EX/ImageBrowser (provided software). You can also extract a single frame from a movie and save it as a still photo.



- For smooth movie playback, use a high-performance personal computer. Regarding the computer hardware requirements for ZoomBrowser EX/ImageBrowser, see the PDF file instruction manual.
- If you want to use commercially-available software to playback or edit the movies, be sure it is compatible with MOV files. For details on commercially-available software, inquire the software maker.

▶▶ Playing Movies



1 Playback the image.

- Press the <▶> button to display the image.



2 Select a movie.

- Press the <◀▶> key to select a movie.
- With the single-image display, the <▶ SET> icon displayed on the upper left indicates that it is a movie.
- During the index display, the perforation on the left edge of the image indicates that it is a movie.



As movies cannot be played on the index display, press <SET> to switch to the single-image display.







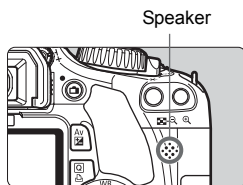











3 Press <SET>.

- On the single-image display, press <SET>.
- ▶ The movie playback panel will appear on the bottom.

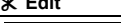

4 Playback the movie.

- Select [▶] (Play), then press <SET>.
- ▶ The movie will start playing.
- You can pause the movie playback by pressing <SET>.
- During movie playback, you can adjust the sound volume by turning the <◀▶> dial.
- For more details on the playback procedure, see the next page.

Function	Playback Description
 Exit	Returns to the single-image display.
 Play	Pressing <  > toggles between play and stop.
 Slow motion	Adjust the slow motion speed by pressing the <  > key. The slow-motion speed is indicated on the upper right.
 First frame	Displays the movie's first frame.
 Previous frame	Each time you press <  >, a single previous frame is displayed. If you hold down <  >, it will rewind the movie.
 Next frame	Each time you press <  >, the movie will play frame-by-frame. If you hold down <  >, it will fast forward the movie.
 Last frame	Displays the movie's last frame.
 Edit	Displays the editing screen (p.164).
	Playback position
mm' ss"	Playback time
 Volume	You can adjust the built-in speaker's (p.162) sound volume by turning the <  > dial.



- With a fully-charged Battery Pack LP-E8, the continuous playback time at 23°C/73°F will be as follows: Approx. 2 hr. 30 min.
- During the single-image display, press the <DISP.> button to switch the shooting information display (p.173).
- If you took a still photo while you shot the movie, the still photo will be displayed for approx. 1 sec. during the movie playback.
- If you connect the camera to a TV set (p.167, 169) to playback a movie, adjust the sound volume with the TV set. (Turning the <  > dial will not adjust the sound volume.)

✂ Editing the Movie's First and Last Scenes

You can edit out the first and last scenes of a movie in 1-sec. increments.



1 On the movie playback screen, select [✂].

- ▶ The editing screen will be displayed.



2 Specify the part to be edited out.

- Select either [✂] (Cut beginning) or [✂] (Cut end), then press <SET>.
- Press the <◀▶> key to see the previous or next frames. Holding it down will fast forward the frames.
- After deciding which part to edit out, press <SET>. The portion highlighted in blue on the top of the screen is what will remain.



3 Check the edited movie.

- Select [▶] and press <SET> to playback the portion highlighted in blue.
- To change the editing, go back to step 2.
- To cancel the editing, select [↶] and press <SET>.



4 Save the movie.

- Select [↶], then press <SET>.
- ▶ The save screen will appear.
- To save it as a new movie, select **[New file]**. To save it and overwrite the original movie file, select **[Overwrite]**. Then press <SET>.

- Since the editing is done in 1-sec. increments (position indicated by [✂]), the exact position where the movie is edited may differ slightly from the position you specified.
- If the card does not have enough room, **[New file]** will not be selectable.
- More movie editing functions are available with ZoomBrowser EX/ImageBrowser (provided software).

MENU Slide Show (Auto Playback)

You can playback the images in the card as an automatic slide show.



1 Select [Slide show].

- Under the [] tab, select [Slide show], then press <SET>.

Number of images to be played



2 Select the images to be played back.

- Press the <▲▼> key to select the top menu item, then press <SET>. Press the <▲▼> key to select one of the following: [All images/Date/Movies/Stills]. Then press <SET>.
- If you selected [Date], press the <DISP.> button while <DISP. ✓> is highlighted.
- The [Select date] screen will appear. Press the <▲▼> key to select the date, then press <SET>.



Item	Playback Description
[All images]	All the still photos and movies in the card will be played back.
[Date]	Still photos and movies taken on the selected shooting date will be played back.
[Movies]	Only the movies in the card will be played back.
[Stills]	Only the still photos in the card will be played back.



3 Set the play time and repeat option.

- Press the <▲▼> key to select [**Set up**], then press <ⓈET>.
- For still photos, set the [**Display time**] and [**Repeat**] options, then press the <MENU> button.

[Display time]

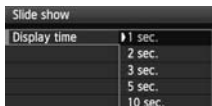

[Repeat]

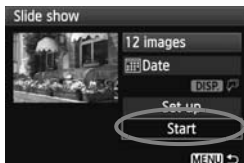

4 Start the slide show.

- Press the <▲▼> key to select [**Start**], then press <ⓈET>.
- ▶ After [**Loading image...**] is displayed, the slide show will start.

5 Quit the slide show.

- To quit the slide show and return to the setting screen, press the <MENU> button.

- To pause the slide show, press <ⓈET>. During pause, [||] will be displayed on the upper left of the image. Press <ⓈET> again to resume the slide show.
- During auto playback, you can press the <DISP.> button to change the still photo display format.
- During movie playback, you can adjust the sound volume by turning the <🔊>.
- During pause, you can press the <◀▶> key to view another image.
- During the slide show, auto power off will not take effect.
- The display time may vary depending on the image.
- To view the slide show on a TV set, see pages 167, 169.

Viewing the Images on TV

You can also view the still photos and movies on a TV set. Before connecting or disconnecting the cable between the camera and television, turn off the camera and television.

* Adjust the movie's sound volume with the TV set.

* Depending on the TV set, part of the image displayed might be cut off.

Viewing on HD (High-Definition) TV Sets

The HDMI Cable HTC-100 (sold separately) is required.

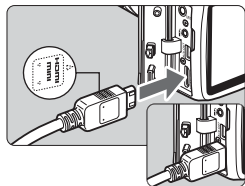

1 Connect the HDMI cable to the camera.

- Connect the HDMI cable to the camera's <HDMI OUT> terminal.
- With the plug's <▲HDMI MINI> logo facing the front of the camera, insert it into the <HDMI OUT> terminal.

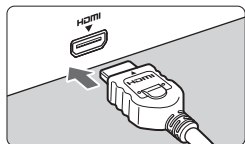

2 Connect the HDMI cable to the TV set.

- Connect the HDMI cable to the TV's HDMI IN port.

3 Turn on the TV and switch the TV's video input to select the connected port.

4 Set the camera's power switch to <ON>.

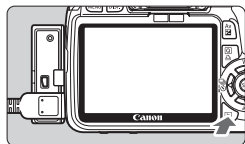

5 Press the <▶> button.

- ▶ The image will appear on the TV screen. (Nothing will be displayed on the camera's LCD monitor.)
- The images will be displayed at the TV's optimum resolution automatically.
- By pressing the <DISP.> button, you can change the display format.
- To playback movies, see page 162.



- Do not connect any other device's output to the camera's <HDMI OUT> terminal. Doing so may cause a malfunction.
- Some TVs might not be able to display the captured images. In such a case, use the provided AV cable to connect to the TV.
- The camera's <A/V OUT/DIGITAL> terminal and <HDMI OUT> terminal cannot be used at the same time.

For HDMI CEC TV sets

When a TV set compatible with HDMI CEC* is connected to the camera with the HDMI cable, you can use the TV set's remote control for playback operations.

* A function enabling you to control multiple HDMI devices with one remote control unit.



1 Select [Ctrl over HDMI].

- Under the [] tab, select [Ctrl over HDMI], then press <SET>. Select [Enable], then press <SET>.
- ▶ When the camera is connected to a TV set, the TV set's input will automatically switch to the HDMI port connected to the camera. When you press the camera's <▶> button, you can use the TV set's remote control for playback operations.

2 Select the image.

- Point the remote control to the TV set and press the ←/→ button to select the image. Then press the Enter button.
- ▶ The menu will appear. The menu displayed will differ for still photos and movies.
- Press the ←/→ button to select an option, then press the Enter button.
- ▶ For a slide show, press the remote control's ↑/↓ button to select an option, then press the Enter button.
- Select [Return] and press the Enter button. The menu will disappear and you can use the ←/→ button to select an image.



- Some TV sets require you to first enable the HDMI CEC connection. For details, see the TV set's instruction manual.
- Certain TV sets, even those compatible with HDMI CEC, may not operate properly. In such a case, set the camera's [**Ctrl over HDMI**] menu option to [**Disable**], and use the camera to control the playback operation.

Viewing on Non-HD (High-Definition) TV Sets

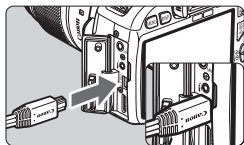

1 Connect the provided AV cable to the camera.

- Connect the AV cable to the camera's <A/V OUT / DIGITAL> terminal.
- With the plug's <Canon> logo facing the back of the camera, insert it into the <A/V OUT / DIGITAL> terminal.

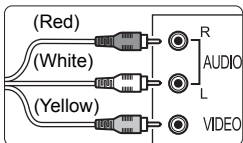

2 Connect the AV cable to the TV set.

- Connect the AV cable to the TV's video IN terminal and to the audio IN terminal.

3 Turn on the TV and switch the TV's video input to select the connected port.

4 Set the camera's power switch to <ON>.

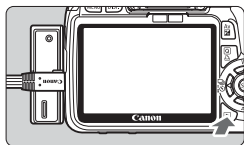

5 Press the < > button.

- ▶ The image will appear on the TV screen. (Nothing will be displayed on the camera's LCD monitor.)
- To playback movies, see page 162.



- Do not use any AV cable other than the one provided. Images might not be displayed if you use a different cable.
- If the video system format does not match the TV's, the images will not be displayed properly. Set the proper video system format with the [**Video system**] menu option.

Protecting Images

Protecting an image prevents it from being erased accidentally.





Image protect icon



1 Select [Protect images].

- Under the [] tab, select [**Protect images**], then press <SET>.
- ▶ The protect setting screen will appear.

2 Select the image and protect it.

- Press the <◀▶> key to select the image to be protected, then press <SET>.
- ▶ When an image is protected, the <> icon will appear on the top of the screen.
- To cancel the image protection, press <SET> again. The <> icon will disappear.
- To protect another image, repeat step 2.
- To exit the image protection, press the <MENU> button. The menu will reappear.

 **If you format the card (p.42), the protected images will also be erased.**

- Once an image is protected, it cannot be erased by the camera's erase function. To erase a protected image, you must first cancel the protection.
- If you erase all the images (p.172), only the protected images will remain. This is convenient when you want to erase unnecessary images all at once.

Erasing Images

You can either select and erase images one by one or erase them in one batch. Protected images (p.170) will not be erased.

- 1 **Once an image is erased, it cannot be recovered. Make sure you no longer need the image before erasing it. To prevent important images from being erased accidentally, protect them. Erasing a RAW + L image will erase both the RAW and JPEG images.**

Erasing a Single Image

- 1 Playback the image to be erased.



- 2 Press the  button.

- ▶ The erase dialog will appear at the bottom of the screen.



- 3 Erase the image.



- Select [Erase], then press . The image displayed will be erased.

MENU Checkmarking Images to be Erased in a Batch

By checkmarking the images to be erased, you can erase multiple images at one time.



- 1 Select [Erase images].

- Under the  tab, select [Erase images], then press .

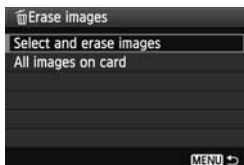

2 Select [Select and erase images].

- Select [**Select and erase images**], then press <SET>.
- ▶ The images will be displayed.
- To display the three-image display, press the <[Grid]-Q> button. To return to the single-image display, press the <Q> button.



3 Select the images to be erased.

- Select the images to be erased and press the <▲▼> key.
- ▶ The <✓> icon will be displayed on the upper left.
- To erase other images, repeat step 3.

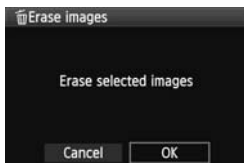

4 Erase the images.

- Press the <[Trash]> button.
- Select [OK], then press <SET>.
- ▶ The selected images will be erased.

MENU Erasing All Images in the Card

You can also erase all the images in the card. When the [**Erase images**] menu is set to [**All images on card**], all the images in the card will be erased.

 To also erase protected images, format the card (p.42).

DISP. Shooting Information Display

When you press the <DISP.> button during single-image playback, you can switch the shooting information display. The most detailed shooting information is shown below.

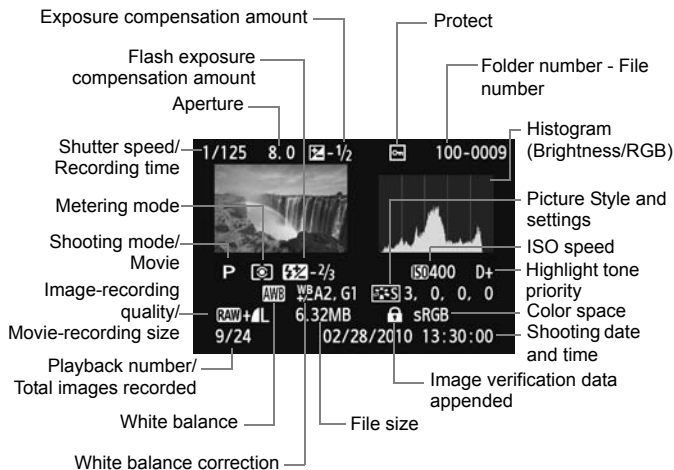

* With **RAW** + **L** images, the **L** file size is displayed.

* For movie files, the movie icon <MOV>, recording format <MOV>, recording size <1920/1280/640>, and frame rate <60/30/25/24> will be displayed. The shutter speed and aperture will not be displayed.

* For still photos taken during movie shooting display, <MOV> will be displayed.

● About the Highlight Alert

When the shooting information is displayed, any overexposed areas of the image will blink. To obtain more image detail in the overexposed areas, set the exposure compensation to a negative amount and shoot again.

● About the Histogram

The brightness histogram display shows the exposure level distribution and overall brightness. The RGB histogram display is for checking the color saturation and gradation. The display can be switched with the [ Histogram] menu.

[Brightness] Display

This histogram is a graph showing the distribution of the image's brightness level. The horizontal axis indicates the brightness level (darker on the left and brighter on the right), while the vertical axis indicates how many pixels exist for each brightness level. The more pixels there are toward the left, the darker the image. And the more pixels there are toward the right, the brighter the image. If there are too many pixels on the left, the shadow detail will be lost. And if there are too many pixels on the right, the highlight detail will be lost. The gradation in-between will be reproduced. By checking the image and its brightness histogram, you can see the exposure level inclination and the overall gradation.

Sample Histograms



Dark image



Normal brightness



Bright image

[RGB] Display

This histogram is a graph showing the distribution of each primary color's brightness level in the image (RGB or red, green, and blue). The horizontal axis indicates the color's brightness level (darker on the left and brighter on the right), while the vertical axis indicates how many pixels exist for each color brightness level. The more pixels there are toward the left, the darker and less prominent the color. And the more pixels there are toward the right, the brighter and denser the color. If there are too many pixels on the left, the respective color information will be lacking. And if there are too many pixels on the right, the color will be too saturated with no detail. By checking the image's RGB histogram, you can see the color's saturation and gradation condition and white balance inclination.

9

Printing Images

- **Printing** (p.176)
You can connect the camera directly to a printer and print out the images in the card. The camera is compatible with “PictBridge” which is the standard for direct printing.
- **Digital Print Order Format (DPOF)** (p.185)
DPOF (Digital Print Order Format) enables you to print images recorded in the card according to your printing instructions such as the image selection, quantity to print, etc. You can print multiple images in one batch or give the print order to a photofinisher.

Preparing to Print

The direct printing procedure is done entirely with the camera while you look at the LCD monitor.

Connecting the Camera to a Printer

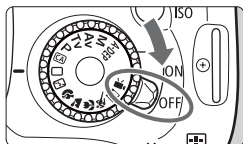

1 Set the camera's power switch to <OFF>.

2 Set up the printer.

- For details, see the printer's instruction manual.

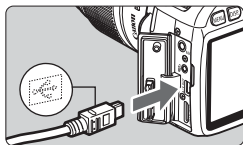

3 Connecting the camera to a printer.

- Use the interface cable provided with the camera.
- When connecting the cable plug to the camera's <A/V OUT/DIGITAL> terminal, the cable plug's <↔> icon must face the front side of the camera.
- To connect to the printer, refer to the printer's instruction manual.

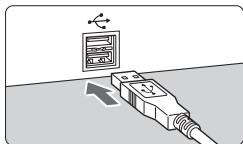

4 Turn on the printer.

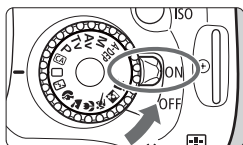

5 Set the camera's power switch to <ON>.

- ▶ Some printers may make a beeping sound.

PictBridge



6 Playback the image.

- Press the <▶> button.
- ▶ The image will appear, and the <📷> icon will appear on the upper left to indicate that the camera is connected to a printer.



- Movies cannot be printed.
- The camera cannot be used with printers compatible only with CP Direct or Bubble Jet Direct.
- Do not use any interface cable other than the one provided.
- If there is a long beeping sound in step 5, it indicates a problem with the printer. To find out what's wrong, do the following:
 1. Press the <▶> button to playback the image.
 2. Press <SET>.
 3. On the print setting screen, select **[Print]**.

The error message will be displayed on the LCD monitor (p.184).



- If you use a battery pack to power the camera, make sure it is fully charged. With a fully-charged battery, printing up to approx. 4 hours is possible.
- Before disconnecting the cable, first turn off the camera and printer. Hold the plug (not the cord) to pull out the cable.
- For direct printing, using AC Adapter Kit ACK-E8 (sold separately) to power the camera is recommended.

Printing

The screen display and setting options will differ depending on the printer. Some settings might not be available. For details, see the printer's instruction manual.



1 Select the image to be printed.

- Check that the <☞> icon is displayed on the upper left of the LCD monitor.
- Press the <◀▶> key to select the image to be printed.

2 Press <SET>.

- ▶ The print setting screen will appear.

Print setting screen

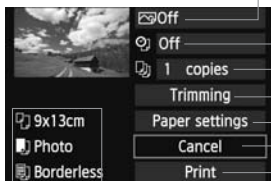

— Sets the printing effects (p.180).

— Sets the date or file number imprinting to on or off.

— Sets the quantity to be printed.

— Sets the trimming (cropping) (p.183).

— Sets the paper size, type, and layout.

— Returns to the screen in step 1.

— Starts the printing.

The paper size, type, and layout you have set are displayed.

* Depending on the printer, certain settings such as the date and file number imprinting and trimming might not be available.

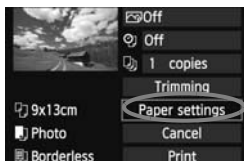

3 Select [Paper settings].

- Select [Paper settings], then press <SET>.
- ▶ The paper settings screen will appear.

Setting the Paper Size



- Select the size of the paper loaded in the printer, then press **<SET>**.
- ▶ The paper type screen will appear.

Setting the Paper Type

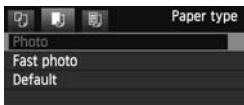

- Select the type of the paper loaded in the printer, then press **<SET>**.
- When using a Canon printer and Canon paper, read the printer's instruction manual to check what paper types can be used.
- ▶ The page layout screen will appear.

Setting the Page Layout



- Select the page layout, then press **<SET>**.
- ▶ The print setting screen will reappear.

Bordered	The print will have white borders along the edges.
Borderless	The print will have no borders. If your printer cannot print borderless prints, the print will have borders.
Bordered 	The shooting information* will be imprinted on the border on 9x13cm and larger prints.
xx-up	Option to print 2, 4, 8, 9, 16, or 20 images on one sheet.
20-up 35-up 	On A4 or Letter size paper, 20 or 35 thumbnails of the images ordered through DPOF (p.185) will be printed. • [20-up] will have the shooting information* imprinted.
Default	The page layout will vary depending on the printer model or its settings.

* From the Exif data, the camera name, lens name, shooting mode, shutter speed, aperture, exposure compensation amount, ISO speed, white balance, etc., will be imprinted.



4 Set the printing effects.

- Set as necessary. If you need not set any printing effects, go to step 5.
- **What is displayed on the screen differs depending on the printer.**
- Select the option on the upper right (circled in the screenshot), then press < **SET** >.
- Select the desired printing effect, then press < **SET** >.
- If the < **DISP.** > icon is displayed next to < **DISP.** >, you can also adjust the printing effect (p.182).

Printing Effect	Description
On	The image will be printed according to the printer's standard colors. The image's Exif data is used to make automatic corrections.
Off	No automatic correction will be applied.
VIVID	The image will be printed with higher saturation to produce more vivid blues and greens.
NR	The image noise is reduced before printing.
B/W B/W	Prints in black-and-white with true blacks.
B/W Cool tone	Prints in black-and-white with cool, bluish blacks.
B/W Warm tone	Prints in black-and-white with warm, yellowish blacks.
Natural	Prints the image in the actual colors and contrast. No automatic color adjustments are applied.
Natural M	The printing characteristics are the same as the "Natural" setting. However, this setting enables finer printing adjustments than with "Natural."
Default	The printing will differ depending on the printer. For details, see the printer's instruction manual.

* When you change the printing effects, it is reflected in the image displayed on the upper left. Note that the printed image might look slightly different from the displayed image which is only an approximation. This also applies to [Brightness] and [Adjust levels] on page 182.



5 Set the date and file number imprinting.

- Set as necessary.
- Select <Ⓞ>, then press <SET>.
- Set as desired, then press <SET>.

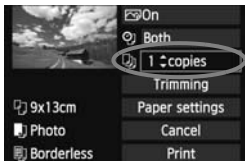

6 Set the number of copies.

- Set as necessary.
- Select <Ⓞ>, then press <SET>.
- Set the number of copies, then press <SET>.

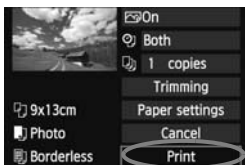

7 Start printing.

- Select [Print], then press <SET>.



- With Easy printing, you can print another image using the same settings. Just select the image and press the <Ⓞ> button. With Easy printing, the number of copies will always be 1. (You cannot set the number of copies.) Also, any trimming (p.183) will not be applied.
- The **[Default]** setting for printing effects and other options are the printer's own default settings as set by the printer's manufacturer. See the printer's instruction manual to find out what the **[Default]** settings are.
- Depending on the image's file size and image-recording quality, it may take some time for the printing to start after you select **[Print]**.
- If image tilt correction (p.183) has been applied, it may take longer to print the image.
- To stop the printing, press <SET> while **[Stop]** is displayed, then select **[OK]**.
- If you execute **[Clear all camera settings]** (p.144), all the settings will revert to the default.

Adjustment of Printing Effects

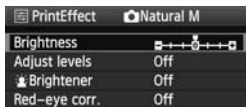
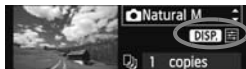

In step 4 on page 180, select the printing effect. When the  icon is displayed next to **<DISP.>**, press the **<DISP.>** button. You can then adjust the printing effect. What can be adjusted or what is displayed will depend on the selection made in step 4.

● Brightness

The image brightness can be adjusted.

● Adjust levels

When you select **[Manual]**, you can change the histogram's distribution and adjust the image's brightness and contrast.

With the Adjust levels screen displayed, press the **<DISP.>** button to change the position of the . Press the **<◀▶>** key to freely adjust the shadow level (0 - 127) or highlight level (128 - 255).

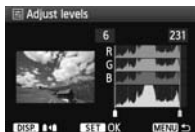

● Brightener

Effective in backlit conditions which can make the subject's face look dark. When **[On]** is set, the face will be brightened for printing.

● Red-eye corr.

Effective in flash images where the subject has red eye. When **[On]** is set, the red eye will be corrected for printing.

- The [ **Brightener**] and [**Red-eye corr.**] effects will not show on the screen.
- When you select **[Detail set.]**, you can adjust the **[Contrast]**, **[Saturation]**, **[Color tone]**, and **[Color balance]**. To adjust the **[Color balance]**, use the **<◀▶>** keys. B is for blue, A is amber, M is magenta, and G is green. The color in the respective direction will be corrected.
- If you select **[Clear all]**, all the printing effect settings will be reverted to the default.



Trimming the Image



You can crop the image and print only the trimmed portion as if the image was recomposed. **Do the trimming right before printing.** If you set the trimming and then set the print settings, you may have to set the trimming again.

- 1 On the print setting screen, select [Trimming].
- 2 Set the trimming frame size, position, and aspect ratio.
 - The image area within the trimming frame will be printed. The trimming frame's aspect ratio can be changed with [Paper settings].

Changing the trimming frame size

When you press the  or  button, the size of the trimming frame will change. The smaller the trimming frame, the larger the image magnification will be for printing.



Moving the trimming frame

Press the  key to move the frame over the image vertically or horizontally. Move the trimming frame until it covers the desired image area.

Rotating the frame

Each time you press the <DISP.> button, the trimming frame will toggle between the vertical and horizontal orientations. This enables you to create a vertical-oriented print from a horizontal image.

Image tilt correction

By turning the  dial, you can adjust the image tilt angle up to ± 10 degrees in 0.5-degree increments. When you adjust the image tilt, the  icon on the screen will turn blue.

- 3 Press <SET> to exit the trimming.

- ▶ The print setting screen will reappear.
- You can check the trimmed image area on the upper left of the print setting screen.

- Depending on the printer, the trimmed image area might not be printed as you specified.
- The smaller you make the trimming frame, the grainier the picture will look on the print.
- While trimming the image, look at the camera's LCD monitor. If you look at the image on a TV screen, the trimming frame might not be displayed accurately.



Handling Printer Errors

If you resolve a printer error (no ink, no paper, etc.) and select **[Continue]** to resume printing but it does not resume, operate the buttons on the printer to resume printing. For details on resuming the printing, see the printer's instruction manual.

Error Messages

If a problem occurs during printing, an error message will appear on the camera's LCD monitor. Press <ⓈET> to stop printing. After fixing the problem, resume printing. For details on how to fix a printing problem, refer to the printer's instruction manual.

Paper Error

Check whether the paper is properly loaded in the printer.

Ink Error

Check the printer's ink level, and check the waste ink tank.

Hardware Error

Check for any printer problems other than paper and ink problems.

File Error

The selected image cannot be printed via PictBridge. Images taken with a different camera or images edited with a computer might not be printable.

Digital Print Order Format (DPOF)

You can set the print type, date imprinting, and file No. imprinting. The print settings will be applied to all print-ordered images. (They cannot be set individually for each image.)

Setting the Printing Options

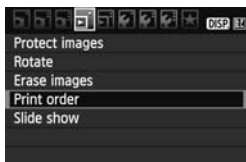

1 Select [Print order].

- Under the [] tab, select [Print order], then press <SET>.

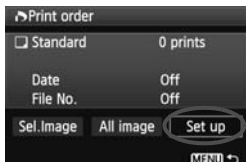

2 Select [Set up].

- Select [Set up], then press <SET>.

3 Set the option as desired.

- Set the [Print type], [Date], and [File No.].
- Select the option to be set, then press <SET>. Select the desired setting, then press <SET>.

[Print type]

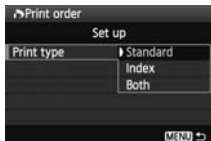

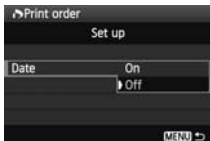

[Date]

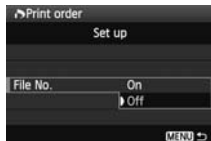

[File No.]



Print type	 Standard	Prints one image on one sheet.
	 Index	Multiple thumbnail images are printed on one sheet.
	 Both	Prints both the standard and index prints.
Date	On	[On] imprints the recorded date on the print.
	Off	
File number	On	[On] imprints the file No. on the print.
	Off	

4 Exit the setting.

- Press the <MENU> button.
- ▶ The print order screen will reappear.
- Next, select [**Sel.Image**] or [**All image**] to order the images to be printed.

- Even if [**Date**] and [**File No.**] are set to [**On**], the date or file No. might not be imprinted depending on the print type setting and printer model.
- When printing with DPOF, you must use the card whose print order specifications have been set. It will not work if you just extract images from the card and try to print them.
- Certain DPOF-compatible printers and photofinishers might not be able to print the images as you specified. If this happens with your printer, refer to the printer's instruction manual. Or check with your photofinisher about compatibility when ordering prints.
- Do not insert into the camera a card whose print order was set by a different camera and then try to specify a print order. The print order may not work or may be overwritten. Also, depending on the image type, the print order may not be possible.

- RAW images and movies cannot be print ordered.
- With [**Index**] prints, both the [**Date**] and [**File No.**] cannot be set to [**On**] at the same time.

Print Ordering

● Sel.Image



Select and order images one by one. To display the three-image display, press the < > button. To return to the single-image display, press the < > button.

After completing the print order, press the < MENU > button to save the print order to the card.



[Standard] [Both]

Press the < > key to set the number of copies to be printed for the displayed image.



[Index]

Press the < > key to checkmark the box < > and the image will be included in the index print.

● All image

If you select [**Mark all on card**], one copy of all the images in the card will be set for printing. If you select [**Clear all on card**], the print order will be cleared for all the images in the card.



- Even if you select “All image”, RAW images and movies will not be included in the print order.
- When using a PictBridge printer, print no more than 400 images for one print order. If you specify more than this, all the images might not be printed.

Direct Printing with DPOF



With a PictBridge printer, you can easily print images with DPOF.

1 Prepare to print.

- See page 176. Follow the “Connecting the Camera to a Printer” procedure up to step 5.

2 Under the [E] tab, select [Print order].

3 Select [Print].

- [Print] will be displayed only if the camera is connected to the printer and printing is possible.

4 Set the [Paper settings]. (p.178)

- Set the printing effects (p.180) if necessary.

5 Select [OK].

- Before printing, be sure to set the paper size.
- Certain printers cannot imprint the file No.
- If [Bordered] is set, certain printers might imprint the date on the border.
- Depending on the printer, the date might look light if it is imprinted on a bright background or on the border.

- Under [Adjust levels], [Manual] cannot be selected.
- If you stopped the printing and want to resume printing the remaining images, select [Resume]. Note that printing will not resume if you stop the printing and any of the following occurs:
 - Before resuming the printing, you changed the print order or deleted print-ordered images.
 - When you set the index, you changed the paper setting before resuming the printing.
 - When you paused the printing, the card's remaining capacity was low.
- If a problem occurs during printing, see page 184.

10

Customizing the Camera

You can customize various camera features to suit your picture-taking preferences. You can do it with Custom Functions. Custom Functions can be set and used only in Creative Zone modes.

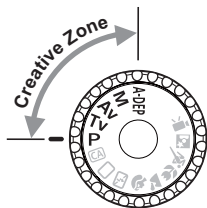

MENU Setting Custom Functions ☆

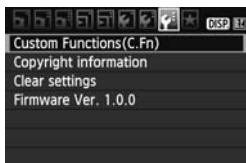

1 Select [Custom Functions (C.Fn)].

- Under the [] tab, select [Custom Functions (C.Fn)], then press <SET>.

Custom Function No.

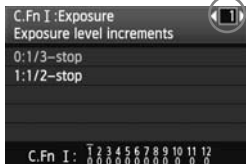

2 Select the Custom Function No.

- Press the <◀▶> key to select the Custom Function No., then press <SET>.

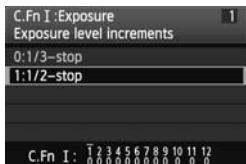

3 Change the setting as desired.

- Press the <▲▼> key to select the setting (number), then press <SET>.
- Repeat steps 2 and 3 if you want to set other Custom Functions.
- At the bottom of the screen, the current Custom Function settings are indicated below the respective function numbers.

4 Exit the setting.

- Press the <MENU> button.
- ▶ The screen for step 1 will reappear.

Clearing All Custom Functions

On the [: Clear settings] menu, select [Clear all Custom Func. (C.Fn)] to clear all the Custom Function settings (p.144).

Custom Functions

C.Fn I: Exposure

			 LV shooting
1	Exposure level increments	p.192	<input type="radio"/>
2	ISO expansion		<input type="radio"/>
3	Flash sync. speed in Av mode		<input type="radio"/>

* The C.Fn I -1 setting will also be applied to movie shooting.

C.Fn II: Image

4	Long exposure noise reduction	p.193	<input type="radio"/>
5	High ISO speed noise reduction		<input type="radio"/>
6	Highlight tone priority	p.194	<input type="radio"/>

C.Fn III: Autofocus/Drive

7	AF-assist beam firing	p.194	<input type="radio"/>
8	Mirror lockup	p.195	

C.Fn IV: Operation/Others

9	Shutter/AE lock button	p.195	<input type="radio"/>
10	Assign SET button	p.196	
11	LCD display when power ON		<input type="radio"/>
12	Add image verification data	p.197	<input type="radio"/>

 The shaded Custom Functions do not work during Live View (LV) shooting. (Settings are disabled.)

MENU Custom Function Settings [☆]

Custom Functions are organized into four groups based on the function type: C.Fn I: Exposure, C.Fn II: Image, C.Fn III: Autofocus/Drive, C.Fn IV: Operation/Others.

C.Fn I: Exposure

C.Fn-1 Exposure level increments

0: 1/3-stop

1: 1/2-stop

Sets 1/2-stop increments for the shutter speed, aperture, exposure compensation, AEB, flash exposure compensation, etc. Effective when you prefer to control the exposure in less fine increments than 1/3-stop increments.

 The exposure level will be displayed in the viewfinder and on the LCD monitor as shown below.



C.Fn-2 ISO expansion

0: Off

1: On

For the ISO speed, "H" (equivalent to ISO 12800) will be selectable. However, if [**C.Fn-6: Highlight tone priority**] is set to [**1: Enable**], "H" cannot be set.

C.Fn-3 Flash sync. speed in Av (Aperture-priority AE) mode

0: Auto

The flash sync speed is set automatically within a range of 1/200 sec. to 30 sec. to suit the scene's brightness.

1: 1/200-1/60 sec. auto

When flash is used with aperture-priority AE (**Av**), this prevents a slow flash-sync speed from being set automatically in low-light conditions. It is effective for preventing subject blur and camera shake. However, while the subject will be properly exposed with the flash, the background will come out dark.

2: 1/200 sec. (fixed)

The flash-sync speed is fixed to 1/200 sec. This more effectively prevents subject blur and camera shake than with setting 1. However, the background may come out darker than with setting 1.



When 1 or 2 is set, high-speed sync cannot be used with an external Speedlite.

C.Fn II: Image

C.Fn-4 Long exposure noise reduction

0: Off

1: Auto

For 1 sec. or longer exposures, noise reduction is performed automatically if noise typical of long exposures is detected. This **[Auto]** setting is effective in most cases.

2: On

Noise reduction is performed for all exposures of 1 sec. or longer. The **[On]** setting may be effective for noise that cannot be detected or reduced with the **[Auto]** setting.



- With setting 1 and 2, after the picture is taken, the noise reduction process may take the same amount of time as the exposure. You cannot take another picture until the noise reduction process is completed.
- At ISO 1600 and higher, noise might be more pronounced with setting 2 than with setting 0 or 1.
- With setting 2, if a long exposure is shot during Live View display, "BUSY" will be displayed during the noise reduction process. The Live View display will not appear until the noise reduction is completed. (You cannot take another picture.)

C.Fn-5 High ISO speed noise reduction

Reduces the noise generated in the image. Although noise reduction is applied at all ISO speeds, it is particularly effective at high ISO speeds. At low ISO speeds, the noise in the shadow areas is further reduced. Change the setting to suit the noise level.

0: Standard

1: Low

2: Strong

3: Disable



With setting 2, the maximum burst for continuous shooting will greatly decrease.

C.Fn-6 Highlight tone priority

0: Disable

1: Enable

Improves the highlight detail. The dynamic range is expanded from the standard 18% gray to bright highlights. The gradation between the grays and highlights becomes smoother.

-  ● With setting 1, the **[Disable]** setting automatically takes effect for the Auto Lighting Optimizer (p.103) and it cannot be changed.
- With setting 1, noise may become slightly more pronounced than usual.

 With setting 1, the settable ISO speed range will be 200 - 6400. Also, the <D+> icon will be displayed on the LCD monitor and in the viewfinder when highlight tone priority is enabled.

C.Fn III: Autofocus/Drive

C.Fn-7 AF-assist beam firing

The AF-assist beam can be emitted by the camera's built-in flash or by an external, EOS-dedicated Speedlite.

0: Enable

1: Disable

The AF-assist beam is not emitted.

2: Enable external flash only

If an external, EOS-dedicated Speedlite is attached, it will emit the AF-assist beam when necessary. The camera's built-in flash will not fire the AF-assist beam.

3: IR AF assist beam only

Among EOS-dedicated Speedlites, only those which have an infrared AF-assist beam will be able to emit the beam. This prevents any Speedlite which uses a series of small flashes (like the built-in flash) from firing the AF-assist beam.

 If the external, EOS-dedicated Speedlite's **[AF-assist beam firing]** Custom Function is set to **[Disabled]**, the Speedlite will not emit the AF-assist beam even if the camera's C.Fn-7-0/2/3 is set.

C.Fn-8 Mirror lockup**0: Disable****1: Enable**

Prevents camera vibrations caused by the reflex mirror action which can disturb shooting with super telephoto lenses or close-up (macro) shooting. See page 106 for the mirror lockup procedure.

C.Fn IV: Operation/Others**C.Fn-9 Shutter/AE lock button****0: AF/AE lock****1: AE lock/AF**

Convenient when you want to focus and meter separately. Press the <★> button to autofocus, and press the shutter button halfway to apply AE lock.

2: AF/AF lock, no AE lock

In the AI Servo AF mode, you can press the <★> button to stop the AF operation momentarily. This prevents the AF from being thrown off by any obstacle passing between the camera and subject. The exposure is set at the moment the picture is taken.

3: AE/AF, no AE lock

This is useful for subjects which keep moving and stopping repeatedly. In the AI Servo AF mode, you can press the <★> button to start or stop the AI Servo AF operation. The exposure is set at the moment the picture is taken. Thus, the optimum focusing and exposure will always be achieved as you wait for the decisive moment.



When 1 or 3 is set, pressing the Remote Switch (p.205) halfway will not work.

C.Fn-10 Assign SET button

You can assign a frequently-used function to <SET>. Press <SET> when the camera is shooting-ready.

0: Normal (disabled)

1: Image quality

Press <SET> to display the image-recording quality setting screen on the LCD monitor.

Press the <◇> key to select the image-recording quality, then press <SET>.

2: Flash exposure compensation

When you press <SET>, the flash exposure compensation setting screen will appear.

3: LCD monitor On/Off

Assigns the same function as the <DISP.> button.

4: Menu display

Assigns the same function as the <MENU> button.

5: ISO speed

Assigns the same function as the <ISO> button.

C.Fn-11 LCD display when power ON

0: Display on

When the power switch is turned on, the shooting settings will be displayed (p.44).

1: Previous display status

If you pressed the <DISP.> button and turned off the camera while the LCD monitor was off, the shooting settings will not be displayed when you turn on the camera again. This helps to save battery power. The menu screens and image playback will still be displayed when used. If you pressed the <DISP.> button and turned off the camera while the LCD monitor was on, the shooting settings will be displayed when you turn on the camera again.

C.Fn-12 Add image verification data

0: Disable

1: Enable

Data for verifying whether the image is original or not is appended to the image automatically. When the shooting information of an image appended with the verification data is displayed (p.173), the <  > icon will appear.

To verify whether the image is original, the Original Data Security Kit OSK-E3 (sold separately) is required.



The images are not compatible with the image encryption/decryption features of Original Data Security Kit OSK-E3.

MENU Registering My Menu ☆

Under the My Menu tab, you can register up to six menu options and Custom Functions whose settings you change frequently.

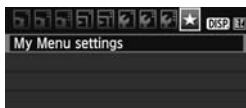

- 1 **Select [My Menu settings].**
 - Under the [★] tab, select [My Menu settings], then press <SET>.

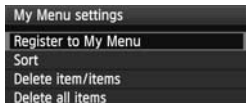

- 2 **Select [Register to My Menu].**
 - Select [Register to My Menu], then press <SET>.

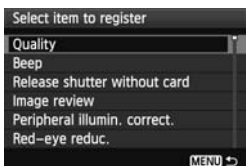

- 3 **Register the desired items.**
 - Select the item to be registered, then press <SET>.
 - On the confirmation dialog, select [OK] and press <SET> to register the item.
 - You can register up to six items in My Menu.
 - To return to the screen in step 2, press the <MENU> button.

About My Menu settings

- **Sort**

You can change the order of the registered items in My Menu. Select [Sort] and select the item whose order you want to change. Then press <SET>. With [◆] displayed, press the <▲▼> key to change the order, then press <SET>.

- **Delete item/items and Delete all items**

You can delete any of the registered items. [Delete item/items] deletes one item at a time, and [Delete all items] deletes all items.

- **Display from My Menu**

When [Enable] is set, the [★] tab will be displayed first when you display the menu screen.

MENU Setting Copyright Information ☆

When you set the copyright information, it will be appended to the image as Exif information.

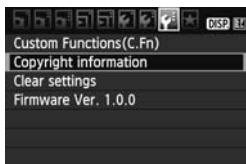

1 Select [Copyright information].

- Under the [**☛**] tab, select [**Copyright information**], then press <**SET**>.



2 Select the desired option.

- Press the <**▲▼**> key to select either [**Enter author's name**] or [**Enter copyright details**], then press <**SET**>.
- ▶ The text entry screen will appear.
- Select [**Display copyright info.**] to check the copyright information currently set.
- Select [**Delete copyright information**] to delete the copyright information currently set.



3 Enter text.

- Refer to “Text Entry Procedure” on the next page and enter the copyright information.
- Enter up to 63 alphanumeric characters and symbols.

4 Exit the setting.

- After entering the text, press the <**MENU**> button to exit.

Text Entry Procedure



- **Changing the entry area**
Press the <Q> button to toggle between the top and bottom entry areas.
- **Moving the cursor**
Press the <◀▶> key to move the cursor.

- **Entering text**

In the bottom area, press the <◆> key to select a character, then press <SET> to enter it.

- **Deleting a character**

Press the <🗑️> button to delete a character.

- **Exiting**

After completing the text entry, press the <MENU> button to return to the screen in step 2.

- **Canceling the text entry**

To cancel the text entry, press the <DISP.> button to return to the screen in step 2.

 You can also enter the copyright information with EOS Utility (provided software).

11

Reference

This chapter provides reference information for camera features, system accessories, etc. The back of this chapter also has an index to make it easier to look up needed information.

When Autofocus Fails

Autofocus can fail to achieve focus (the focus confirmation light <●> blinks) with certain subjects such as the following:

Subjects difficult to focus

- Very low-contrast subjects
(Example: Blue sky, solid-color walls, etc.)
- Subjects in very low light
- Extremely backlit or reflective subjects
(Example: Car with a highly reflective body, etc.)
- Near and far subjects covered by an AF point
(Example: Animal in a cage, etc.)
- Repetitive patterns
(Example: Skyscraper windows, computer keyboards, etc.)

In such cases, do one of the following:

- (1) With One-Shot AF, focus an object at the same distance as the subject and lock the focus before recomposing (p.48).
- (2) Set the lens focus mode switch to <MF> and focus manually.



- If an Extender (sold separately) is attached and the maximum aperture of the lens is f/5.6 or smaller (larger f/number), AF will not be possible (except Live mode/ Live mode AF). For details, see the Extender's instruction manual.
- For situations where AF can fail to achieve focus with Live mode/ Live mode AF, see page 117.

Using a Household Power Outlet

With the AC Adapter Kit ACK-E8 (sold separately), you can connect the camera to a household power outlet and not worry about the battery level.

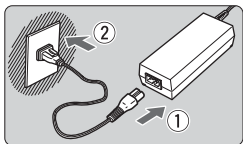

1 Connect the power cord.

- Connect the power cord as shown in the illustration.
- After using the camera, unplug the power plug from the power outlet.

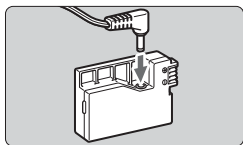

2 Connect the DC Coupler.

- Connect the cord's plug to the DC Coupler.

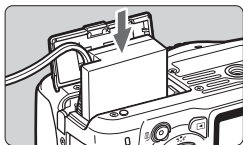

3 Insert the DC Coupler.

- Open the cover and insert the DC Coupler until it locks in place.

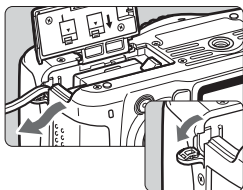

4 Push in the DC cord.

- Open the DC cord hole cover and install the cord as shown.
- Close the cover.



Do not connect or disconnect the power cord while the camera's power switch is set to <ON>.

Remote Control Shooting

Remote Controller RC-6 (Sold separately)

This remote controller enables you to take pictures wirelessly up to about 5 meters/16.4 feet from the camera. You can either shoot immediately or use a 2-sec. delay.

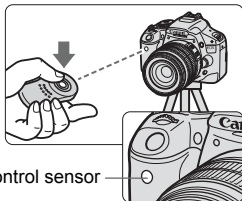

Remote control sensor

- Set the self-timer to  (p.71).
- Point the remote controller toward the camera's remote control sensor and press the transmit button.
- ▶ The camera will autofocus.
- ▶ When focus is achieved, the self-timer lamp will light and the picture will be taken.

 Camera misoperation may occur near certain types of fluorescent lights. During wireless remote control, try to keep the camera away from fluorescent light sources.

 The remote controller RC-1/RC-5 (sold separately) can also be used.

Remote Switch RS-60E3 (Sold separately)

This remote switch has a 60 cm/2.0 feet cord and enables you to press the shutter button halfway or completely. It connects to the camera's remote control terminal.

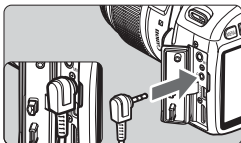

Using the Eyepiece Cover

If you take a picture without looking at the viewfinder, light entering the eyepiece can throw off the exposure. To prevent this, use the eyepiece cover (p.23) attached to the camera strap.

During Live View shooting and movie shooting, attaching the eyepiece cover is unnecessary.

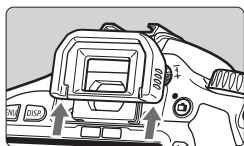

1 Remove the eyecup.

- Push the bottom of the eyecup upward.

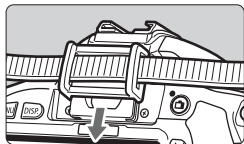

2 Attach the eyepiece cover.

- Slide the eyepiece cover down into the eyepiece groove to attach it.

External Speedlites

EOS-dedicated, EX-series Speedlites

Basically operates like a built-in flash for easy operation.

When an EX-series Speedlite (sold separately) is attached to the camera, almost all the autoflash control is done by the camera. In other words, it is like a high-output flash attached externally in place of the built-in flash.



For detailed instructions, see the EX-series Speedlite's instruction manual. This camera is a Type-A camera that can use all the features of EX-series Speedlites.



Shoe-mount Speedlites



Macro Lites

- With an EX-series Speedlite not compatible with flash function settings (p.147), only **[Flash exp. comp]** and **[E-TTL II meter.]** can be set for **[External flash func. setting]**. (Certain EX-series Speedlites also enable **[Shutter sync.]** to be set.)
- If flash exposure compensation is set with the external Speedlite, the flash exposure compensation icon displayed on the camera's LCD monitor will change from  to .
- If the flash metering mode is set to TTL autoflash with the Speedlite's Custom Function, the flash will fire at full output only.

Canon Speedlites other than the EX-series

- **With an EZ/E/EG/ML/TL-series Speedlite set in TTL or A-TTL autoflash mode, the flash can be fired at full output only.** Set the camera's shooting mode to <M> (manual exposure) or <Av> (aperture-priority AE) and adjust the aperture setting before shooting.
- When using a Speedlite which has manual flash mode, shoot in the manual flash mode.

Using Non-Canon Flash Units

Sync Speed

The camera can synchronize with compact, non-Canon flash units at 1/200 sec. or slower. Be sure to test the flash unit beforehand to make sure it synchronizes properly with the camera.

Cautions for Live View shooting

A non-Canon flash will not fire during Live View shooting.



- If the camera is used with a flash unit or flash accessory dedicated to another camera brand, the camera may not operate properly and malfunction may result.
- Do not attach a high-voltage flash unit on the camera's hot shoe. It might not fire.

Using Eye-Fi Cards

With a commercially-available Eye-Fi card already set up, you can automatically transfer captured images to a personal computer or upload them to an online service via a wireless LAN.

The image transfer is a function of the Eye-Fi card. To set up, use the card and to troubleshoot any image transfer problems, refer to the Eye-Fi card's instruction manual or inquire the card's manufacturer.

ⓘ This product is not guaranteed to support Eye-Fi card functions (including wireless transfer). In case of an issue with an Eye-Fi card, please check with the card manufacturer. Also note that an approval is required to use Eye-Fi cards in many countries or regions. Without approval, use of the card is not permitted. If it is unclear whether the card has been approved for use in the area, please check with the card manufacturer.

1 Insert an Eye-Fi card. (p.31)



2 Select [Eye-Fi settings].

- Under the [**ⓘ**] tab, select [**Eye-Fi settings**], then press <[**SET**]>.
- This menu is displayed only when an Eye-Fi card has been loaded in the camera.



3 Enable the Eye-Fi transmission.

- Press <[**SET**]>, set [**Eye-Fi trans.**] to [**Enable**], then press <[**SET**]>.
- If you set [**Disable**], automatic transmission will not occur even with the Eye-Fi card loaded (Transmission status icon )

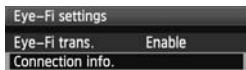

4 Display the connection information.

- Select [**Connection info.**], then press <[**SET**]>.



5 Check the [Access point SSID:].

- Check that an access point is displayed for [Access point SSID:].
- You can also check the Eye-Fi card's MAC address and firmware version.
- Press the <MENU> button three times to exit the menu.

6 Take the picture.

- ▶ The picture is transferred and the <Wi-Fi icon> switches from gray (Not connected) to the icons below.
- For transferred images, [Image icon] is displayed in the detailed information display (p.58).

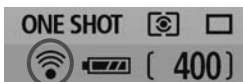

Transmission status icon

- (Gray) **Not connected** : No connection with access point.
- (Blinking) **Connecting** : Connecting with access point.
- (Displayed) **Connected** : Connection to access point established.
- (↑) **Transferring** : Image transmission to access point in progress.

⚠ Cautions for Using Eye-Fi Cards

- If “” is displayed, an error occurred while retrieving the card information. Turn the camera off and on again.
- Even if [Eye-Fi trans.] is set to [Disable], it may still transmit a signal. In hospitals, airports, and other places where wireless transmissions are prohibited, remove the Eye-Fi card from the camera.
- If the image transfer does not work, check the Eye-Fi card and personal computer settings. For details, see the card's instruction manual.
- Depending on the wireless LAN's connection conditions, the image transfer may take longer or might be interrupted.
- Because of the transmission function, the Eye-Fi card may become hot.
- The battery power will be consumed faster.
- During the image transfer, auto power off will not take effect.

Function Availability Table according to Shooting Modes ■

● : Set automatically ○ : User selectable □ : Not selectable

Mode Dial		Basic Zone							Creative Zone					Movie shooting	
		□	📷	👤	🏔️	🌿	🏠	📷	CA	P	Tv	Av	M	A-DEP	🎬
Quality	JPEG	○	○	○	○	○	○	○	○	○	○	○	○	○	Stills
	RAW	○	○	○	○	○	○	○	○	○	○	○	○	○	
	RAW + 📷L	○	○	○	○	○	○	○	○	○	○	○	○	○	
ISO speed	Auto	●	●	●	●	●	●	●	○	○	○	○	○	○	
	Manual	□	□	□	□	□	□	□	○	○	○	○	○	○*1	
Picture Style	Standard	●	●	□	□	●	●	●	○	○	○	○	○	○	
	Portrait	□	□	●	□	□	□	□	○	○	○	○	○	○	
	Landscape	□	□	□	●	□	□	□	○	○	○	○	○	○	
	Neutral	□	□	□	□	□	□	□	○	○	○	○	○	○	
	Faithful	□	□	□	□	□	□	□	○	○	○	○	○	○	
	Monochrome	□	□	□	□	□	□	□	○	○	○	○	○	○	
	User Defined	□	□	□	□	□	□	□	○	○	○	○	○	○	
White balance	Auto WB	●	●	●	●	●	●	●	○	○	○	○	○	○	
	Preset WB	□	□	□	□	□	□	□	○	○	○	○	○	○	
	Custom WB	□	□	□	□	□	□	□	○	○	○	○	○	○	
	WB correction	□	□	□	□	□	□	□	○	○	○	○	○	□	
	WB bracketing	□	□	□	□	□	□	□	○	○	○	○	○	□	
Auto Lighting Optimizer		●	●	●	●	●	●	●	○	○	○	○	○	○	
Peripheral illumination correction		○	○	○	○	○	○	○	○	○	○	○	○	○	
Long exposure noise reduction		●	●	●	●	●	●	●	○	○	○	○	○	●	
AF	One-Shot	□	□	●	●	●	□	●	○	○	○	○	●	●	
	AI Servo	□	□	□	□	□	●	□	○	○	○	○	□	□	
	AI Focus	●	●	□	□	□	□	□	○	○	○	○	□	□	
	AF point selection	Auto	●	●	●	●	●	●	●	○	○	○	○	●	○
		Manual	□	□	□	□	□	□	□	○	○	○	○	□	○
AF-assist beam		●	□	●	□	●	□	●	○	○	○	○	○	□	

Mode Dial		Basic Zone							Creative Zone					Movie shooting
									P	Tv	Av	M	A-DEP	
Metering mode	Evaluative	●	●	●	●	●	●	●	○	○	○	○	○	
	Partial								○	○	○	○	○	
	Spot								○	○	○	○	○	
	Center-weighted average								○	○	○	○	○	
Exposure	Program shift							○*2	○					
	Exposure compensation							○*3	○	○	○		○	○*4
	AEB								○	○	○	○	○	
	AE lock								○	○	○		○	○*4
	Depth-of-field preview								○	○	○	○	○	
Drive	Single	●	●		●	●		●	○	○	○	○	○	Stills
	Continuous			●				●	○	○	○	○	○	
	Self-timer/Remote control	○	○	○	○	○	○	○	○	○	○	○	○	○*5
	Self-timer:2 sec								○	○	○	○	○	
	Self-timer:Continuous	○	○	○	○	○	○	○	○	○	○	○	○	
Built-in flash	Auto	●		●		●		●	○					
	Manual								○	○	○	○	○	
	Flash off		●		●		●		○					●
	Red-eye reduction	○		○		○		○	○	○	○	○	○	
	FE lock									○	○	○	○	○
	Flash exposure compensation								○*3	○	○	○	○	○
Color space	sRGB	●	●	●	●	●	●	●	○	○	○	○	○	●
	Adobe RGB									○	○	○	○	○
Live View shooting		○	○	○	○	○	○	○	○	○	○	○	○	●

*1: For manual exposure only.

*2: Refers to “(2) Blurring/sharpening the background” function on page 56.

*3: Refers to “(3) Adjusting the picture brightness” function on page 56.







*4: For autoexposure only.

*5: On the movie shooting mode menu, [Remote control] can be set.











Menu Settings





Shooting 1 (Red)

Page

Quality	 L /  L /  M /  M /  S /  S / RAW+  L / RAW	72
Beep	Enable / Disable	138
Release shutter without card	Enable / Disable	138
Image review	Off / 2 sec. / 4 sec. / 8 sec. / Hold	138
Peripheral illumination correction	Enable / Disable	104
Red-eye reduction	Disable / Enable	65
Flash control	Flash firing / Built-in flash function setting / External flash function setting / External flash C.Fn setting / Clear external flash C.Fn setting	147

Shooting 2 (Red)

Exposure compensation/AEB	1/3-stop increments, ±5 stops (AEB: ±2 stops)	89
Auto Lighting Optimizer	Disable / Low / Standard / Strong	103
Metering mode	 /  /  / 	86
Custom White Balance	Manual setting of white balance	99
WB Shift/BKT	WB correction: White balance correction WB-BKT: White balance bracketing	101 102
Color space	sRGB / Adobe RGB	96
Picture Style	 Standard /  Portrait /  Landscape /  Neutral /  Faithful /  Monochrome /  User Def. 1, 2, 3	75 91 94

- The  Shooting 2,  Shooting 3,  Set-up 3, and  My Menu screens (tabs) are not displayed in Basic Zone modes.
- Shaded menu options are not displayed in Basic Zone modes.

📷 Shooting 3 (Red)

Page

Dust Delete Data	Obtains data to be used to erase dust spots	151
ISO Auto	Max. 400 / Max. 800 / Max. 1600 / Max. 3200 / Max. 6400	63



🔄 Playback 1 (Blue)

Protect images	Erase-protect images	170
Rotate	Rotate vertical images	159
Erase images	Erase images	171
Print order	Specify images to be printed (DPOF)	185
Slide show	Select the images and set the Display time and Repeat settings for automatic playback	165

🔄 Playback 2 (Blue)

Histogram	Brightness / RGB	174
Image jump w/ 	1 image / 10 images / 100 images / Date / Movies / Stills	157
Ctrl over HDMI	Disable / Enable	168

🔧 Set-up 1 (Yellow)

Auto power off	30 sec. / 1 min. / 2 min. / 4 min. / 8 min. / 15 min. / Off	139
Auto rotate	On   / On  / Off	142
Format	Initialize and erase data in the card	42
File numbering	Continuous / Auto reset / Manual reset	140
LCD auto off	Enable / Disable	146
Screen color	Select the background color	146
Eye-Fi settings*	Eye-Fi transmission: Disable / Enable Connection information	208

* Displayed only when an Eye-Fi card is used.

☛ Set-up 2 (Yellow)

Page

LCD brightness	Seven brightness levels provided	139
Date/Time	Set the date (year, month, day) and time (hour, min., sec.)	29
Language 🌐	Select the interface language	30
Video system	NTSC / PAL	169
Sensor cleaning	Auto cleaning: Enable / Disable	150
	Clean now	
	Clean manually	153
Live View function settings	Live View shooting / Grid display / Metering timer / AF mode	108

☛ Set-up 3 (Yellow)

Custom Functions (C.Fn)	Customize camera functions as desired	190
Copyright information	Display copyright information / Enter author's name / Enter copyright details / Delete copyright information	199
Clear settings	Clear all camera settings / Clear all Custom Func. (C.Fn)	144
Firmware Ver.	For updating the firmware	—



★ My Menu (Green)

My Menu settings	Register frequently-used menu items and Custom Functions	198
-------------------------	--	-----



Movie Shooting Mode Menu

Movie 1 (Red)

Page

Movie recording size	1920x1080 (1920 / 1080 / 1080) / 1280x720 (1280 / 720) / 640x480 (640 / 480) / Crop 640x480 (640 / 480)	131
AF mode	Live mode /  Live mode / Quick mode	132
AF during 	Disable / Enable	132
 Shutter/AE lock button	AF/AE lock / AE lock/AF / AF/AF lock, no AE lock / AE/AF, no AE lock	133
Remote control	Disable / Enable	133











Movie 2 (Red)

Movie exposure	Auto / Manual	134
Grid display	Off / Grid 1  / Grid 2 	134
Metering timer	4 sec. / 16 sec. / 30 sec. / 1 min. / 10 min. / 30 min.	134
Sound recording	On / Off	134
 Highlight tone priority*	Disable / Enable	134

* Displayed only when [Movie exposure] is set to [Manual].



About the menu screen in movie shooting mode

- The [] Movie 1 and [] Movie 2 screens (tabs) are displayed only in the movie shooting mode.
- The [] Shooting 3, [] Set-up 3, and [] My Menu screens (tabs) will not be displayed.
- Under the [] tab, the [Expo. comp./AEB] option will become [Exposure comp.].
- The following menu items will not be displayed:
 - []: Red-eye reduction, Flash control
 - []: Metering mode, WB Shift/BKT, Color space
 - []: LCD auto off, Screen color
 - []: Sensor cleaning, Live View function settings

System Map

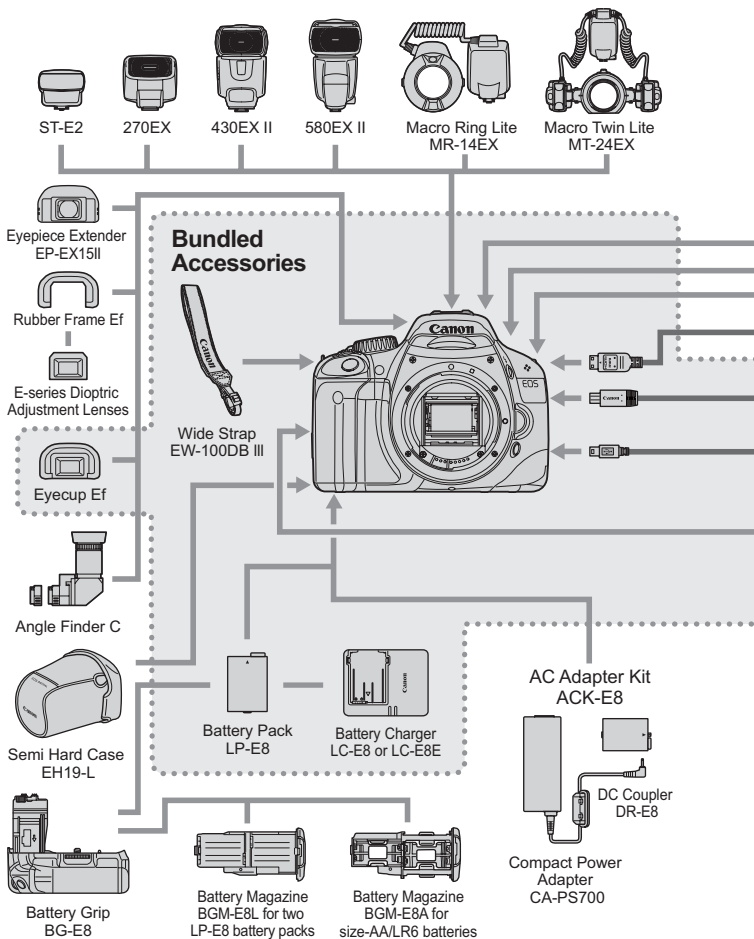

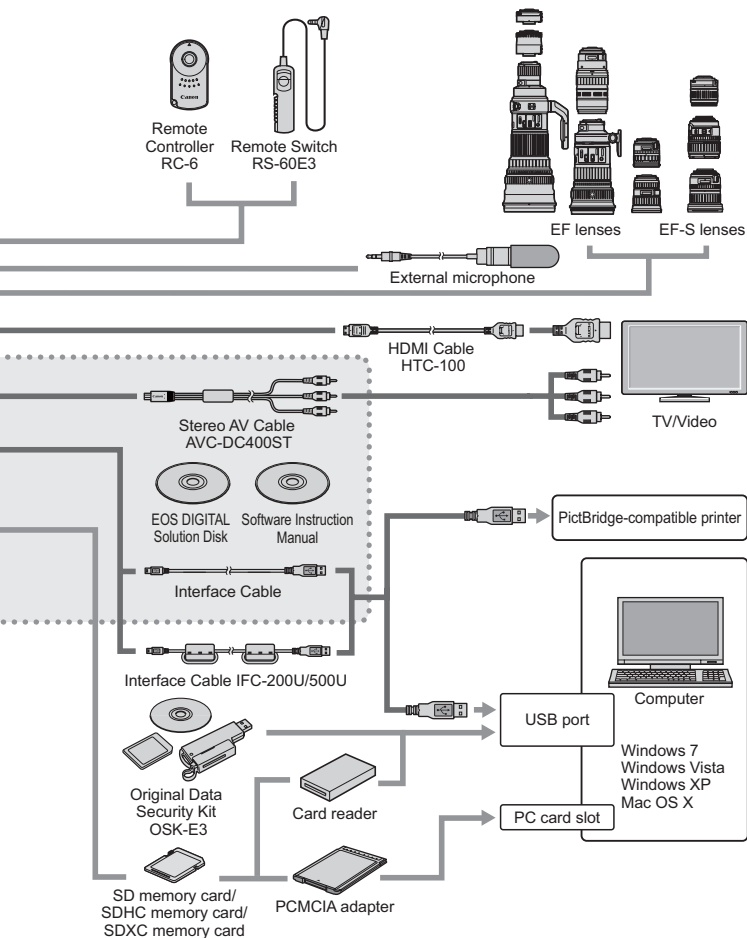

Troubleshooting Guide

If a problem occurs, first refer to this Troubleshooting Guide. If this Troubleshooting Guide does not resolve the problem, contact your dealer or nearest Canon Service Center.

Power-Related Problems

The battery cannot be recharged with the battery charger provided.

- Do not recharge any battery pack other than a genuine Canon Battery Pack LP-E8.

The camera does not operate even when the power switch is set to <ON>.

- The battery is not properly installed in the camera (p.26).
- Recharge the battery (p.24).
- Make sure the battery compartment cover is closed (p.26).
- Make sure the card slot cover is closed (p.31).
- Press the <DISP.> button (p.44).

The battery charger's lamp blinks.

- If there is a problem with the battery charger, the protective circuit will stop the charging operation and the charge lamp will blink in orange. If this happens, disconnect the charger's power plug from the power outlet and remove the battery pack. Attach the battery pack to the charger again and wait a while before connecting the charger to a power outlet again.

The access lamp still blinks even when the power switch is set to <OFF>.

- If the power is cut off while an image is being recorded to the card, the access lamp will still continue to light/blink for a few seconds. When the image recording is completed, the power will turn off automatically.

The battery becomes exhausted quickly.

- Use a fully-charged battery pack (p.24).
- The rechargeable battery pack performance will degrade over repeated use. Purchase a new one.
- If you use Live View shooting or shoot movies for a prolonged period (p.107, 123), the number of possible shots will decrease.

The camera turns off by itself.

- Auto power off is in effect. If you do not want auto power off to take effect, set [**Auto power off**] to [**Off**].
- Even if [**Auto power off**] has been set to [**Off**], the LCD monitor will still turn off after the camera is idle for 30 min. Press the <DISP.> button to turn on the LCD monitor.

Shooting-Related Problems

No images can be shot nor recorded.

- The card is not properly inserted (p.31).
- If the card is full, replace the card or delete unnecessary images to make room (p.31, 171).
- If you try to focus in One-Shot AF mode while the focus confirmation light <●> in the viewfinder blinks, a picture cannot be taken. Press the shutter button halfway again to focus, or focus manually (p.37, 69).
- Slide the card's write-protect switch to the Write/Erase setting (p.31).

The image is out of focus.

- Set the lens focus mode switch to <AF> (p.33).
- To prevent camera shake, press the shutter button gently (p.36, 37).
- If the lens has an Image Stabilizer, set the IS switch to <ON>.

The card cannot be used.

- If a card error message is displayed, see page 42 or 224.

The maximum burst during continuous shooting is lower.

- Set the [**F**: Custom Functions (C.Fn)] menu's [**High ISO speed noise reduction**] to [**Standard**], [**Low**], or [**Disable**]. If it is set to [**Strong**], the maximum burst during continuous shooting will greatly decrease (p.193).
- If you shoot something that has fine detail (field of grass, etc.), the file size will be larger and the actual maximum burst might be lower than the number mentioned on page 72.

ISO 100 cannot be set.

- Under the [**F**: Custom Functions (C.Fn)] menu, if [**Highlight tone priority**] is set to [**Enable**], ISO 100 cannot be set. When [**Highlight tone priority**] is set to [**Disable**], ISO 100 can be set (p.194). This also applies to movie shooting (p.134).

The Auto Lighting Optimizer cannot be set.

- Under the [**F**: Custom Functions (C.Fn)] menu, if [**Highlight tone priority**] is set to [**Enable**], the Auto Lighting Optimizer cannot be set. When [**Highlight tone priority**] is set to [**Disable**], then the Auto Lighting Optimizer can be set (p.194). This also applies to movie shooting (p.134).

When I use the <Av> mode with flash, the shutter speed becomes slow.

- If you shoot at night when the background is dark, the shutter speed becomes slow automatically (slow-sync shooting) so that both the subject and background are properly exposed. If you do not want a slow shutter speed to be set, set the [**F**: Custom Functions (C.Fn)] menu's [**Flash sync. speed in Av mode**] to 1 or 2 (p.192).

The built-in flash does not fire.

- If you shoot continuously with the built-in flash at short intervals, the flash might stop operating to protect the flash unit.

The camera makes a noise when it is shaken.

- The built-in flash's pop-up mechanism moves slightly. This is normal.

The shutter makes two shooting sounds during Live View shooting.

- If you use flash, the shutter will make two sounds each time you shoot (p.109).

The movie shooting terminates by itself.

- If the card's writing speed is slow, movie shooting may stop automatically. Use an SD Speed Class 6 "CLASS 6" or faster card. To find out the card's read/write speed, see the card manufacturer's Web site, etc.
- If the movie file size reaches 4 GB or if the movie recording time reaches 29 min. 59 sec., movie shooting will stop automatically.

When a movie is played, camera operation noise can be heard.

- If you operate the camera's dials or lens during movie shooting, the respective operation noise will also be recorded. Using an external microphone (commercially available) is recommended (p.135).

Display & Operation Problems

The LCD monitor does not display a clear image.

- If the LCD monitor is dirty, use a soft cloth to clean it.
- In low or high temperatures, the LCD monitor display may seem slow or might look black. It will return to normal at room temperature.

The menu screen shows few tabs and options.

- In Basic Zone modes and in movie shooting mode, certain tabs and menu options are not displayed. Set the shooting mode to a Creative Zone mode (p.40).

The image cannot be erased.

- If the image has been protected, it cannot be erased (p.170).

The file name's first character is an underscore (“_MG_”).

- Set the color space to sRGB. If Adobe RGB is set, the first character will be an underscore (p.96).

The file numbering does not start from 0001.

- If you use a card which already has images recorded, the file numbering might start from the last image in the card (p.140).

The shooting date and time displayed is incorrect.

- The correct date and time has not been set (p.29).

No image appears on the TV screen.

- Make sure the AV cable or HDMI cable's plug is inserted all the way in (p.167, 169).
- Set the video OUT system (NTSC/PAL) to the same video system as the TV set (p.214).
- Use the AV cable that came with the camera (p.169).

The card reader does not detect the card.

- Depending on the card reader and computer OS used, SDXC cards might not be correctly detected. In such a case, connect your camera and computer with the provided interface cable, and transfer the images to your computer using EOS Utility (provided software).

The [Eye-Fi Settings] menu item does not appear.

- [Eye-Fi Settings] will only appear when the Eye-Fi card is inserted in the camera. If the Eye-Fi card has a write-protect tab, you will not be able to check the card's connection status, or disable Eye-Fi card transmission when the tab is in the locked position.

Printing-Related Problems**There are fewer printing effects than listed in the instruction manual.**

- What is displayed on the screen differs depending on the printer. This instruction manual lists all the printing effects available (p.180).

Error Codes

Error No.

If there is a problem with the camera, an error message will appear. Follow the on-screen instructions.



Countermeasures

No.	Error Message & Solution
01	Communications between the camera and lens is faulty. Clean the lens contacts.
	→ Clean the electrical contacts on the camera and lens and use a Canon lens (p.13, 16).
02	Card cannot be accessed. Reinsert/change card or format card with camera.
	→ Remove and insert the card again, replace the card, or format the card (p.31, 42).
04	Cannot save images because card is full. Replace card.
	→ Replace the card, erase unnecessary images, or format the card (p.31, 171, 42).
05	The built-in flash could not be raised. Turn the camera off and on again.
	→ Operate the power switch (p.27).
06	Sensor cleaning is not possible. Turn the camera off and on again.
	→ Operate the power switch (p.27).
10, 20, 30, 40, 50, 60, 70, 80	Shooting is not possible due to an error. Turn the camera off and on again or re-install the battery.
	→ Operate the power switch, remove and install the battery pack again, or use a Canon lens (p.27, 26)

* If the error still persists, write down the error No. and contact your nearest Canon Service Center.

Specifications

• Type

Type:	Digital, single-lens reflex, AF/AE camera with built-in flash
Recording media:	SD memory card, SDHC memory card, SDXC memory card
Image sensor size:	22.3 x 14.9 mm
Compatible lenses:	Canon EF lenses (including EF-S lenses) (35mm-equivalent focal length is approx. 1.6 times the lens focal length)
Lens mount:	Canon EF mount

• Image Sensor

Type:	CMOS sensor
Effective pixels:	Approx. 18.00 megapixels
Aspect ratio:	3:2
Dust delete feature:	Auto, Manual, Dust Delete Data appending

• Recording System

Recording format:	Design rule for Camera File System 2.0
Image type:	JPEG, RAW (14-bit Canon original) RAW+JPEG simultaneous recording possible
Recorded pixels:	Large : Approx. 17.90 megapixels (5184 x 3456) Medium : Approx. 8.00 megapixels (3456 x 2304) Small : Approx. 4.50 megapixels (2592 x 1728) RAW : Approx. 17.90 megapixels (5184 x 3456)

• Image Processing

Picture Style:	Standard, Portrait, Landscape, Neutral, Faithful, Monochrome, User Def. 1 - 3
White balance:	Auto, Preset (Daylight, Shade, Cloudy, Tungsten light, White fluorescent light, Flash), Custom White balance correction and white balance bracketing features provided * Color temperature information transmission enabled
Noise reduction:	Applicable to long exposures and high ISO speed shots
Automatic image brightness correction:	Auto Lighting Optimizer
Highlight tone priority:	Provided
Lens peripheral illumination correction:	Provided

• **Viewfinder**

Type:	Eye-level pentamirror
Coverage:	Vertical/Horizontal approx. 95%
Magnification:	Approx. 0.87x (-1 m ⁻¹ with 50mm lens at infinity)
Eye point:	Approx. 19 mm (From eyepiece lens center at -1 m ⁻¹)
Built-in dioptic adjustment:	-3.0 - +1.0 m ⁻¹ (dpt)
Focusing screen:	Fixed, Precision Matte
Mirror:	Quick-return type
Depth-of-field preview:	Provided

• **Autofocus**

Type:	TTL secondary image-registration, phase detection
AF points:	9 AF points
Metering range:	EV -0.5 - 18 (at 23°C/73°F, ISO 100)
Focus modes:	One-Shot AF, AI Servo AF, AI Focus AF, Manual focusing (MF)
AF-assist beam:	Small series of flashes fired by built-in flash

• **Exposure Control**

Metering modes:	63-zone TTL full-aperture metering <ul style="list-style-type: none"> • Evaluative metering (linkable to any AF point) • Partial metering (approx. 9% of viewfinder at center) • Spot metering (approx. 4% of viewfinder at center) • Center-weighted average metering
Metering range:	EV 1 - 20 (at 23°C/73°F with EF50mm f/1.4 USM lens, ISO 100)
Exposure control:	Program AE (Full Auto, Portrait, Landscape, Close-up, Sports, Night Portrait, Flash Off, Creative Auto, Program), shutter-priority AE, aperture-priority AE, depth-of-field AE, manual exposure
ISO speed: (Recommended exposure index)	Basic Zone modes: ISO 100 - 3200 set automatically Creative Zone modes: ISO 100 - 6400 (in whole-stop increments), ISO 100 - 6400 Auto, or ISO speed expanded to ISO 12800
Exposure compensation:	Manual and AEB (Settable in combination with manual exposure compensation) Settable amount: ±5 stops in 1/3- or 1/2-stop increments
AE lock:	Auto: Applied in One-Shot AF mode with evaluative metering when focus is achieved Manual: By AE lock button

• Shutter

Type:	Electronically-controlled, focal-plane shutter
Shutter speeds:	1/4000 sec. to 1/60 sec. (Full Auto mode), X-sync at 1/200 sec. 1/4000 sec. to 30 sec., bulb (Total shutter speed range. Available range varies by shooting mode.)

• Flash

Built-in flash:	Retractable, auto pop-up flash Guide No.: 13/43 (ISO 100, in meters/feet) Flash coverage: 17mm lens angle of view Recycling time approx. 3 sec.
External flash:	EX-series Speedlite (Flash functions settable with the camera)
Flash metering:	E-TTL II autoflash
Flash exposure compensation:	±2 stops in 1/3- or 1/2-stop increments
FE lock:	Provided
PC terminal:	None

• Drive System

Drive mode:	Single shooting, continuous shooting, self-timer with 10-sec. or 2-sec. delay and 10-sec. delay with continuous shooting
Continuous shooting speed:	Max. approx. 3.7 shots/sec.
Max. burst:	JPEG Large/Fine: Approx. 34 shots RAW: Approx. 6 shots RAW+JPEG Large/Fine: Approx. 3 shots * Figures are based on Canon's testing standards (ISO 100 and Standard Picture Style) using a 4GB card.

• Live View Shooting

Focusing:	Live mode, Face detection Live mode (Contrast detection) Quick mode (Phase-difference detection) Manual focusing (5x/10x magnification possible)
Metering modes:	Evaluative metering with the image sensor
Metering range:	EV 0 - 20 (at 23°C/73°F with EF50mm f/1.4 USM lens, ISO 100)
Grid display:	Two types

• **Movie Shooting**

Movie compression:	MPEG-4 AVC/H.264 Variable (average) bit rate
Audio recording format:	Linear PCM
Recording format:	MOV
Recording size and frame rate:	1920x1080 (Full HD) : 30p/25p/24p 1280x720 (HD) : 60p/50p 640x480 (SD) : 60p/50p Crop 640x480 (SD) : 60p/50p * 30p: 29.97 fps, 25p: 25.00 fps, 24p: 23.976 fps, 60p: 59.94 fps, 50p: 50.00 fps
File size:	1920x1080 (30p/25p/24p) : Approx. 330 MB/min. 1280x720 (60p/50p) : Approx. 330 MB/min. 640x480 (60p/50p) : Approx. 165 MB/min. Crop 640x480 (60p/50p) : Approx. 165 MB/min.
Focusing:	Same as focusing with Live View shooting
Metering modes:	Center-weighted average and evaluative metering with the image sensor * Automatically set by the focusing mode
Metering range:	EV 0 - 20 (at 23°C/73°F with EF50mm f/1.4 USM lens, ISO 100)
Exposure control:	Program AE (exposure compensation possible) for movies and manual exposure
ISO speed:	With autoexposure shooting: Automatically set within ISO 100 - 6400 With manual exposure: Manually settable within ISO 100 - 6400 (in whole-stop increments), ISO auto
Sound recording:	Built-in monaural microphone External stereo microphone terminal provided
Grid display:	Two types

• **LCD Monitor**

Type:	TFT color liquid-crystal monitor
Monitor size and dots:	3.0-in. with approx. 1.04 million dots
Coverage:	Approx. 100%
Brightness adjustment:	Manual (7 levels)
Interface language:	25

• Image Playback

Image display formats:	Single image, Single image + Info (Basic info, detailed info, histogram), 4-image index, 9-image index, image rotate possible
Zoom magnification:	Approx. 1.5x - 10x
Image browsing methods:	Single image, jump by 10 or 100 images, by shooting date, by movie, by stills
Highlight alert:	Overexposed highlights blink
Movie playback:	Enabled (LCD monitor, video/audio OUT, HDMI OUT) Built-in speaker

• Direct Printing

Compatible printers:	PictBridge-compatible printers
Printable images:	JPEG and RAW images
Print ordering:	DPOF Version 1.1 compatible

• Custom Functions

Custom Functions:	12
My Menu registration:	Provided
Copyright information:	Entry and inclusion possible

• Interface

Audio/video OUT/	
Digital terminal:	Analog video (Compatible with NTSC/PAL)/stereo audio output For personal computer communication and direct printing (Hi-Speed USB equivalent)
HDMI mini OUT terminal:	Type C (Auto switching of resolution), CEC-compatible
External microphone	
IN terminal:	3.5mm dia. stereo mini-jack
Remote control terminal:	For Remote Switch RS-60E3
Wireless remote control:	Remote Controller RC-6

• Power Source

Battery:	Battery Pack LP-E8 (Quantity 1) * AC power can be supplied via AC Adapter Kit ACK-E8 * With Battery Grip BG-E8 attached, size-AA/LR6 batteries can be used
Battery life:	With viewfinder shooting: Approx. 440 shots at 23°C/73°F, approx. 400 shots at 0°C/32°F With Live View shooting: Approx. 180 shots at 23°C/73°F, approx. 150 shots at 0°C/32°F
(Based on CIPA testing standards)	

• Dimensions and Weight

Dimensions (W x H x D): 128.8 x 97.5 x 75.3 mm / 5.1 x 3.8 x 3.0 in.

Weight: Approx. 530 g / 18.7 oz. (CIPA testing standards)
Approx. 475 g / 16.8 oz. (body only)

• Operation Environment

Working temperature range: 0°C - 40°C / 32°F - 104°F

Working humidity: 85% or less

• Battery Pack LP-E8

Type: Rechargeable lithium-ion battery

Rated voltage: 7.2 V DC

Battery capacity: 1120 mAh

Working temperature range: During charging: 6°C - 40°C / 43°F - 104°F

During shooting: 0°C - 40°C / 32°F - 104°F

Working humidity: 85% or less

Dimensions (W x H x D): 37.1 x 15.4 x 55.2 mm / 1.5 x 0.6 x 2.2 in.

Weight: Approx. 52 g / 1.8 oz.

• Battery Charger LC-E8

Compatible battery: Battery Pack LP-E8

Recharging time: Approx. 2 hours (at 23°C / 73°F)

Rated input: 100 - 240 V AC (50/60 Hz)

Rated output: 8.4 V DC / 720mA

Working temperature range: 6°C - 40°C / 43°F - 104°F

Working humidity: 85% or less

Dimensions (W x H x D): 69 x 28 x 87.5 mm / 2.7 x 1.1 x 3.4 in.

Weight: Approx. 82 g / 2.9 oz.

• Battery Charger LC-E8E

Compatible battery: Battery Pack LP-E8

Recharging time: Approx. 2 hours (at 23°C / 73°F)

Rated input: 100 - 240 V AC (50/60 Hz)

Rated output: 8.4 V DC / 720mA

Working temperature range: 6°C - 40°C / 43°F - 104°F

Working humidity: 85% or less

Dimensions (W x H x D): 69 x 28 x 87.5 mm / 2.7 x 1.1 x 3.4 in.

Weight: Approx. 82 g / 2.9 oz.

• EF-S18-55mm f/3.5-5.6 IS II

Angle of view:	Diagonal extent: 74°20' - 27°50' Horizontal extent: 64°30' - 23°20' Vertical extent: 45°30' - 15°40'
Lens construction:	11 elements in 9 groups
Minimum aperture:	f/22 - 36
Closest focusing distance:	0.25 m / 0.82 ft. (From image sensor plane)
Max. magnification:	0.34x (at 55 mm)
Field of view:	207 x 134 - 67 x 45 mm / 8.1 x 5.3 - 2.6 x 1.8 in. (at 0.25 m / 0.82 ft.)
Image Stabilizer:	Lens shift type
Filter size:	58 mm
Lens cap:	E-58
Max. diameter x length:	68.5 x 70 mm / 2.7 x 2.8 in.
Weight:	Approx. 200 g / 7.1 oz.
Hood:	EW-60C (sold separately)
Case:	LP814 (sold separately)

• EF-S18-135mm f/3.5-5.6 IS

Angle of view:	Diagonal extent: 74°20' - 11°30' Horizontal extent: 64°30' - 9°30' Vertical extent: 45°30' - 6°20'
Lens construction:	16 elements in 12 groups
Minimum aperture:	f/22 - 36
Closest focusing distance*:	At 18mm focal length: 0.49 m / 1.61 ft. (327 x 503 mm / 12.9 x 19.8 in. field of view) At 135mm focal length: 0.45 m / 1.48 ft. (75 x 112 mm / 3.0 x 4.4 in. field of view) * Distance from image sensor plane
Max. magnification:	0.21x (at 135mm)
Image Stabilizer:	Lens shift type
Filter size:	67 mm
Lens cap:	E-67U
Max. diameter x length:	75.4 x 101 mm / 3.0 x 4.0 in.
Weight:	Approx. 455 g / 16.0 oz.
Hood:	EW-73B (sold separately)
Case:	LP1116 (sold separately)

- All specifications above are based on Canon's testing standards.
- Product specifications and the exterior are subject to change without notice.
- If a problem occurs with a non-Canon lens attached to the camera, consult the respective lens maker.

Trademarks

- Adobe is a trademark of Adobe Systems Incorporated.
 - Windows is a trademark or registered trademark of Microsoft Corporation in the United States and other countries.
 - Macintosh and Mac OS are trademarks or registered trademarks of Apple Inc. in the United States and other countries.
 - SDXC logo is a trademark of SD-3C, LLC.
 - HDMI, HDMI logo, and High-Definition Multimedia Interface are a trademark or registered trademark of HDMI Licensing LLC.
 - All other corporate and product names and trademarks mentioned in this manual are the property of their respective owners.
- * This digital camera supports Design rule for Camera File System 2.0 and Exif 2.21 (also called "Exif Print"). Exif Print is a standard that enhances compatibility between digital cameras and printers. By connecting the camera to an Exif Print-compliant printer, the shooting information is incorporated to optimize the print output.

About MPEG-4 Licensing

"This product is licensed under AT&T patents for the MPEG-4 standard and may be used for encoding MPEG-4 compliant video and/or decoding MPEG-4 compliant video that was encoded only (1) for a personal and non-commercial purpose or (2) by a video provider licensed under the AT&T patents to provide MPEG-4 compliant video. No license is granted or implied for any other use for MPEG-4 standard."

* Notice displayed in English as required.

Use of genuine Canon accessories is recommended

This product is designed to achieve excellent performance when used with genuine Canon accessories. Canon shall not be liable for any damage to this product and/or accidents such as fire, etc., caused by the malfunction of non-genuine Canon accessories (e.g., a leakage and/or explosion of a battery pack). Please note that this warranty does not apply to repairs arising out of the malfunction of non-genuine Canon accessories, although you may request such repairs on a chargeable basis.

Safety Warnings

Follow these safeguards and use the equipment properly to prevent injury, death, and material damage.

Preventing Serious Injury or Death

- To prevent fire, excessive heat, chemical leakage, and explosions, follow the safeguards below:
 - Do not use any batteries, power sources, and accessories not specified in this booklet. Do not use any home-made or modified batteries.
 - Do not short-circuit, disassemble, or modify the battery pack or back-up battery. Do not apply heat or apply solder to the battery pack or back-up battery. Do not expose the battery pack or back-up battery to fire or water. And do not subject the battery pack or back-up battery to strong physical shock.
 - Do not install the battery pack or back-up battery in reversed polarity (+ -). Do not mix new and old or different types of batteries.
 - Do not recharge the battery pack outside the allowable ambient temperature range of 0°C - 40°C (32°F - 104°F). Also, do not exceed the recharging time.
 - Do not insert any foreign metallic objects into the electrical contacts of the camera, accessories, connecting cables, etc.
- Keep the back-up battery away from children. If a child swallows the battery, consult a physician immediately. (Battery chemicals may harm the stomach and intestines.)
- When disposing of a battery pack or back-up battery, insulate the electrical contacts with tape to prevent contact with other metallic objects or batteries. This is to prevent fire or an explosion.
- If excessive heat, smoke, or fumes are emitted during battery pack recharging, immediately unplug the battery charger from the power outlet to stop the recharging and prevent a fire.
- If the battery pack or back-up battery leaks, changes color, deforms, or emits smoke or fumes, remove it immediately. Be careful not to get burned in the process.
- Prevent any battery leakage from contacting your eyes, skin, and clothing. It can cause blindness or skin problems. If the battery leakage contacts your eyes, skin, or clothing, flush the affected area with lots of clean water without rubbing it. See a physician immediately.
- During the recharging, keep the equipment away from the reach of children. The cord can accidentally choke the child or give an electrical shock.
- Do not leave any cords near a heat source. It can deform the cord or melt the insulation and cause a fire or electrical shock.
- Do not fire the flash at someone driving a car. It may cause an accident.
- Do not fire the flash near a person's eyes. It may impair the person's vision. When using flash to photograph an infant, keep at least 1 meter away.
- Before storing the camera or accessory when not in use, remove the battery pack and disconnect the power plug. This is to prevent electrical shock, heat generation, and fire.
- Do not use the equipment where there is flammable gas. This is to prevent an explosion or fire.

-
- If you drop the equipment and the casing breaks open to expose the internal parts, do not touch the internal parts due to the possibility of electrical shock.
 - Do not disassemble or modify the equipment. High-voltage internal parts can cause electrical shock.
 - Do not look at the sun or an extremely bright light source through the camera or lens. Doing so may damage your vision.
 - Keep the camera from the reach of small children. The neck strap can accidentally choke the child.
 - Do not store the equipment in dusty or humid places. This is to prevent fire and electrical shock.
 - Before using the camera inside an airplane or hospital, check if it is allowed. Electromagnetic waves emitted by the camera may interfere with the plane's instruments or the hospital's medical equipment.
 - To prevent fire and electrical shock, follow the safeguards below:
 - Always insert the power plug all the way in.
 - Do not handle a power plug with wet hands.
 - When unplugging a power plug, grasp and pull the plug instead of the cord.
 - Do not scratch, cut, or excessively bend the cord or put a heavy object on the cord. Also do not twist or tie the cords.
 - Do not connect too many power plugs to the same power outlet.
 - Do not use a cord whose insulation has been damaged.
 - Occasionally unplug the power plug and use a dry cloth to clean off the dust around the power outlet. If the surrounding is dusty, humid, or oily, the dust on the power outlet may become moist and short-circuit the outlet to cause a fire.
-

Preventing Injury or Equipment Damage

-
- Do not leave equipment inside a car under the hot sun or near a heat source. The equipment may become hot and cause skin burns.
 - Do not carry the camera around while it is attached to a tripod. Doing so may cause injury. Also make sure the tripod is sturdy enough to support the camera and lens.
 - Do not leave a lens or lens-attached camera under the sun without the lens cap attached. Otherwise, the lens may concentrate the sun's rays and cause a fire.
 - Do not cover or wrap the battery-recharging apparatus with a cloth. Doing so may trap heat within and cause the casing to deform or catch fire.
 - If you drop the camera in water or if water or metal fragments enter inside the camera, promptly remove the battery pack and back-up battery. This is to prevent fire and electrical shock.
 - Do not use or leave the battery pack or back-up battery in a hot environment. Doing so may cause battery leakage or a shorter battery life. The battery pack or back-up battery can also become hot and cause skin burns.
 - Do not use paint thinner, benzene, or other organic solvents to clean the equipment. Doing so may cause fire or a health hazard.
-

If the product does not work properly or requires repair, contact your dealer or your nearest Canon Service Center.

Digital Camera Model DS126271 Systems

This device complies with Part 15 of the FCC Rules. Operation is subject to the following two conditions: (1) This device may not cause harmful interference, and (2) this device must accept any interference received, including interference that may cause undesired operation.

Note: This equipment has been tested and found to comply with the limits for class B digital devices, pursuant to Part 15 of the FCC Rules. These limits are designed to provide reasonable protection against harmful interference in a residential installation. This equipment generates, uses and can radiate radio frequency energy and, if not installed and used in accordance with the instructions, may cause harmful interference to radio communications. However, there is no guarantee that interference will not occur in a particular installation. If this equipment does cause harmful interference to radio or television reception, which can be determined by turning the equipment off and on, the user is encouraged to try to correct the interference by one or more of the following measures:

- Reorient or relocate the receiving antenna.
- Increase the separation between the equipment and receiver.
- Connect the equipment into an outlet on a circuit different from that to which the receiver is connected.
- Consult the dealer or an experienced radio/TV technician for help.

The cable with the ferrite core provided with the digital camera must be used with this equipment in order to comply with Class B limits in Subpart B of Part 15 of the FCC rules.

Do not make any changes or modifications to the equipment unless otherwise specified in the manual. If such changes or modifications should be made, you could be required to stop operation of the equipment.

Canon U.S.A. Inc.
One Canon Plaza, Lake Success, NY 11042, U.S.A.
Tel No. (516)328-5600

This Class B digital apparatus complies with Canadian ICES-003.



When connecting to and using a household power outlet, use only AC Adapter Kit ACK-E8 (rated input: 100-240 V AC 50/60 Hz, rated output: 7.4 V DC). Using anything else can cause fire, overheating, or electrical shock.

IMPORTANT SAFETY INSTRUCTIONS

1. **SAVE THESE INSTRUCTIONS** — This manual contains important safety and operating instructions for Battery Charger LC-E8 & LC-E8E.
2. Before using the charger, read all instructions and cautionary remarks on (1) the charger, (2) the battery pack, and (3) the product using the battery pack.
3. **CAUTION** — To reduce risk of injury, charge only the Battery Pack LP-E8. Other types of batteries may burst, causing personal injury and other damage.
4. Do not expose the charger to rain or snow.
5. Use of an attachment not recommended or sold by Canon may result in fire, electric shock, or personal injury.
6. To reduce risk of damage to electric plug and cord, pull by plug rather than by cord when disconnecting charger.
7. Make sure cord is located so that it will not be stepped on, tripped over, or otherwise subjected to damage or stress.
8. Do not operate the charger with damaged cord or plug - replace them immediately.
9. Do not operate the charger if it has received a sharp blow, been dropped, or otherwise damaged in any way; take it to a qualified serviceman.
10. Do not disassemble the charger; take it to a qualified serviceman when service or repair is required. Incorrect reassembly may result in a risk of electric shock or fire.
11. To reduce risk of electric shock, unplug charger from outlet before attempting any maintenance or cleaning.

MAINTENANCE INSTRUCTION

Unless otherwise stated in this manual, there are no user serviceable parts inside. Refer servicing to qualified serviceman.



USA and Canada only:

The Lithium ion/polymer battery that powers the product is recyclable. Please call 1-800-8-BATTERY for information on how to recycle this battery.

For CA, USA only

Included lithium battery contains Perchlorate Material – special handling may apply. See www.dtsc.ca.gov/hazardouswaste/perchlorate/ for details.

CAUTION

RISK OF EXPLOSION IF BATTERY IS REPLACED BY AN INCORRECT TYPE.
DISPOSE OF USED BATTERIES ACCORDING TO LOCAL REGULATION.

Index

1280x720	131
1920x1080	131
1st-curtain sync	148
2nd-curtain sync	148
2-sec. self-timer	71
4- or 9-image index display	156
640x480	131

A

A/V OUT	160, 169
Access lamp	32
A-DEP (Automatic depth-of-field AE)	85
Adobe RGB	96
AE lock	97, 112, 134
AEB	89
AF → Focusing	
AI FOCUS (AI Focus AF)	67
AI SERVO (AI Servo AF)	67
AI Servo AF	67
Aperture-priority AE	80
Audio/video OUT	160, 169
Auto Lighting Optimizer	45, 103
Auto playback → Slide show	
Auto power off	27, 139
Autofocus → Focusing	
Av (Aperture-priority AE)	80

B

B/W (Monochrome)	76
Basic Zone modes	20
Battery → Power	

Battery Grip	216
Beeper	138
Black-and-white image	76, 93
Built-in flash	64, 79, 82
Bulb	84
BULB (Bulb exposure)	84

C

 (Creative Auto)	55
Cable	3, 160, 167, 169
Camera	
Camera shake	106
Clear settings	144
Holding the camera	36
Settings display	143
Camera shake	35 - 37
Card	2, 13, 31
Card reminder	31, 138
Eye-Fi	208
Format	42
Problem	32, 224
SD speed class	123
SDHC/SDXC	2
Center-weighted average metering	86
Cleaning (image sensor)	150
Clock → Date/Time	
Close-up	52
Color space	96
Color temperature	99
Color tone	92
Continuous shooting	70
Contrast	92

- Copyright information..... 199
- Creative Auto 55
- Creative Zone modes 20
- Custom Functions 190
- Clear all 190
- List..... 191
- D**
- Date/Time 29
- DC coupler..... 203
- Depth-of-field preview 82
- Dial..... 16, 77
- Digital terminal 176
- Dioptric adjustment 36
- Direct printing → Printing
- DPOF..... 185
- Drive mode 70, 71
- Dust Delete Data 151
- E**
- Erase (image) 171
- Error codes 224
- Evaluative metering 86
- Exposure compensation 87
- Extension 141
- External Speedlite..... 147, 206
- Eye-Fi card 208
- Eyepiece cover 23, 205
- F**
- Face detection Live mode (AF)..... 114
- Faithful 76
- FE lock..... 98
- File number 140
- File size 72, 132, 173
- Filter effect (Monochrome)..... 93
- Firmware Ver. 214
- Flash 64
- 2nd-curtain sync 148
- Built-in flash 64
- Custom Functions 149
- Effective range 64
- External Speedlite..... 147, 206
- FE lock..... 98
- Flash exposure compensation... 88
- Flash off 49, 56
- Flash-sync speed..... 192
- Menu setting 147
- Red-eye reduction 65
- Flash exposure compensation 88
- Focus confirmation light 46
- Focus lock 48
- Focus mode switch 33, 69
- Focusing
- AF mode 66, 113
- AF point selection 68
- AF-assist beam..... 47, 194
- Beeper 138
- Difficult-to-focus subjects .. 117, 202
- Manual focusing..... 69, 120
- Out of focus 47, 117, 202
- Recompose..... 48
- Format (card initialization)..... 42
- Frame rate..... 131
- Full Auto 46
- Full HD 123, 131
- Full High-Definition..... 131, 160

Function availability table210

G

Grid display112, 134

H

HDMI160, 167

HDMI CEC

(High-Definition Multimedia Interface
Consumer Electronics Control).... 168

High-Definition131, 160, 167

Highlight alert173

Highlight detail loss173

Highlight tone priority62, 194

Histogram (Brightness/RGB)174

Household power203

I

ICC profile96

Image

Auto playback165

Erase171

Highlight alert173

Histogram174

Index156

Jump display

(Image browsing).....157

Magnified view158

Playback58, 155

Protect170

Rotate142, 159

Shooting information.....110, 173

View on TV160, 167

Image area34

Image dust prevention151

Image review time138

Image verification data197

Image Zone20

Image-recording quality72

Index display156

ISO speed62

Auto63

ISO expansion192

Maximum ISO speed

with Auto ISO63

J

JPEG72

Jump display157

L

Landscape51, 75

Language selection30

LCD monitor13

Auto off146

Brightness adjustment139

Display switching44

Image playback58, 155

Menu screen40

Screen color146

Shooting settings display18

Lens21, 33 - 35

Attaching/Detaching33

Lens peripheral illumination

correction104

Live mode (AF)113

Live View shooting	107
Focusing	113
Grid display	112
Possible shots	109

Long exposures → Bulb

Low level format	42, 43
------------------------	--------

M

M (Manual exposure)	83
Magnified view	120, 158
Malfunction	218
Manual exposure	83, 127
Manual focusing	69, 120
Maximum burst	73
Memory card → Card	
Menu	

Menu settings	212
My Menu	198
Setting operation	40

Metering mode	86
Metering timer	112, 134
MF (Manual focusing)	69, 120
Microphone	134
Mirror lockup	106, 195
Mode Dial	20
Monochrome	76

Movie

Autoexposure shooting	124
Editing out first and last scenes	164
Enjoying	160
File size	132
Frame rate	131
Manual exposure shooting	127
Movie crop	131
Playback	162
Recording size	131
Recording time	132
Shooting	123
Sound recording	134
Still photo shooting	129
View on TV	160, 167
My Menu	198

N

Neutral	76
Night Portrait	54
Night scene	51
Noise reduction	
High ISO speed	70, 74, 193
Long exposure	84, 193
Nomenclature	16 - 22
NTSC	131, 214

O

ONE SHOT (One-Shot AF)	66
One-Shot AF	66

P

P (Program AE)	60
PAL	131, 214

Paper settings (printing).....	178
Partial metering.....	86
Peripheral illumination correction ...	104
PictBridge.....	175
Picture Style	
Adjustment.....	91
Selection.....	75
User defined	94
Pixels	72
Playback	58, 155
Portrait	50, 54, 75
Possible shots.....	28, 109
Power	
Auto power off	27, 139
Battery check.....	28
Household power.....	203
Possible shots	28, 109
Recharge	24
Switch.....	27
Printing.....	176
Page layout.....	179
Paper settings.....	179
Print Order (DPOF).....	185
Printing effects.....	180, 182
Tilt correction	183
Trimming.....	183
Program AE	60
Program shift	61
Protect (image erase-protection) ...	170

Q









Q (Quick Control).....	38
Quick Control screen	38
Quick mode (AF).....	118

R

RAW	72 - 74
RAW+JPEG.....	72 - 74
Recharge.....	24
Red-eye reduction	65
Release shutter without card.....	31
Remote control	
shooting.....	57, 71, 133, 204
Revert to default settings.....	144
Rotate (image).....	142, 159

S

Safety warnings.....	233
Saturation.....	92
SD/SDHC/SDXC card → Card	
Self-timer	71
Sensor cleaning.....	27, 150, 153
Sepia (Monochrome).....	93
Sharpness	92
Shooting information	
display	110, 126, 173

Shooting mode.....	20
A-DEP	
(Automatic depth-of-field AE)	85
M (Manual exposure)	83
Av (Aperture-priority AE)	80
Tv (Shutter-priority AE).....	78
P (Program AE)	60
 (Creative Auto)	55
 (Full Auto).....	46
 (Flash Off)	49
 (Portrait)	50
 (Landscape)	51
 (Close-up)	52
 (Sports).....	53
 (Night Portrait).....	54
 (Movie shooting).....	123
Shooting settings display	18
Shutter button	37
Shutter-priority AE	78
Slide show	165
Sound recording	134
Speaker.....	162
Sports.....	53
Spot metering.....	86
sRGB	96
Standard	75
Stopped-down aperture	82
Strap	23
System map.....	216

T

Tone priority	194
Toning effect (Monochrome).....	93
Trimming (printing).....	183

Tv (Shutter-priority AE)	78
--------------------------------	----

V





Video system.....	169, 214
View on TV.....	160, 167
Viewfinder	19
Dioptic adjustment	36
Volume (Movie playback).....	163

W

WB → White balance	
White balance	99
Bracketing	102
Correction	101
Custom	99
Personal.....	100

EOS *REBEL T2i* EOS 550D

Quick Reference Guide

Menu Operations - - - - -	p.244
 Quick Control Screen - - - - -	p.245
Image-recording Quality - - - - -	p.246
Picture Style - - - - -	p.246
Nomenclature - - - - -	p.247
Basic Zone Modes - - - - -	p.249
Using the Built-in Flash - - - - -	p.249
Creative Zone Modes - - - - -	p.250
P : Program AE - - - - -	p.250
Tv : Shutter-priority AE - - - - -	p.250
Av : Aperture-priority AE - - - - -	p.250
AF: AF Mode - - - - -	p.251
 AF Point - - - - -	p.251
ISO: ISO Speed - - - - -	p.252
 Drive Mode - - - - -	p.252
 Live View Shooting - - - - -	p.253
 Shooting Movies - - - - -	p.254
Custom Functions - - - - -	p.254
Image Playback - - - - -	p.255

Software Start Guide

EOS DIGITAL Solution Disk - - - - -	p.256
Installing the Software - - - - -	p.257
Software Instruction Manual - - - - -	p.258

Quick Reference Guide

Menu Operations

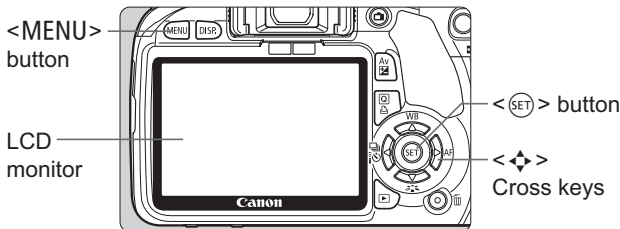

1. Press the <MENU> button to display the menu.
2. Press the <◀▶> key to select the tab, then press the <▲▼> key to select the desired item.
3. Press <SET> to display the setting.
4. After setting the item, press <SET>.

Basic Zone Modes



Movie Shooting Mode

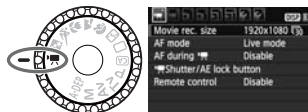

Creative Zone Modes

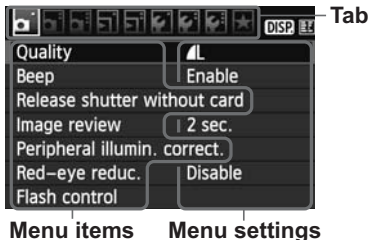
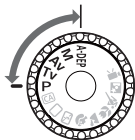

Q Quick Control Screen

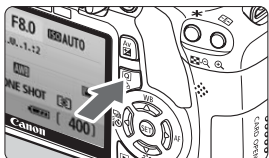

- With the shooting settings displayed, press the **<Q>** button.
- ▶ The Quick Control screen will appear.

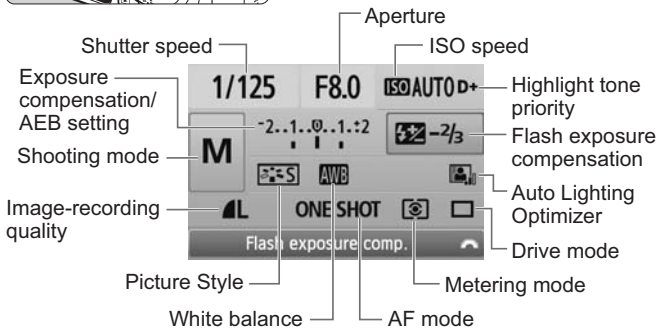

- Press the **<Q>** key to select the function, then turn the **<Q>** dial to set it.
- In the Basic Zone modes (except **CA**), you can select certain drive modes and the image-recording quality.

Image-recording Quality

- Select [**Quality**], then press <SET>.
- Press the <◀▶> key to select the quality, then press <SET>.

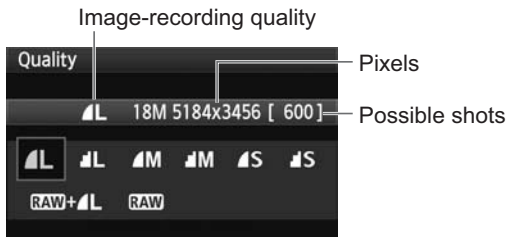

Picture Style ☆

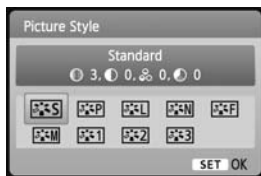

- Press the <▼ > button.
- Press the <◀▶> key to select the Picture Style, then press <SET>.

Style	Description
Standard	Vivid colors and sharp images.
Portrait	Nice skin tones and slightly sharp images.
Landscape	Vivid blue skies and greenery and very sharp images.
Monochrome	Black-and-white images.

- For < > (Neutral) and < > (Faithful), see page 76.

Nomenclature

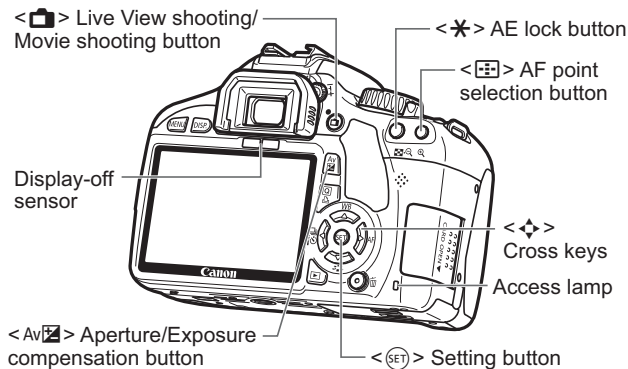
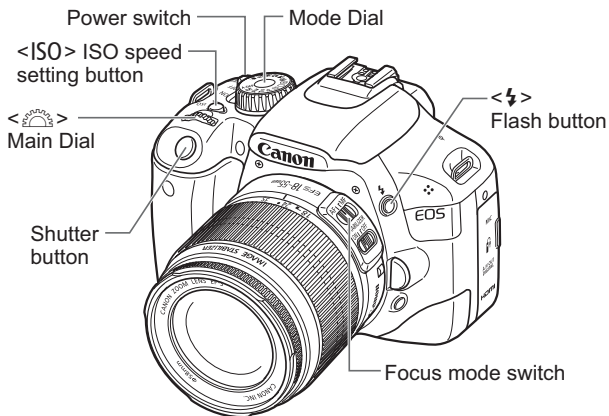

Shooting Settings Display

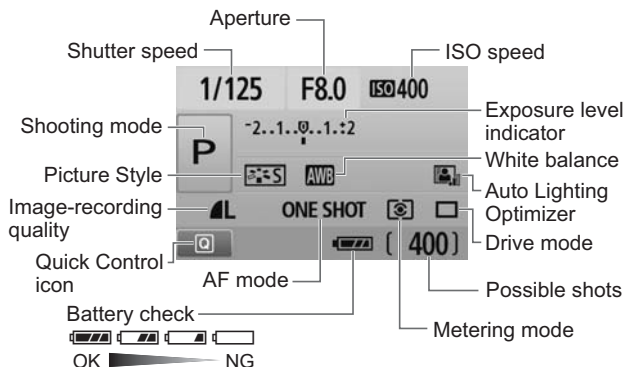

Viewfinder Information

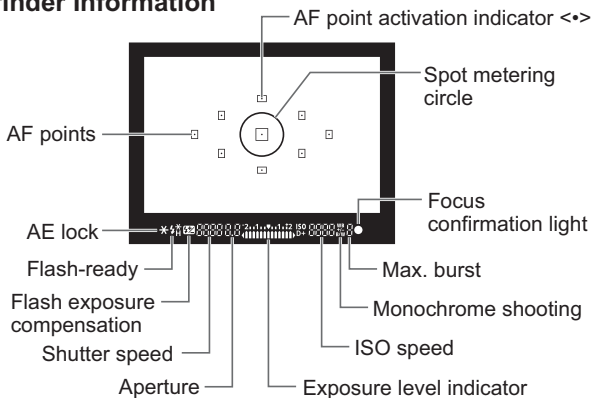

Basic Zone Modes



All the settings necessary for shooting are set automatically. You just press the shutter button, and the camera does the rest.

- Full Auto
- Creative Auto
- Flash Off
- Portrait
- Landscape
- Close-up
- Sports
- Night Portrait



(Displayed only when $\langle \text{CA} \rangle$ is set.)

- Press the $\langle \text{Q} \rangle$ button, then press the $\langle \text{Fn} \rangle$ key to select the function.
- Turn the $\langle \text{Mode Dial} \rangle$ to set the function.

⚡ Using the Built-in Flash

Basic Zone Modes

If necessary, the built-in flash will pop-up automatically in low-light or backlit conditions (except in the $\langle \text{Flash Off} \rangle$ $\langle \text{Landscape} \rangle$ $\langle \text{Sports} \rangle$ modes).

Creative Zone Modes

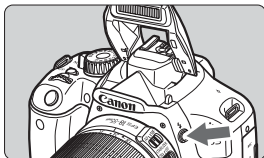

- Press the $\langle \text{Flash} \rangle$ button to pop up the built-in flash, then shoot.

Creative Zone Modes

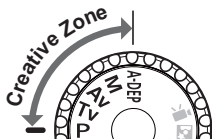

You can change the camera settings as desired to shoot in various ways.

P: Program AE

The camera automatically sets the shutter speed and aperture in the same way as the <□> mode.

- Set the Mode Dial to <P>.

Tv: Shutter-priority AE



1/125 F8.0 ISO 400

- Set the Mode Dial to <Tv>.
- Turn the <☀> dial to set the desired shutter speed, then focus the subject.
- ▶ The aperture will be set automatically.
- If the aperture display blinks, turn the <☀> dial until it stops blinking.

Av: Aperture-priority AE



1/125 F8.0 ISO 400

- Set the Mode Dial to <Av>.
- Turn the <☀> dial to set the desired aperture, then focus the subject.
- ▶ The shutter speed will be set automatically.
- If the shutter speed display blinks, turn the <☀> dial until it stops blinking.

AF: AF Mode ☆

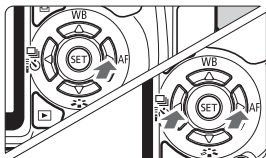

- Set the lens focus mode switch to **<AF>**.
- Press the **<▶ AF>** button.
- Press the **<◀▶>** key to select the AF mode, then press **<SET>**.

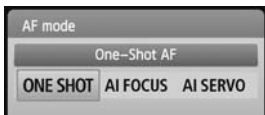

ONE SHOT (One-Shot AF):

For still subjects

AI FOCUS (AI Focus AF):

Switches the AF mode automatically

AI SERVO (AI Servo AF):

For moving subjects

AF Point ☆

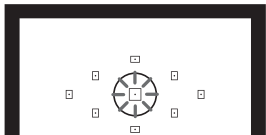
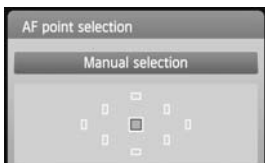

- Press the **<AF-ON>** button.
- Press the **<◀▶>** key to select the AF point.
- While looking at the viewfinder, you can select the AF point by turning the **<◀▶>** dial until the desired AF point flashes in red.
- Pressing **<SET>** toggles the AF point selection between the center AF point and automatic AF point selection.

ISO: ISO Speed ☆

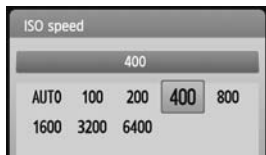
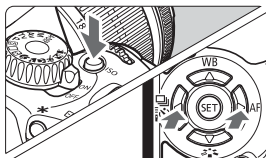

- Press the <ISO> button.
- Turn the <WB/ISO> dial or press the <◀▶> key to select the ISO speed.
- When “**AUTO**” is selected, the ISO speed is set automatically. When you press the shutter button halfway, the ISO speed setting will be displayed.

Drive Mode ☆

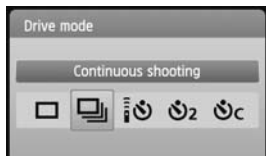
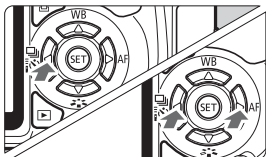

- Press the <◀[Drive Mode] [Self-timer/Remote control]> button.
- Press the <◀▶> key to select the drive mode, then press <SET>.

□ : **Single shooting**

[Stack of squares] : **Continuous shooting**

[Timer icon] : **Self-timer/Remote control***

[Timer icon with 2] : **Self-timer:2 sec**

[Timer icon with C] : **Self-timer:Continuous***

* The <[Timer icon]> and <[Timer icon with C]> drive modes can be selected in all shooting modes.

Live View Shooting



- Press the  button to display the Live View image.



- Press the shutter button halfway to focus.

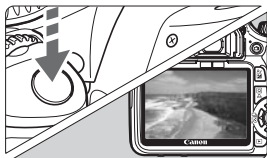

- Press the shutter button completely to take the picture.

- To change the Live View settings, use the [ **Live View function settings**] menu.
- **Battery Life with Live View Shooting**

Temperature	No Flash	50% Flash Use
At 23°C / 73°F	Approx. 200 shots	Approx. 180 shots

Shooting Movies



- Set the Mode Dial to .



- Press the shutter button halfway to focus.
- Press the button to start shooting a movie. To stop movie shooting, press again.
- To shoot still photos, press the shutter button.

Custom Functions ☆

1	Exposure level increments	7	AF-assist beam firing
2	ISO expansion	8	Mirror lockup
3	Flash sync. speed in Av mode	9	Shutter/AE lock button
4	Long exposure noise reduction	10	Assign SET button
5	High ISO speed noise reduction	11	LCD display when power ON
6	Highlight tone priority	12	Add image verification data

Image Playback

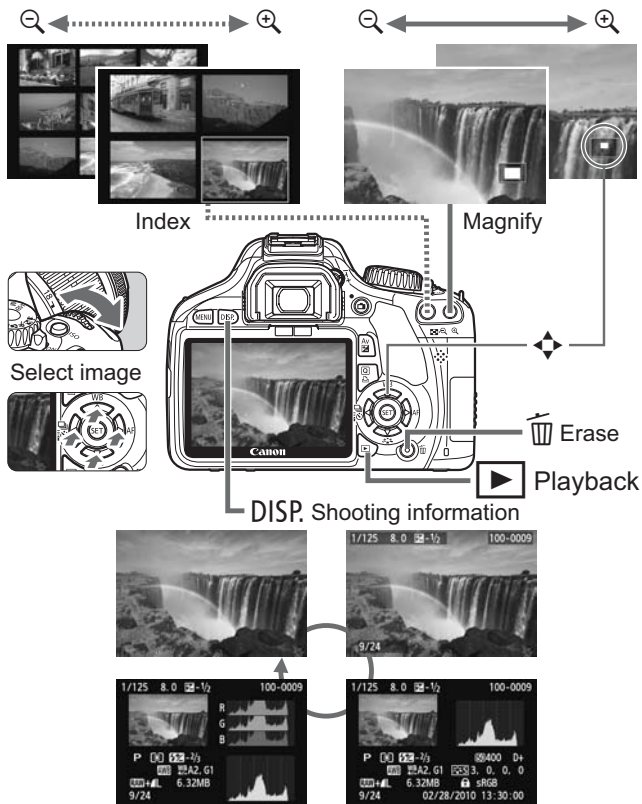

Software Start Guide



EOS DIGITAL Solution Disk

This disk contains various software for EOS DIGITAL.

EOS Utility

Software that lets you connect your computer and camera in order to download images (still images/movies) shot with the camera to the computer, set various settings of the camera, and remotely shoot photos by operating the computer.

Digital Photo Professional

This software is recommended for users who mainly shoot RAW images. You can view/edit/process/print RAW images at high speed. You can also edit JPEG images while retaining the original images.

ZoomBrowser EX (Win) / ImageBrowser (Mac)

This software is recommended for users who mainly shoot JPEG images. You can easily view/edit/organize/sort/print JPEG images. You can also play/edit MOV movies and extract still images from movies.

Picture Style Editor

This software is aimed at advanced users who are experienced in editing images. The software edits Picture Styles and you can create/save original Picture Style files.

Installing the Software

- Never connect the camera to your computer before you install the software. The software will not be installed correctly.
- Even if the previous version of the software is installed, install the software by following the steps below (the current software will overwrite the previous version).

1 Insert EOS DIGITAL Solution Disk (CD).

- For Macintosh, double-click to open the CD-ROM icon displayed on the desktop, and double-click on [Canon EOS Digital Installer].

2 Click [Easy Installation] and follow the instructions on the screen to install.

- For Macintosh, click [Install].



3 Click [Restart] and remove the CD once the computer restarts.

- When the computer has restarted, the installation is complete.



Software Instruction Manual

Contains the Instruction Manual files for the software provided.

Copying and Viewing the Instruction Manual PDFs

1 Insert the [Software INSTRUCTION MANUAL] CD into your computer.

2 Double-click the CD-ROM icon.

- For Windows, it is the icon displayed in [My Computer].
- For Macintosh, it is the icon displayed on the desktop.

3 Copy the [English] folder to your computer.

- Instruction Manual PDFs with the following names are copied.

	Windows	Macintosh
EOS Utility	EUx.xW_E_xx	EUx.xM_E_xx
Digital Photo Professional	DPPx.xW_E_xx	DPPx.xM_E_xx
ZoomBrowser EX / ImageBrowser	ZBx.xW_E_xx	IBx.xM_E_xx
Picture Style Editor	PSEx.xW_E_xx	PSEx.xM_E_xx

4 Double-click the copied PDF file.

- Adobe Reader (Version 6.0 or later) must be installed in your computer.
- Adobe Reader can be downloaded free from the Internet.





CANON INC. 30-2, Shimomaruko 3-chome, Ohta-ku, Tokyo 146-8501, Japan

U.S.A. ————— **CANON U.S.A. INC.**

One Canon Plaza, Lake Success, NY 11042-1198, U.S.A.
For all inquiries concerning this product, call toll free in the U.S.
1-800-OK-CANON

CANADA ————— **CANON CANADA INC. HEADQUARTERS**

6390 Dixie Road, Mississauga, Ontario L5T 1P7, Canada

CANON CANADA INC. MONTREAL BRANCH

5990, Côte-de-Liesse, Montréal Québec H4T 1V7, Canada

CANON CANADA INC. CALGARY OFFICE

2828, 16th Street, N.E. Calgary, Alberta T2E 7K7, Canada

For all inquiries concerning this product, call toll free in Canada

1-800-OK-CANON

EUROPE, ————— **CANON EUROPA N.V.**

AFRICA &

MIDDLE EAST

Bovenkerkerweg 59-61, 1185 XB Amstelveen, The Netherlands

CANON FRANCE S.A.S.

17, Quai du Président Paul Doumer, 92414 Courbevoie Cedex, France

CANON UK LTD.

Woodhatch Reigate, Surrey RH2 8BF, United Kingdom

CANON DEUTSCHLAND GmbH

Europark Fichtenhain A10, 47807 Krefeld, Germany

CANON ITALIA S.p.A.

Via Milano 8, 20097 San Donato Milanese, (MI), Italy

CANON Schweiz A.G.

Industriestrasse 12, 8305 Dietlikon, Switzerland

Canon GmbH

Zetschegasse 11, A-1230 Vienna, Austria

CANON España, S.A.

Av. De Europa, 6 Alcobendas 28108 Madrid, Spain

CANON Portugal S.A.

Rua Alfredo da Silva, 14 Alfragide 2610-016 Amadora, Portugal

CENTRAL & ————— **CANON LATIN AMERICA, INC.**

SOUTH AMERICA

703 Waterford Way, Suite 400 Miami, FL 33126, U.S.A.

ASIA ————— **CANON (China) Co., LTD.**

15F Jinbao Building No.89 Jinbao Street, Dongcheng District, Beijing 100005, China

CANON HONGKONG CO., LTD.

19/F., The Metropolis Tower, 10 Metropolis Drive, Hunghom, Kowloon, Hong Kong

CANON SINGAPORE PTE. LTD.

1 HarbourFront Avenue, #04-01 Keppel Bay Tower, Singapore 098632

CANON KOREA CONSUMER IMAGING INC.

Canon BS Tower 5F, #168-12 Samseong-dong, Gangnam-gu, Seoul, Korea

OCEANIA ————— **CANON AUSTRALIA PTY. LTD.**

1 Thomas Holt Drive, North Ryde, Sydney N.S.W. 2113, Australia

CANON NEW ZEALAND LTD.

Akoranga Business Park, Akoranga Drive, Northcote, Auckland, New Zealand

JAPAN ————— **CANON MARKETING JAPAN INC.**

16-6, Kohnan 2-chome, Minato-ku, Tokyo 108-8011, Japan

This Instruction Manual booklet is current as of January 2010. For information on the camera's compatibility with any accessories and lenses introduced after this date, contact any Canon Service Center.