

# SYNTHESIZER **SH-201**

## Owner's Manual

Thank you, and congratulations on your choice of the Roland SH-201.

Before using this unit, carefully read the sections entitled: "USING THE UNIT SAFELY" (p. 8) and "IMPORTANT NOTES" (p. 10). These sections provide important information concerning the proper operation of the unit. Additionally, in order to feel assured that you have gained a good grasp of every feature provided by your new unit, Owner's manual should be read in its entirety. The manual should be saved and kept on hand as a convenient reference.

### To learn about the performance functions...

Playing sounds.....p. 16

### To create your own sounds...

Creating sounds .....p. 27

Parameter list.....p. 60

Block diagram .....p. 75

### To learn how the knobs and buttons work...

Panel descriptions.....p. 2

Panel index .....p. 76

Contents .....p. 4

Index .....p. 78

*\* All product names mentioned in this document are trademarks or registered trademarks of their respective owners.*

Copyright © 2006 ROLAND CORPORATION

All rights reserved. No part of this publication may be reproduced in any form without the written permission of ROLAND CORPORATION.

# Panel descriptions

## Top Panel

### D BEAM (p. 20)

You can move your hand above this sensor to control the pitch or volume.

### MASTER VOL Knob (p. 16)

This sets the volume of the entire SH-201.

### ARPEGGIO (p. 22)

This section lets you produce an arpeggio simply by holding down a chord on the keyboard.

### RECORDER (p. 24)

This section lets you record your performance on the SH-201.

### TEMPO Button/TAP Button

Here you can specify the tempo of the arpeggio and the recorder.

### Pitch Bend/Modulation Lever (p. 18)

While you play, move this lever to the left or right to vary the pitch. Move the lever away from yourself to apply vibrato.

### EXT IN (p. 49)

Here you can play sound from a device connected to the INPUT jacks. You can also cancel a vocal or other sound that is localized at the center of audio you input.

### OSC 1/OSC 2 (p. 28)

This is the creative core, where the process of sound production on the synthesizer begins. It generates the waveform that determines the character of the sound, and determines the pitch.

### PITCH ENV (p. 31)

This creates time-varying changes in pitch, such as the subtle pitch deviation that occurs when you begin blowing a note on a brass instrument, or the dramatic pitch swoop of an electronic drum.

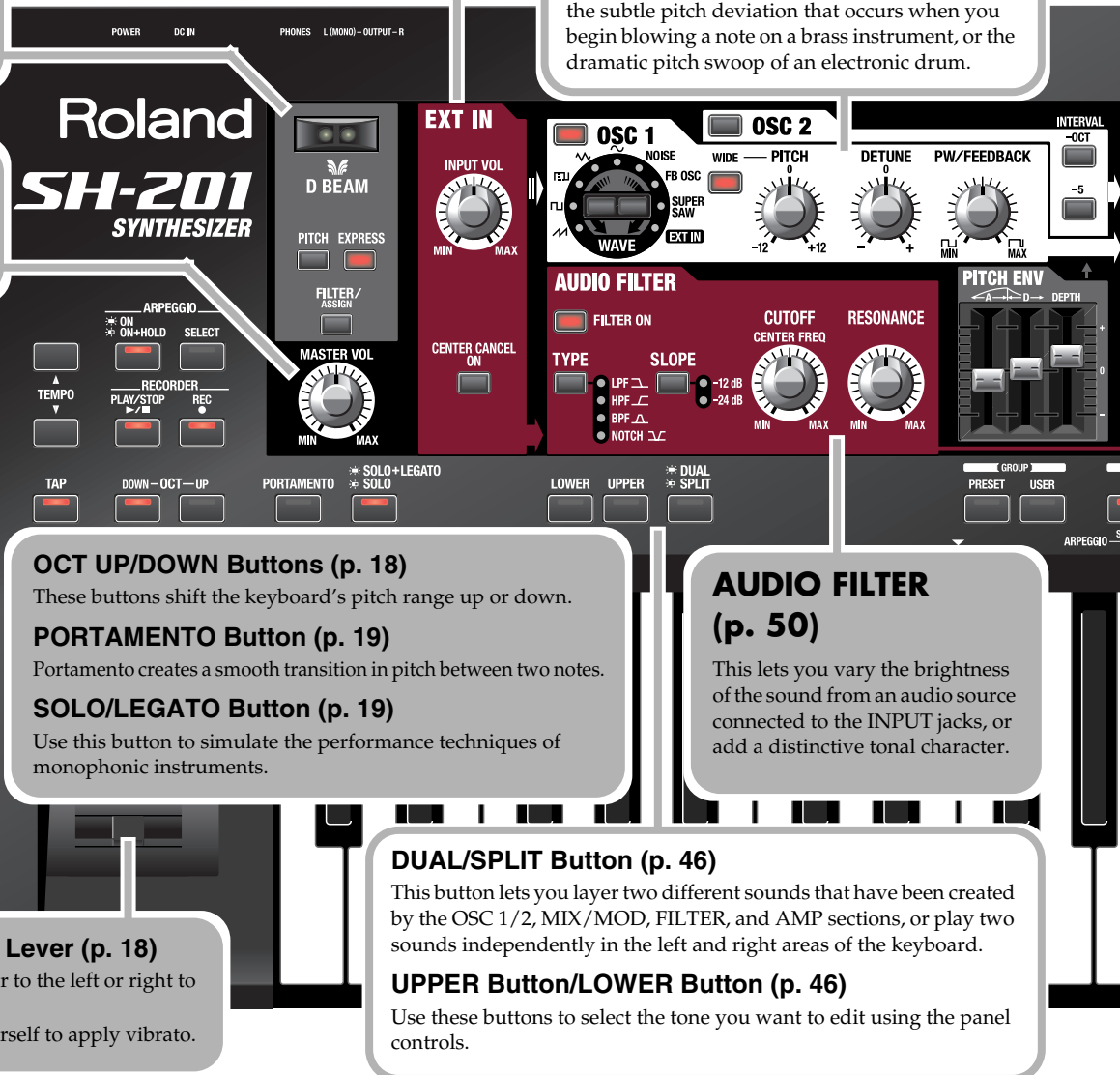

### OCT UP/DOWN Buttons (p. 18)

These buttons shift the keyboard's pitch range up or down.

### PORTAMENTO Button (p. 19)

Portamento creates a smooth transition in pitch between two notes.

### SOLO/LEGATO Button (p. 19)

Use this button to simulate the performance techniques of monophonic instruments.

### AUDIO FILTER (p. 50)

This lets you vary the brightness of the sound from an audio source connected to the INPUT jacks, or add a distinctive tonal character.

### DUAL/SPLIT Button (p. 46)

This button lets you layer two different sounds that have been created by the OSC 1/2, MIX/MOD, FILTER, and AMP sections, or play two sounds independently in the left and right areas of the keyboard.

### UPPER Button/LOWER Button (p. 46)

Use these buttons to select the tone you want to edit using the panel controls.

## Rear Panel

N225  
 FC CE  
 MODEL SH-201  
 3025, 1992

THIS CLASS B DIGITAL APPARATUS MEETS ALL REQUIREMENTS OF THE CANADIAN INTERFERENCE-CANUSING EQUIPMENT REGULATIONS.  
 CET APPAREIL NUMÉRIQUE DE LA CLASSE B RESPECTE TOUTES LES EXIGENCES DU RÈGLEMENT SUR LE MATÉRIEL BRUYANT/LEUR DU CANADA.

THE D BEAM HAS BEEN LICENSED FROM INTERMUSIC LIGHT INC.  
 Roland Corporation  
 MADE IN CHINA

# Roland SH-

**MIX/MOD (p. 32)**

This mixes the waveforms generated by OSC 1 and OSC 2 to create a richer sound. Here you can also boost or cut the low-frequency range.

**FILTER (p. 34)**

This adjusts the brightness or thickness of the sound produced in the MIX/MOD section. Here you can also add a distinctive tonal character that is typical of synthesizer sounds.

**FILTER ENV (p. 37)**

Here you can create time-varying changes in tone, such as the way in which a note played on a piano begins with a bright tone and gradually becomes more mellow.

**AMP (p. 38)**

This determines the loudness of the sound that has passed through the FILTER section. Here you can also distort the sound to make it more powerful.

**AMP ENV (p. 38)**

Here you can create time-varying changes in volume, such as the way in which a note played on a piano gradually diminishes, or the way in which notes on a bowed-string instrument begin gradually.

**EFFECTS (p. 44)**

Here you can add depth and spaciousness to the sound by applying effects such as echo or reverberation to simulate the acoustic character of a room or hall.

**LFO 1/LFO 2 (p. 40)**

Here you can apply cyclic change to the sound, such as modulating the pitch to create vibrato, or modulating the volume to create tremolo.

**GROUP/BANK/NUMBER Buttons (p. 16)**

Use these buttons to select the patch you want to play. If the ARPEGGIO SELECT button's indicator is lit, these buttons will select an arpeggio template (p. 23).

**WRITE Button/CANCEL Button (p. 48)**

Use these buttons to save a sound you've created.

**PEDAL Jack (p. 21)**

Connect a pedal switch (DP series; sold separately) or expression pedal (EV-5; sold separately) to this jack.

**INPUT Jacks (p. 49)**

Connect your digital audio player, CD player, or sampler to these jacks.

**OUTPUT Jacks (p. 13)**

Connect your monitor speakers or stereo set to these jacks.

**POWER Switch (p. 14)**

This switch turns the power on/off.

**USB Connector (p. 54)**

Connect this to your computer.

**MIDI Connectors (p. 58)**

Connect other MIDI devices to these connectors.

**PHONES Jack (p. 13)**

Connect headphones (sold separately) to this jack.

**DC IN Jack (p. 12)**

Connect the included AC adaptor to this jack.

201

# Contents

<b>Panel descriptions .....</b>	<b>2</b>
<b>Main features .....</b>	<b>7</b>
<b>USING THE UNIT SAFELY .....</b>	<b>8</b>
<b>IMPORTANT NOTES .....</b>	<b>10</b>
<b>Before you begin.....</b>	<b>12</b>
Making the connections.....	12
Connecting the power adaptor .....	12
Connecting headphones or speakers.....	13
Turning the power on/off.....	14
Turning the power off .....	14
<b>Basic structure of the SH-201 .....</b>	<b>15</b>
How sound is produced .....	15
<b>Playing sounds .....</b>	<b>16</b>
Adjusting the volume (MASTER VOL).....	16
Selecting a sound to play (GROUP/BANK/NUMBER) .....	16
About Patches .....	17
Restoring the original settings (Factory Reset) .....	17
Adding expression to your playing (Velocity).....	18
Varying the pitch of the notes you play/ Adding vibrato (Pitch Bend/Modulation lever) .....	18
Shifting the pitch range of the keyboard (OCT UP/DOWN) .....	18
Smoothly connecting the pitch of two notes (PORTAMENTO).....	19
Playing monophonically (SOLO/LEGATO).....	19
Moving your hand to vary the pitch or volume (D BEAM).....	20
Changing the pitch (PITCH).....	20
Changing the volume to add expression to your performance (EXPRESS).....	20
Changing the brightness or other aspects of the sound (FILTER/ ASSIGN).....	21
Sustaining the notes (Hold pedal).....	21
Adding dynamics to your performance (Expression pedal).....	21
Automatically playing arpeggios (ARPEGGIO) .....	22
Playing arpeggios (ON/HOLD) .....	22
Selecting how the arpeggio is to sound (SELECT) .....	23
Recording your performance (RECORDER) .....	24
Recording .....	24
Saving a recorded phrase .....	25
Playback.....	26
<b>Creating sounds.....</b>	<b>27</b>
How sounds are created .....	27
Specifying the waveform and pitch (OSC) .....	28
OSC 1 (oscillator 1) button/OSC 2 (oscillator 2) button.....	28
WAVE buttons.....	28
PITCH knob .....	29
DETUNE knob .....	29
PW/FEEDBACK (Pulse Width/Feedback) knob.....	30
INTERVAL buttons .....	30
PITCH ENV (pitch envelope) sliders .....	31
Combining waveforms to create rich or metallic sounds (MIX/MOD).....	32
TYPE button.....	32
BALANCE knob .....	33
LOW FREQ (low frequency) button.....	33

Specifying the brightness and thickness of the sound (FILTER).....	34
TYPE button.....	34
SLOPE button .....	35
CUTOFF knob.....	35
RESONANCE knob .....	36
KEY FOLLOW knob .....	36
FILTER ENV (filter envelope) sliders.....	37
Specifying how the sound begins and ends (AMP) .....	38
LEVEL knob .....	38
AMP ENV (amp envelope) sliders .....	38
Creating a powerful, distorted sound (OVERDRIVE) .....	39
OVERDRIVE button .....	39
Modulating the sound (LFO).....	40
LFO 1 button/LFO 2 button .....	40
SHAPE buttons.....	40
RATE knob .....	41
DESTINATION 1 .....	42
DESTINATION 2 .....	43
Adding depth and spaciousness to the sound (EFFECTS).....	44
EDIT button.....	44
FX ON (effect on) button.....	44
TIME knob.....	45
DEPTH knob .....	45
Combining two sounds (DUAL/SPLIT).....	46
Layering two sounds to play them simultaneously (DUAL) .....	46
Playing different sounds in the right and left hands (SPLIT).....	47
Saving a sound you create (WRITE).....	48

## Performing with sound from your digital audio player, etc.

<b>(EXT IN) .....</b>	<b>49</b>
Connecting your digital audio player, etc. ....	49
Adjusting the volume from the external source (INPUT VOL knob) .....	49
Canceling the center sound (CENTER CANCEL ON button) .....	49
Modifying the sound from the external source (AUDIO FILTER) .....	50
FILTER ON button.....	50
TYPE button.....	50
SLOPE button .....	51
CUTOFF knob.....	51
RESONANCE knob .....	51
Using the keyboard to play sound from an external source (WAVE - EXT IN) .....	52
Producing sound from the external device only when you play the keyboard .....	53

## Using the SH-201 together with your computer or another sound module .....

<b>54</b>	<b>54</b>
Using your computer to record sound or performance data from the SH-201 (USB).....	54
USB audio signal flow .....	55
Creating sounds in greater detail (Editor)/	
Using your computer to manage patches (Librarian).....	56
Using SH-201 Editor to create sounds and arpeggios .....	56
Using SH-201 Librarian to manage patches .....	56
SH-201 Editor System requirements .....	57
Using the SH-201 as a controller or a sound module (MIDI).....	58
About MIDI connectors.....	58
MIDI channels.....	58
Using an external sequencer to play the SH-201's internal sound generator (MIDI IN)....	59
Using the SH-201's keyboard and knobs to play an external sound module (MIDI OUT).....	59

**Parameter list .....60**

- OSC MIX/MOD parameters..... 60
- FILTER & AMP parameters ..... 61
- LFO parameters ..... 62
- EFFECTS parameters ..... 63
- PATCH COMMON parameters..... 64
- ARPEGGIO parameters..... 66
  - About arpeggio styles..... 67
- SYSTEM COMMON parameters ..... 68
- Other parameters..... 70
- Setting the SPLIT POINT..... 71
- Setting the PITCH BEND RANGE..... 71

**Control change message list .....72**

**MIDI implementation chart .....73**

**Specifications.....74**

**Block diagram .....75**

**Panel index .....76**

**Index.....78**

**Patch list .....84**

# Main features

---

## **Operating layout that's faithful to synthesizer basics**

The operating panel is laid out in a way that helps you intuitively understand how a synthesizer produces sound. If you're using a synthesizer for the first time to create sound you'll find the SH-201 easy to learn, and if you're familiar with the basics of analog synthesizers you'll be able to start using it immediately even without the owner's manual.

## **High-quality and practical analog modeling sounds**

The SH-201 contains an analog modeling sound generator that distills the essence of Roland's sound-generating technology. From familiar synth leads and basses to motion pads and synth sounds for contemporary dance music, the SH-201 gives you a broad variety of top-notch sounds.

## **Audio input jack that's great for DJ performance**

The SH-201 is equipped with audio input jacks for connecting your digital audio player or an external sampler. You can modify these sounds in real time by turning the knobs to control the dedicated filter that's built-in. You can also use an external audio source as the oscillator for the sound generation section, and use the keyboard or the arpeggiator to apply rhythm variation to the sound (p. 49).

## **Enhanced linkage with your computer**

The USB connector supports both USB-MIDI connection and USB audio input/output. The SH-201 comes with dedicated editor software that provides full editing capability for creating more complex sounds or for programming the internal arpeggiator, as well as librarian software for saving and managing your own sounds (p. 56). The dedicated editor is also provided as a plug-in version that you can run from within your VSTi-compatible DAW.

## **Use the D Beam controller for more visual performances**

The SH-201's D Beam controller lets you produce dramatic changes in the sound simply by moving your hand above the sensor. You can use this to control a wide range of the settings that are assigned to the panel knobs. The D Beam can add a more intensely visual element to your stage performance (p. 20).

## **Two-tone structure for creating diverse and expressive sounds**

While the SH-201 is a mere 5.2 kg in weight, it packs the sound-generating power of two analog synthesizers, letting you play upper and lower tones simultaneously. You can split the two tones to different areas of the keyboard, or layer them to create rich and complex sounds (p. 46).

**IMPORTANT:** THE WIRES IN THIS MAINS LEAD ARE COLOURED IN ACCORDANCE WITH THE FOLLOWING CODE.

BLUE: NEUTRAL  
BROWN: LIVE

As the colours of the wires in the mains lead of this apparatus may not correspond with the coloured markings identifying the terminals in your plug, proceed as follows:  
The wire which is coloured BLUE must be connected to the terminal which is marked with the letter N or coloured BLACK.  
The wire which is coloured BROWN must be connected to the terminal which is marked with the letter L or coloured RED.  
Under no circumstances must either of the above wires be connected to the earth terminal of a three pin plug.

## USING THE UNIT SAFELY

### INSTRUCTIONS FOR THE PREVENTION OF FIRE, ELECTRIC SHOCK, OR INJURY TO PERSONS

#### About ⚠ WARNING and ⚠ CAUTION Notices

<b>⚠ WARNING</b>	Used for instructions intended to alert the user to the risk of death or severe injury should the unit be used improperly.
<b>⚠ CAUTION</b>	Used for instructions intended to alert the user to the risk of injury or material damage should the unit be used improperly. * Material damage refers to damage or other adverse effects caused with respect to the home and all its furnishings, as well to domestic animals or pets.

#### About the Symbols

	The ⚠ symbol alerts the user to important instructions or warnings. The specific meaning of the symbol is determined by the design contained within the triangle. In the case of the symbol at left, it is used for general cautions, warnings, or alerts to danger.
	The ⓧ symbol alerts the user to items that must never be carried out (are forbidden). The specific thing that must not be done is indicated by the design contained within the circle. In the case of the symbol at left, it means that the unit must never be disassembled.
	The ● symbol alerts the user to things that must be carried out. The specific thing that must be done is indicated by the design contained within the circle. In the case of the symbol at left, it means that the power-cord plug must be unplugged from the outlet.

### ALWAYS OBSERVE THE FOLLOWING

#### ⚠ WARNING

- Before using this unit, make sure to read the instructions below, and the Owner's Manual.

---

- Do not open (or modify in any way) the unit or its AC adaptor.

---

- Do not attempt to repair the unit, or replace parts within it (except when this manual provides specific instructions directing you to do so). Refer all servicing to your retailer, the nearest Roland Service Center, or an authorized Roland distributor, as listed on the "Information" page.

---

- Never use or store the unit in places that are:
  - Subject to temperature extremes (e.g., direct sunlight in an enclosed vehicle, near a heating duct, on top of heat-generating equipment); or are
  - Damp (e.g., baths, washrooms, on wet floors); or are
  - Humid; or are
  - Exposed to rain; or are
  - Dusty; or are
  - Subject to high levels of vibration.

#### ⚠ WARNING

- This unit should be used only with a stand that is recommended by Roland.

---

- When using the unit with a stand recommended by Roland, the rack or stand must be carefully placed so it is level and sure to remain stable. If not using a stand, you still need to make sure that any location you choose for placing the unit provides a level surface that will properly support the unit, and keep it from wobbling.

---

- Be sure to use only the AC adaptor supplied with the unit. Also, make sure the line voltage at the installation matches the input voltage specified on the AC adaptor's body. Other AC adaptors may use a different polarity, or be designed for a different voltage, so their use could result in damage, malfunction, or electric shock.

---









- Use only the attached power-supply cord. Also, the supplied power cord must not be used with any other device.

---











- Do not excessively twist or bend the power cord, nor place heavy objects on it. Doing so can damage the cord, producing severed elements and short circuits. Damaged cords are fire and shock hazards!



## ⚠ WARNING

- This unit, either alone or in combination with an amplifier and headphones or speakers, may be capable of producing sound levels that could cause permanent hearing loss. Do not operate for a long period of time at a high volume level, or at a level that is uncomfortable. If you experience any hearing loss or ringing in the ears, you should immediately stop using the unit, and consult an audiologist. 
- Do not allow any objects (e.g., flammable material, coins, pins); or liquids of any kind (water, soft drinks, etc.) to penetrate the unit.   

- Immediately turn the power off, remove the AC adaptor from the outlet, and request servicing by your retailer, the nearest Roland Service Center, or an authorized Roland distributor, as listed on the "Information" page when:  
  - The AC adaptor, the power-supply cord, or the plug has been damaged; or
  - If smoke or unusual odor occurs
  - Objects have fallen into, or liquid has been spilled onto the unit; or
  - The unit has been exposed to rain (or otherwise has become wet); or
  - The unit does not appear to operate normally or exhibits a marked change in performance.
- In households with small children, an adult should provide supervision until the child is capable of following all the rules essential for the safe operation of the unit. 
- Protect the unit from strong impact. (Do not drop it!) 
- Do not force the unit's power-supply cord to share an outlet with an unreasonable number of other devices. Be especially careful when using extension cords—the total power used by all devices you have connected to the extension cord's outlet must never exceed the power rating (watts/amperes) for the extension cord. Excessive loads can cause the insulation on the cord to heat up and eventually melt through. 
- Before using the unit in a foreign country, consult with your retailer, the nearest Roland Service Center, or an authorized Roland distributor, as listed on the "Information" page. 
- DO NOT play a CD-ROM disc on a conventional audio CD player. The resulting sound may be of a level that could cause permanent hearing loss. Damage to speakers or other system components may result. 

## ⚠ CAUTION

- The unit and the AC adaptor should be located so their location or position does not interfere with their proper ventilation. 
- This SH-201 for use only with Roland stand KS-12. Use with other stands is capable of resulting in instability causing possible injury. 
- Always grasp only the plug on the AC adaptor cord when plugging into, or unplugging from, an outlet or this unit. 
- At regular intervals, you should unplug the AC adaptor and clean it by using a dry cloth to wipe all dust and other accumulations away from its prongs. Also, disconnect the power plug from the power outlet whenever the unit is to remain unused for an extended period of time. Any accumulation of dust between the power plug and the power outlet can result in poor insulation and lead to fire. 
- Try to prevent cords and cables from becoming entangled. Also, all cords and cables should be placed so they are out of the reach of children. 
- Never climb on top of, nor place heavy objects on the unit. 
- Never handle the AC adaptor or its plugs with wet hands when plugging into, or unplugging from, an outlet or this unit. 
- Before moving the unit, disconnect the AC adaptor and all cords coming from external devices. 
- Before cleaning the unit, turn off the power and unplug the AC adaptor from the outlet. 
- Whenever you suspect the possibility of lightning in your area, disconnect the AC adaptor from the outlet. 

# IMPORTANT NOTES

In addition to the items listed under “USING THE UNIT SAFELY” on pages 8–9, please read and observe the following:

## Power Supply

- Do not connect this unit to same electrical outlet that is being used by an electrical appliance that is controlled by an inverter (such as a refrigerator, washing machine, microwave oven, or air conditioner), or that contains a motor. Depending on the way in which the electrical appliance is used, power supply noise may cause this unit to malfunction or may produce audible noise. If it is not practical to use a separate electrical outlet, connect a power supply noise filter between this unit and the electrical outlet.
- The AC adaptor will begin to generate heat after long hours of consecutive use. This is normal, and is not a cause for concern.
- Before connecting this unit to other devices, turn off the power to all units. This will help prevent malfunctions and/or damage to speakers or other devices.

## Placement

- Using the unit near power amplifiers (or other equipment containing large power transformers) may induce hum. To alleviate the problem, change the orientation of this unit; or move it farther away from the source of interference.
- This device may interfere with radio and television reception. Do not use this device in the vicinity of such receivers.
- Noise may be produced if wireless communications devices, such as cell phones, are operated in the vicinity of this unit. Such noise could occur when receiving or initiating a call, or while conversing. Should you experience such problems, you should relocate such wireless devices so they are at a greater distance from this unit, or switch them off.
- Do not expose the unit to direct sunlight, place it near devices that radiate heat, leave it inside an enclosed vehicle, or otherwise subject it to temperature extremes. Excessive heat can deform or discolor the unit.
- When moved from one location to another where the temperature and/or humidity is very different, water droplets (condensation) may form inside the unit. Damage or malfunction may result if you attempt to use the unit in this condition. Therefore, before using the unit, you must allow it to stand for several hours, until the condensation has completely evaporated.
- Do not allow objects to remain on top of the keyboard. This can be the cause of malfunction, such as keys ceasing to produce sound.

- Depending on the material and temperature of the surface on which you place the unit, its rubber feet may discolor or mar the surface.  
You can place a piece of felt or cloth under the rubber feet to prevent this from happening. If you do so, please make sure that the unit will not slip or move accidentally.

## Maintenance

- For everyday cleaning wipe the unit with a soft, dry cloth or one that has been slightly dampened with water. To remove stubborn dirt, use a cloth impregnated with a mild, non-abrasive detergent. Afterwards, be sure to wipe the unit thoroughly with a soft, dry cloth.
- Never use benzine, thinners, alcohol or solvents of any kind, to avoid the possibility of discoloration and/or deformation.

## Repairs and Data

- Please be aware that all data contained in the unit's memory may be lost when the unit is sent for repairs. Important data should always be backed up in a computer, or written down on paper (when possible). During repairs, due care is taken to avoid the loss of data. However, in certain cases (such as when circuitry related to memory itself is out of order), we regret that it may not be possible to restore the data, and Roland assumes no liability concerning such loss of data.

## Additional Precautions

- Please be aware that the contents of memory can be irretrievably lost as a result of a malfunction, or the improper operation of the unit. To protect yourself against the risk of losing important data, we recommend that you periodically save a backup copy of important data you have stored in the unit's memory in a computer.
- Unfortunately, it may be impossible to restore the contents of data that was stored in the unit's memory or a computer once it has been lost. Roland Corporation assumes no liability concerning such loss of data.
- Use a reasonable amount of care when using the unit's buttons, sliders, or other controls; and when using its jacks and connectors. Rough handling can lead to malfunctions.
- When connecting / disconnecting all cables, grasp the connector itself—never pull on the cable. This way you will avoid causing shorts, or damage to the cable's internal elements.
- To avoid disturbing your neighbors, try to keep the unit's volume at reasonable levels. You may prefer to use headphones, so you do not need to be concerned about those around you (especially when it is late at night).
- When you need to transport the unit, package it in the box (including padding) that it came in, if possible. Otherwise, you will need to use equivalent packaging materials.
- Use only the specified expression pedal (EV-5; sold separately). By connecting any other expression pedals, you risk causing malfunction and/or damage to the unit.
- Some connection cables contain resistors. Do not use cables that incorporate resistors for connecting to this unit. The use of such cables can cause the sound level to be extremely low, or impossible to hear. For information on cable specifications, contact the manufacturer of the cable.
- The sensitivity of the D Beam controller will change depending on the amount of light in the vicinity of the unit. If it does not function as you expect, adjust the sensitivity as appropriate for the brightness of your location.

## Handling CD-ROMs

- Avoid touching or scratching the shiny underside (encoded surface) of the disc. Damaged or dirty CD-ROM discs may not be read properly. Keep your discs clean using a commercially available CD cleaner.

# Before you begin

## Making the connections

\* To prevent malfunction and/or damage to speakers or other devices, always turn down the volume, and turn off the power on all devices before making any connections.

### Connecting the power adaptor

Connect the included AC adaptor (PSB-1U) to the DC IN jack located on the SH-201's rear panel.

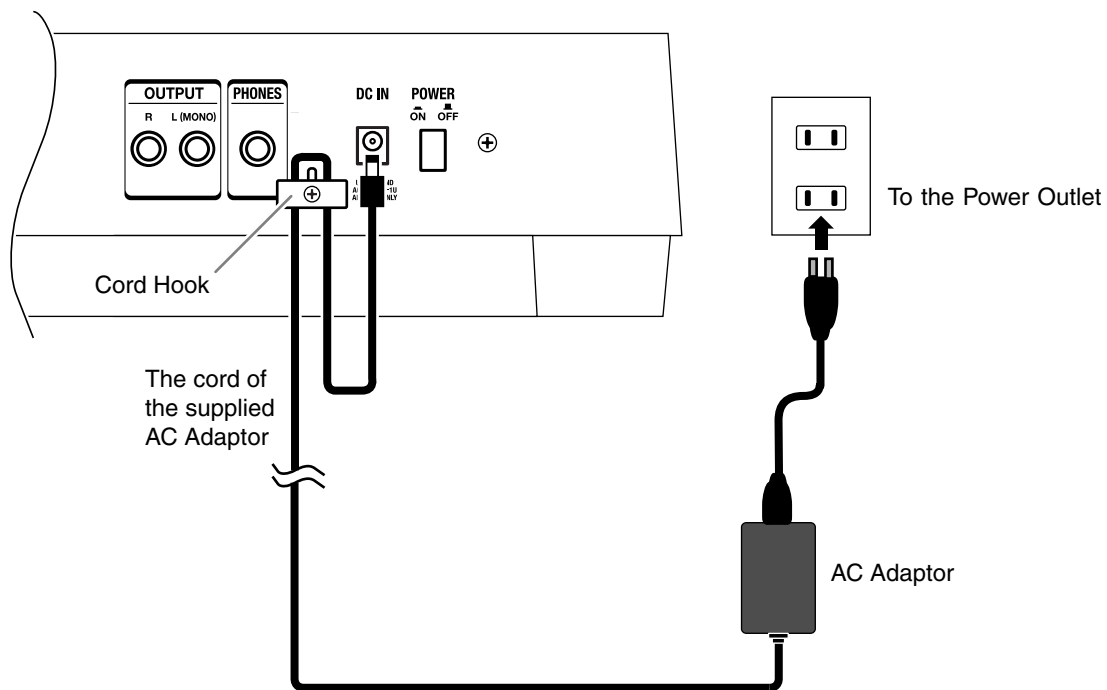

\* To prevent the inadvertent disruption of power to your unit (should the plug be pulled out accidentally), and to avoid applying undue stress to the AC adaptor jack, anchor the power cord using the cord hook, as shown in the illustration.

## Connecting headphones or speakers

Since the SH-201 does not contain speakers, it cannot produce sound by itself. In order to produce sound, you must connect monitor speakers, a stereo set or other audio system, or headphones.

### Connecting monitor speakers or a stereo set

Use the appropriate cables to connect the OUTPUT jacks on the SH-201's rear panel to your monitor speakers or stereo set.

\* In order to take full advantage of the SH-201's capabilities, we recommend that you make connections in stereo. If you're making connections in monaural, connect to the OUTPUT L (MONO) jack.

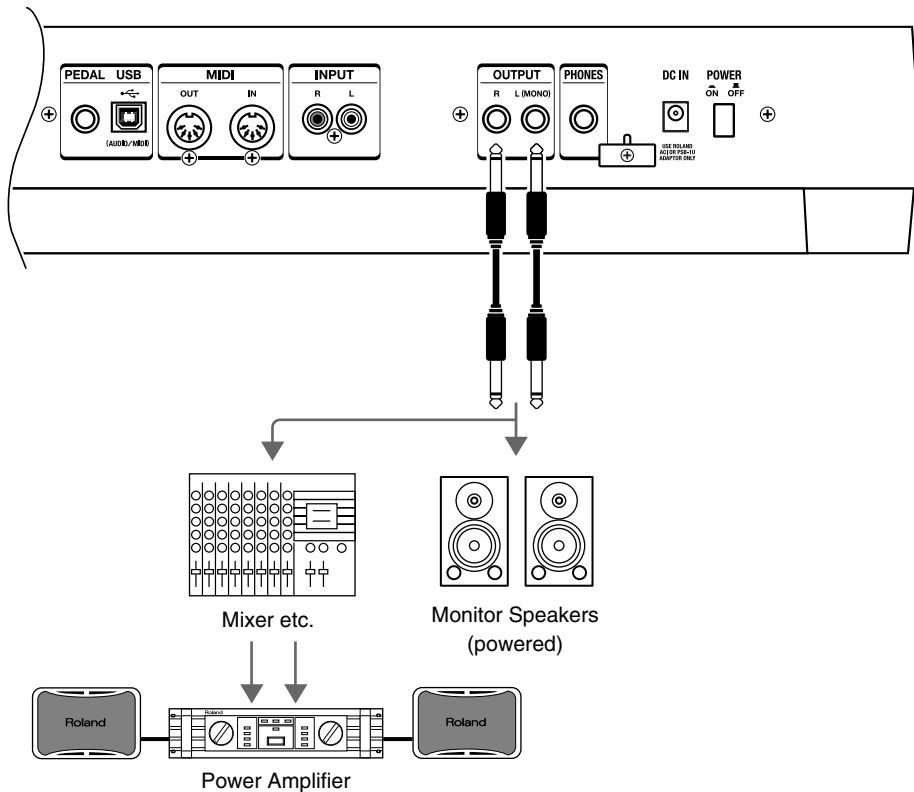

### Connecting headphones

Connect your stereo headphones to the PHONES jack on the rear panel of the SH-201.

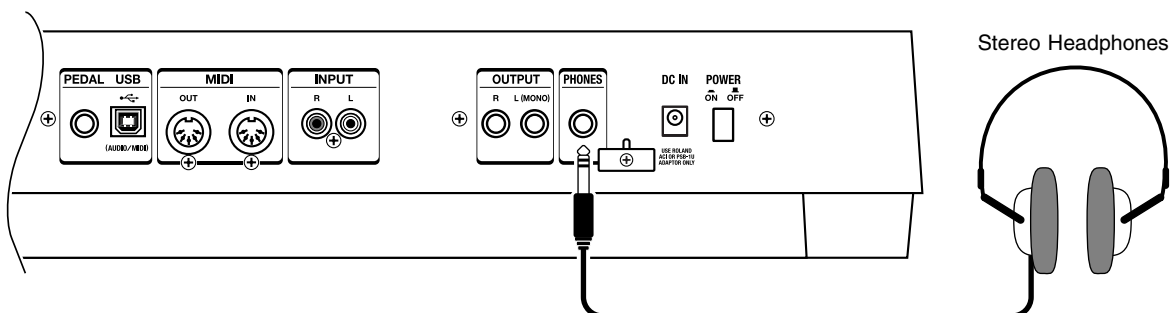

\* Sound will be sent out from the OUTPUT jacks even if headphones are connected.

## Turning the power on/off

\* Once the connections have been completed (p. 12, p. 13), turn on power to your various devices in the order specified. By turning on devices in the wrong order, you risk causing malfunction and/or damage to speakers and other devices.

**1** Check the following points before you turn on the power.

- Are the connections made correctly?
- Is the power on all connected equipment turned off?

**2** On the SH-201's top panel, turn the MASTER VOL knob all the way to the left.

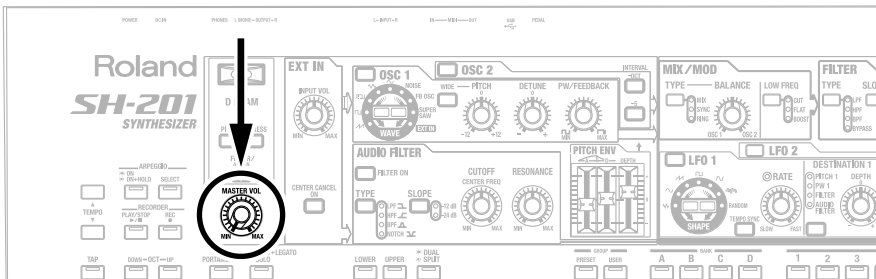

**3** On the SH-201's rear panel, press the POWER switch to select the "ON" position.

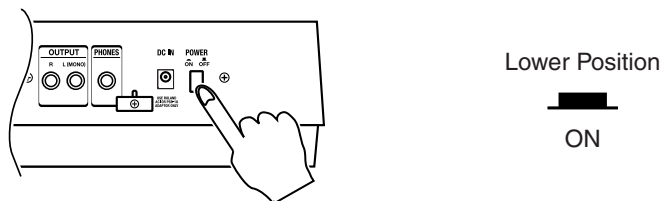

\* This unit is equipped with a protection circuit. A brief interval (a few seconds) after power up is required before the unit will operate normally.

\* Don't touch the pitch bend lever located at the left of the keyboard while you're turning on the power. If you turn on the power while touching the pitch bend lever, the lever may fail to operate correctly.



Do not touch!

**4** Switch on the power to the connected equipment and raise the volume to an appropriate level.

**5** While playing the SH-201's keyboard, slowly turn the MASTER VOL knob toward the right to an appropriate volume.

## Turning the power off

**1** Check the following points before you turn off the power.

- Is the volume of the connected equipment turned to the minimum setting?
- Have you saved the sounds you created? (p. 48)

**2** Switch off the power on the connected equipment.

**3** Press the SH-201's POWER switch to select the "OFF" position.



# Basic structure of the SH-201

Broadly speaking, the SH-201 consists of a **controller section** and a **sound generator section**.

## Controller section

The controller section is what you play.

This section conveys the performer's actions (for example, "playing a note") to the sound generator section, causing it to produce sound.

The SH-201's controller section consists of a keyboard, a pitch bend/modulation lever, the D Beam, the knobs and buttons of the panel, and a pedal (sold separately) connected to the rear panel.

## Sound generator section

The sound generator section is what actually produces the sound.

According to the performance data it receives from the controller section, the sound generator section electronically creates the basic waveform of the sound, and specifies the tone and volume to create a wide range of sounds.

The SH-201's sound generator section provides numerous knobs and buttons on the panel to make it easy for you to quickly adjust the various aspects that determine the sound (waveform, pitch, tone, volume, etc.).

## How sound is produced

Suppose that you play the "C" note on the keyboard. The keyboard sends a message of "the C note (key) was played" to the sound generator. The sound generator receives this message and produces the sound of that note.

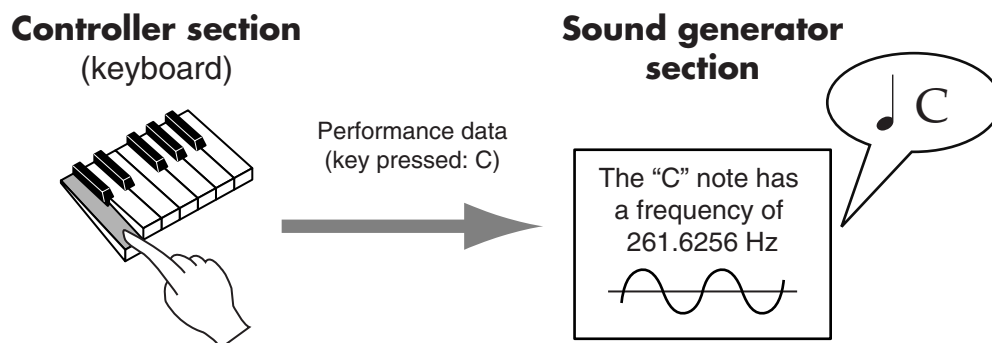

Next, suppose that you release that "C" note. The keyboard sends a message of "the C note (key) was released" to the sound generator. The sound generator receives this message, and stops producing the sound of that note.

In reality, the controller section is sending more information than this to the controller section (such as the strength with which you played that note). Based on the various types of information it receives, the sound generator section can produce a wide range of sounds.

- **More about the controller section**

For more about the controller section, refer to "Playing sounds" starting on p. 16.

- **More about the sound generator section**

Details on the sound generator section are given in "Creating sounds" starting on p. 27.

# Playing sounds

## Adjusting the volume (MASTER VOL)

This knob adjusts the overall volume of the SH-201, and affects the output from the rear panel OUTPUT jacks and the PHONES jack.

Turning the knob toward the right increases the volume, and turning it toward the left decreases the volume.

If you turn the knob all the way to the left, there will be no sound.

\* Turning this knob will not change the output volume of the USB audio (p. 55). You'll have to adjust the volume on the USB-connected device (e.g., your computer).

Roland  
**SH-201**  
SYNTHESIZER

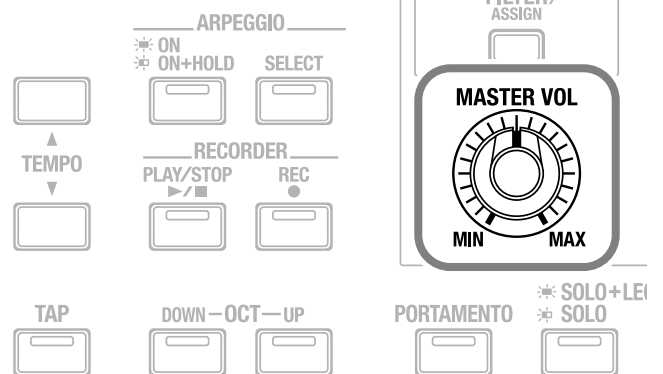

## Selecting a sound to play (GROUP/BANK/NUMBER)

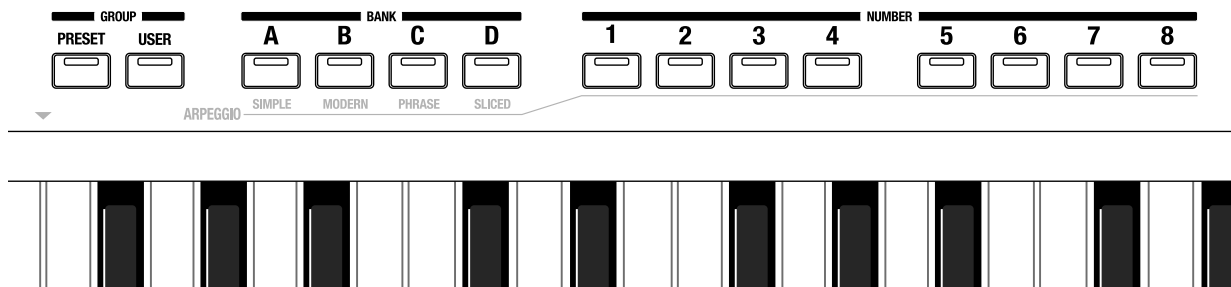

GROUP buttons (PRESET and USER), BANK buttons (A–D), and NUMBER buttons (1–8) for selecting patches are located immediately above the keyboard.

Press the GROUP button, BANK button, and NUMBER button for the patch you want to play.

The patch will change immediately when you press a button.

### Examples:

- If the USER A-1 patch is selected, pressing the NUMBER 6 button switches you to the USER A-6 patch.
- If the PRESET A-3 patch is selected, pressing the BANK C button switches you to the PRESET C-3 patch.
- If the PRESET B-5 patch is selected, pressing the USER button switches you to the USER B-5 patch.



## About Patches

The SH-201 lets you save the sounds you create.

Sounds you create are called “patches.” You can use the panel buttons to select the patch you want to play.

Patches are organized into two groups; the **preset group** and the **user group**.

Each of these is further organized into four **banks**, each containing eight **numbers**, for a total of 32 patches.

		Preset Group							
		Number							
		1	2	3	4	5	6	7	8
Bank	A	A-1	A-2	A-3	A-4	A-5	A-6	A-7	A-8
	B	B-1	B-2	B-3	B-4	B-5	B-6	B-7	B-8
	C	C-1	C-2	C-3	C-4	C-5	C-6	C-7	C-8
	D	D-1	D-2	D-3	D-4	D-5	D-6	D-7	D-8

32 read-only patches

		User Group							
		Number							
		1	2	3	4	5	6	7	8
Bank	A	A-1	A-2	A-3	A-4	A-5	A-6	A-7	A-8
	B	B-1	B-2	B-3	B-4	B-5	B-6	B-7	B-8
	C	C-1	C-2	C-3	C-4	C-5	C-6	C-7	C-8
	D	D-1	D-2	D-3	D-4	D-5	D-6	D-7	D-8

32 rewritable patches

### Preset group (PRESET)

These are 32 patches that are built into the SH-201.

You can't rewrite the contents of these patches, but you can use them as a starting point when creating your own new patches.

### User group (USER)

These are 32 patches that you create and save.

For details on how to save your patches, refer to **Saving a sound you create (WRITE)** (p. 48).

### Banks

The banks provide a convenient way to organize the 32 patches.

For example you might use bank A to hold the patches you use in the first song of your performance, and bank B to hold the patches for the second song. Alternatively, you could put your synth bass patches in bank A and your lead patches in bank B.

For details on how to select patches, refer to **Selecting a sound to play (GROUP/BANK/NUMBER)** (p. 16).

## Restoring the original settings (Factory Reset)

You can restore the user patches and phrases (p. 24) and arpeggio settings (p. 66) to the factory-set condition.

### NOTE

When you carry out a Factory Reset, the user patches, phrases, and arpeggio settings you've created will disappear.

#### 1. While together holding down both the PRESET and USER buttons, switch on the SH-201.

The WRITE button and CANCEL button will blink.

#### 2. Press the WRITE button.

If you decide to cancel, press the CANCEL button.

# Adding expression to your playing (Velocity)

The SH-201's keyboard produces volume (or brightness) changes in response to your playing dynamics.

The strength with which you play the keyboard is called the "key velocity."

\* If you want to change the way in which the sound responds to your keyboard playing velocity, adjust the **FILTER & AMP parameters** (p. 61) **LEVEL VELOCITY SENS** (volume) and **CUTOFF VELOCITY SENS** (brightness).

# Varying the pitch of the notes you play/ Adding vibrato (Pitch Bend/Modulation lever)

- Moving the lever toward the left lowers the pitch of the notes you're playing ("Pitch Bend"); moving the lever toward the right raises the pitch.
- Pushing the lever away from yourself adds vibrato ("Modulation") to the notes you're playing.
- Moving the lever to left or right while pushing it away from yourself applies pitch bend and modulation at the same time.

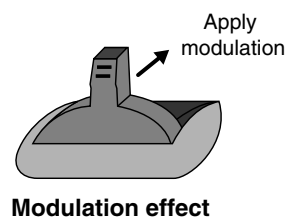
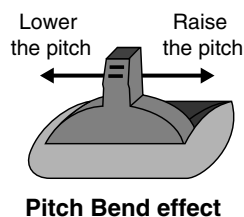

## Pitch bend range

Moving the lever all the way to the left (or right) lowers (or raises) the pitch by a whole step (two semitones).

\* If you want to increase or decrease the range of change, refer to **Setting the PITCH BEND RANGE** (p. 71).

## Modulation speed and shape

You can use the LFO 2 parameters SHAPE (p. 40) and RATE (p. 41) to vary the speed and shape of the vibrato that is applied when you move the lever away from yourself.

# Shifting the pitch range of the keyboard (OCT UP/DOWN)

You can shift the range of the keyboard in one-octave steps, over a maximum of three octaves upward or downward.

For example, if you're using your right hand to play a synth bass sound, shifting the keyboard pitch down by one octave will make it more convenient to play the keyboard.

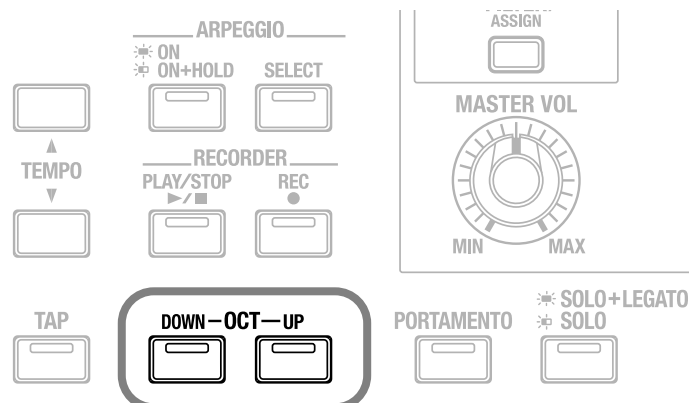

- Press the OCT UP button to shift the pitch upward. Each press shifts the keyboard one octave upward.
  - Press the OCT DOWN button to shift the pitch downward. Each press shifts the keyboard one octave downward. The OCT UP button's indicator will light if the keyboard pitch range has been raised above the normal range. The OCT DOWN button's indicator will light if the range has been lowered.
- You can return to the normal range by simultaneously pressing the OCT UP and OCT DOWN buttons. (The indicators for both buttons go out.)

## Smoothly connecting the pitch of two notes (PORTAMENTO)

You can make a smooth transition in pitch between one note and the next. This effect is called “portamento.”

To apply portamento, press the PORTAMENTO button so its indicator is lit.

### Changing the speed of the pitch change

To change the speed at which the pitch change occurs (i.e., the “portamento time”), hold down the PORTAMENTO button and press one of the NUMBER buttons (1–8) located immediately above the keyboard.

Pressing a higher-numbered NUMBER button selects a correspondingly longer portamento time, producing a slower change in pitch.

You can also adjust the portamento time by holding down the PORTAMENTO button and turning the EFFECTS TIME knob (p. 45).



## Playing monophonically (SOLO/LEGATO)

When playing sounds of instruments that are naturally monophonic, such as sax or flute, this function will help your performance be more realistic.

- When you press the SOLO button so its indicator is lit, Solo and Legato are both turned on.
- When you press the SOLO button once again so its indicator is blinking, only Solo will be on.

### Solo

Even if you play a chord on the keyboard, only a single note will sound. The key you played last will sound.

### Legato

When you hold down one key and press another key, the sound will be maintained but the pitch will move to that of the second key you pressed. You will not hear any attack for the second key you pressed.

This produces an effect similar to the hammering-on/off technique used by a guitarist.

This is also suitable for simulating the trill techniques used on wind instruments or string instruments.



Legato: OFF

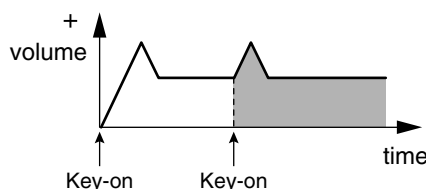

Legato: ON

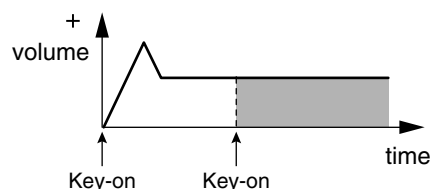

### Using legato and portamento simultaneously

If you turn portamento on when legato is already on (i.e., when the SOLO button’s indicator is lit), you’ll be able to control whether portamento is applied by the way you press the keys.

- **Hold down a key while pressing the next key**

Portamento will be applied.

The pitch of the currently sounding note will change smoothly to the pitch of the next key you pressed.

- **Release a key before you press the next key**

Portamento will not be applied.

When you press a key, the note will sound immediately at the corresponding pitch.

## Moving your hand to vary the pitch or volume (D BEAM)

By moving your hand over the **D Beam controller** located at the upper left of the keyboard, you can vary the pitch or volume of the sound according to the height of your hand.

### The usable range of the D Beam controller

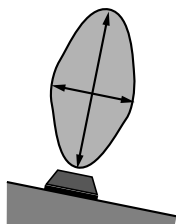

The diagram at left shows the usable range of the D Beam controller. Moving your hand outside this range will produce no effect.

Roland  
*SH-201*  
SYNTHESIZER

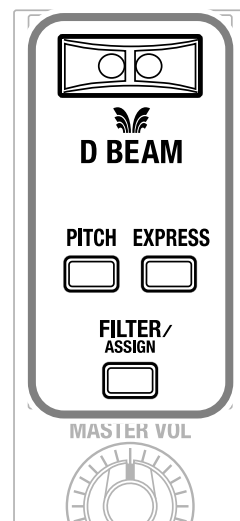
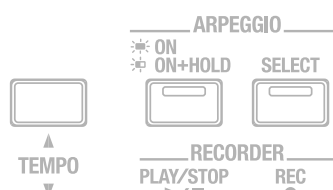

## Changing the pitch (PITCH)

Press the PITCH button located below the D Beam controller so it's lit.

When you hold down a key and move your hand up or down above the D Beam controller, the pitch will change.

Press the PITCH button once again so its light goes off, and the pitch will no longer be affected when you move your hand above the D Beam Controller.

## Changing the volume to add expression to your performance (EXPRESS)

Press the EXPRESS button located below the D Beam controller so it's lit.

When you hold down a key and move your hand up or down above the D Beam controller, the volume will change, letting you add expression to your performance.

Press the EXPRESS button once again so its light goes off, and the volume will no longer be affected when you move your hand above the D Beam controller.

### Active Expression

By using EXPRESS with a patch that is set to DUAL (p. 46), you can obtain an **Active Expression** effect that combines the two tones.

Only the UPPER tone will be heard when the volume is low, and the LOWER tone will be added as the volume increases.

If you want to use Active Expression, hold down the CANCEL button and press the ACTIVE EXPRESSION button, thus switching "ON" ACTIVE EXPRESSION, which is a PATCH COMMON parameter (p. 65).

## Changing the brightness or other aspects of the sound (FILTER/ASSIGN)

Press the FILTER/ASSIGN button located below the D Beam controller so it's lit.

When you hold down a key and move your hand up or down above the D Beam controller, the brightness of the sound (cutoff frequency of the filter; p. 35) will change.

Press the FILTER/ASSIGN button once again so its light goes off, and the brightness will no longer be affected when you move your hand above the D Beam controller.

### Selecting the parameter controlled by the D Beam

If you hold down the FILTER/ASSIGN button and move one of the top panel knobs, the D Beam controller will have the same function as that knob. At this time you can also choose the direction in which the knob will be moved.

For example, suppose that you hold down the FILTER/ASSIGN button while you turn the LFO RATE knob (p. 41) toward the right. Thereafter, when you move your hand closer to the D Beam controller while the FILTER/ASSIGN button is lit, the LFO speeds up, just as if you had moved the LFO RATE knob toward the right.

For details on the parameters that you can control, refer to **PATCH COMMON parameters** (p. 64) **CONTROLLER ASSIGN - D BEAM** (p. 65) and **D BEAM - D BEAM POLARITY** (p. 65).

\* To set the D Beam Controller's function to "FILTER" (changing the brightness of the sound), hold down the FILTER/ASSIGN button and turn the FILTER CUTOFF knob.

### Changing the sensitivity of the D Beam controller

If you're performing under strong direct sunlight or strong artificial illumination, the D Beam controller will be less sensitive.

In such cases, hold down the FILTER/ASSIGN button located below the D Beam controller and press one of the NUMBER buttons (1–8) located immediately above the keyboard to change the sensitivity of the D Beam controller.

The sensitivity setting is indicated by the number of NUMBER buttons that are lit red when you hold down the FILTER/ASSIGN button. The more NUMBER buttons that are lit red, the higher the sensitivity setting. Pressing a higher-numbered NUMBER button will increase the sensitivity.

## Sustaining the notes (Hold pedal)

If you connect a pedal switch (DP series; sold separately) to the rear panel PEDAL jack, the notes you play while holding down the pedal will continue sounding even if you take your hand off the keyboard. (This is called Hold.)

If you want to use a pedal switch as a hold pedal, hold down the CANCEL button and press the NUMBER 1 button before using it (**PEDAL ASSIGN** (p. 69)).

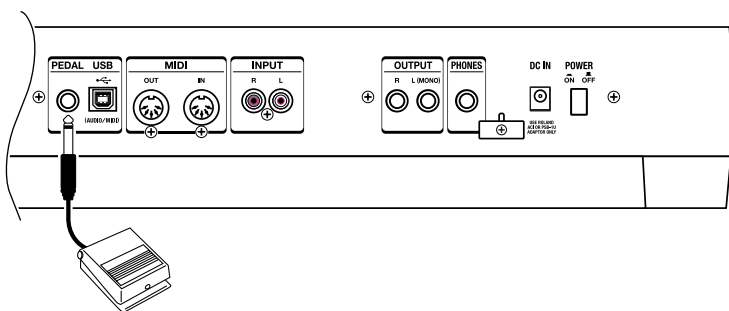

## Adding dynamics to your performance (Expression pedal)

If you connect an expression pedal (EV-5; sold separately) to the rear panel PEDAL jack, you can use the pedal to control the volume, adding dynamic expression to your performance.

If you want to use an expression pedal, hold down the CANCEL button and press the NUMBER 6 button before using it (**PEDAL ASSIGN** (p. 69)).

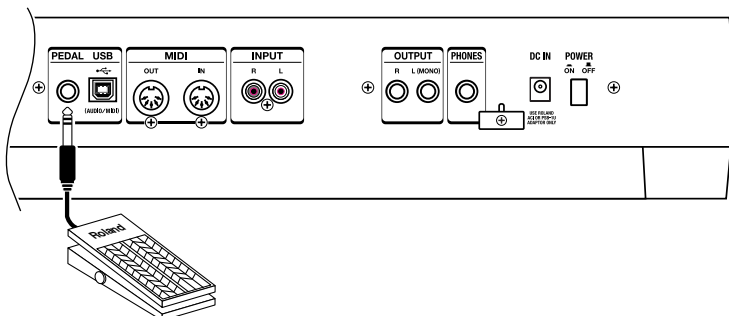

\* Use only the specified expression pedal (EV-5; sold separately). By connecting any other expression pedals, you risk causing malfunction and/or damage to the unit.

## Automatically playing arpeggios (ARPEGGIO)

The SH-201's arpeggiator lets you produce an arpeggio in the style you select simply by pressing a chord on the keyboard.

### Playing arpeggios (ON/HOLD)

- Press the ON button so its indicator is lit; the arpeggiator will be turned on.

When you press a chord on the keyboard, an arpeggio will play according to the settings stored in each patch.

- If you press the ON button once again so the button's indicator is blinking, the arpeggiator's Hold function is turned on.

When you press a chord on the keyboard, an arpeggio will play according to the settings stored in each patch, and will continue playing even if you take your hand off the keyboard. When you play a new chord, the arpeggio will also change.

To stop the arpeggio, turn off the arpeggiator.

To turn off the arpeggiator, press the ON button so its light goes off.

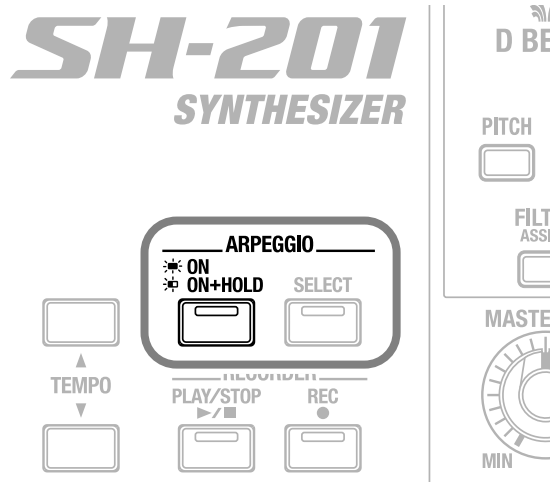

### Changing the arpeggio tempo

- **TEMPO buttons**

Use these to specify the tempo of the arpeggiator.

Press the upper (▲) button to make the tempo faster, or press the lower (▼) button to make the tempo slower.

- **TAP button**

You can set the tempo by pressing this button three or more times at quarter-note intervals of the desired tempo.

\* The TAP button's indicator will always be blinking at quarter-note intervals of the arpeggio and recorder tempo (p. 24).

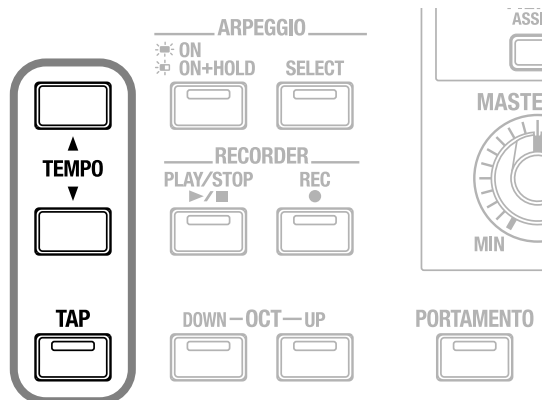

### Playing arpeggios via MIDI

Normally, you can use the arpeggiator only from the SH-201's own keyboard.

If you want to play the SH-201's arpeggiator via note messages from your external sequencer or sequencer software, set the KEYBOARD parameter (p. 69) **REMOTE KEYBOARD** to the "ON" setting.

## Selecting how the arpeggio is to sound (SELECT)

The SH-201 provides 32 ready-made variations of arpeggio, which are called “arpeggio templates.”

1

**Press the SELECT button so its indicator is lit.**

Now you can use the BANK buttons (A–D) and NUMBER buttons (1–8) to select an arpeggio template.

**SH-201**  
SYNTHESIZER

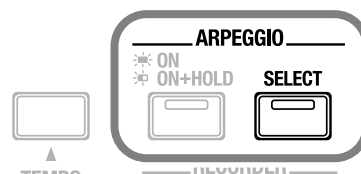

The arpeggio templates are organized into four groups, accessible using the BANK buttons, with eight templates at each.

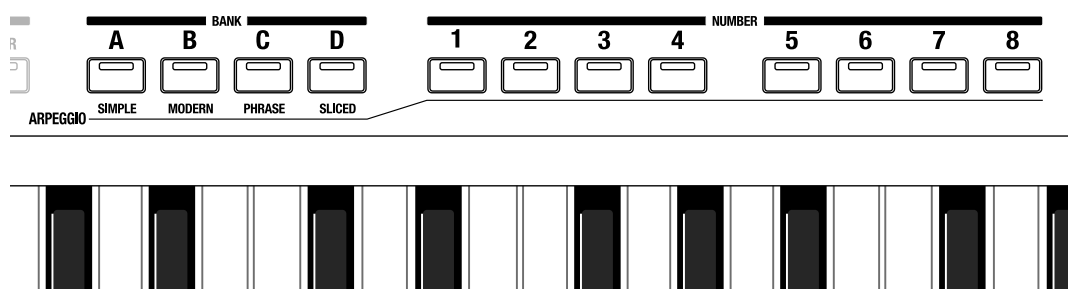

2

**Press the BANK button and NUMBER button of the arpeggio template you want to use.**

The arpeggio template for the buttons you pressed is selected.

3

**Press the SELECT button so its indicator is switched off.**

The BANK buttons and NUMBER buttons return to their normal function—patch selection.

\* You can also return to the normal state by pressing the blinking CANCEL button instead of pressing the SELECT button. (The arpeggio template selection is valid in this case as well.)

\* By using SH-201 Editor (p. 56) you can create your own original arpeggios that differ from these ready-made arpeggio templates. For details, refer to the **ARPEGGIO parameters** (p. 66).

## Recording your performance (RECORDER)

The Recorder function lets you record several measures of your keyboard performance or knob operations and play back this recording repeatedly.

The recorded performance is called a “phrase.” You can record up to eight phrases, each up to eight measures long.

The SH-201’s recorder does not record the actual “sound” you’re hearing; rather, it records performance data (MIDI messages) that provides an ongoing description of things, such as “which key was pressed, when, and how strongly.”

\* The patch you’re using, patch selections during the phrase, and tempo changes are not recorded.

### Recording

1

Press and release the REC button; the SH-201 enters REC standby mode.

The REC button’s indicator starts blinking, and the metronome begins sounding.

2

Specify the length of the phrase that you want to record.

In REC standby mode, the NUMBER buttons (1–8) are used to specify the length (number of measures) for the phrase. The number of lit buttons indicates the number of measures in the phrase.

To specify the number of measures, press the NUMBER button for the number of measures you want to record.

\* If you specify the length of the phrase to be recorded, all performance data previously recorded for that phrase will be erased.

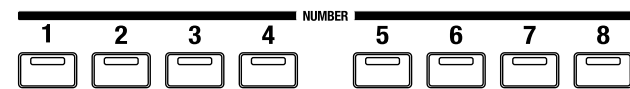

3

Press the PLAY/STOP button.

A one-measure (four-beat) count is sounded, then recording begins.

The blinking REC button’s indicator will change to steadily lit.

4

To stop recording, press the PLAY/STOP button once again.

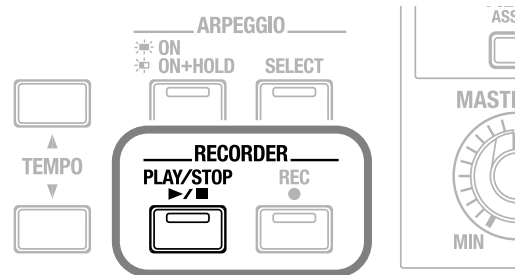
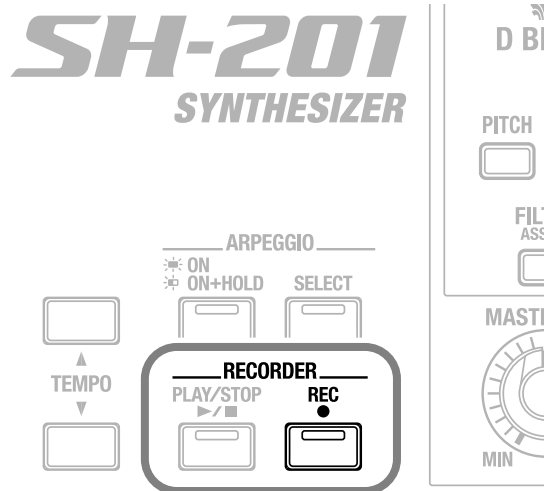

### Changing the tempo during recording

- **TEMPO buttons**

Use these to specify the tempo of the recorder/arpeggiator.

Press the upper (▲) button to make the tempo faster, or press the lower (▼) button to make the tempo slower.

- **TAP button**

You can set the tempo by pressing this button three or more times at quarter-note intervals of the desired tempo.

\* The TAP button’s indicator will always be blinking at quarter-note intervals of the recorder and arpeggio tempo (p. 22).

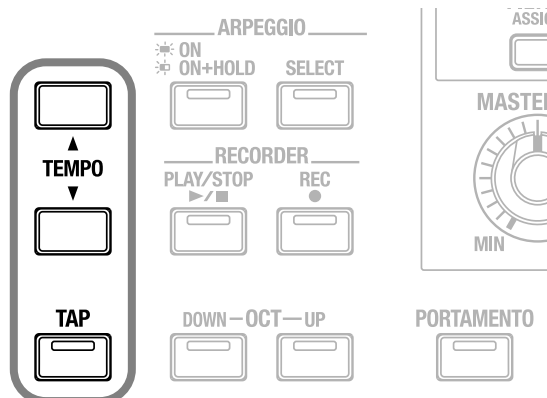



## Practicing while recording (Rehearsal)

Here's how you can temporarily stop recording while you're in the process of recording a phrase.

- 1 **While recording, press the REC button.**  
The REC button begins blinking. While it is blinking, your performance is not recorded.
- 2 **Press the REC button once again.**  
The REC button lights, and recording resumes.

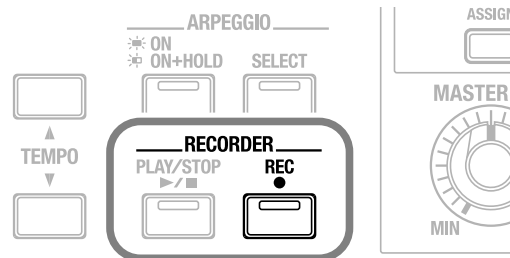

## Erasing a recorded note (Erase)

Here's how you can erase a note from the phrase you're recording.

- 1 **While recording, press the CANCEL button at the location of the note(s) you want to erase.**  
All previously recorded notes are erased from the region for which you continue to hold down the CANCEL button.
- 2 **When you reach the end of the region from which you want to erase notes, take your finger off of the CANCEL button.**  
Normal recording resumes.

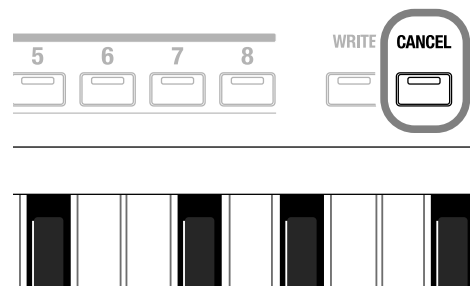

You can choose the type of data that will be recorded or erased by pressing one of the BANK buttons (A–D) during the REC standby state or while recording a phrase.

- **A (All):** All of the following (B, C, D) listed below (Default state)
- **B (Bender):** Pitch bender lever operations only
- **C (Controller):** Knob operations (only parameters in the table on p. 72)
- **D (notes):** Keyboard's performance data only

## Saving a recorded phrase

The phrase you recorded will be lost if you switch off the SH-201's power or select a different phrase. Once you've created a phrase you like, you can save it as follows.

- 1 **Hold down the REC button and press the WRITE button.**  
The indicator of the NUMBER button for the currently selected phrase begins blinking in red, while the indicators of the other seven NUMBER buttons light in green. The WRITE button's indicator will also blink.

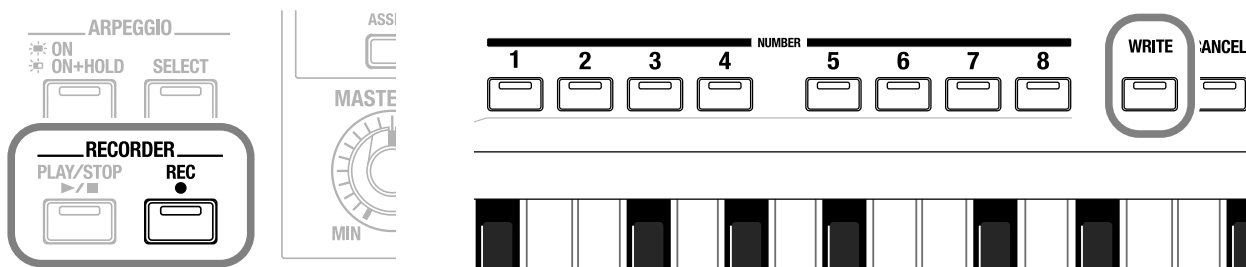

- 2 **Press the NUMBER button of the phrase number in which you want to save your recorded phrase.**  
The indicator of the NUMBER button you pressed begins blinking in red, and the indicator that was previously blinking now lights in green.
- 3 **Press the WRITE button.**  
The phrase will be saved. (The NUMBER buttons will revert to their usual role of selecting patches.)

\* If you decide to cancel this operation, press the CANCEL button at any point before you press the WRITE button in step 3.

## Playback

### Selecting the phrase you want to play

1

**Press and hold the REC button.**

While you hold down the REC button, the NUMBER buttons (1–8) function as phrase selection buttons.

The indicator of the NUMBER button for the currently selected phrase number blinks in green, while the indicators of the other seven NUMBER buttons light in green.

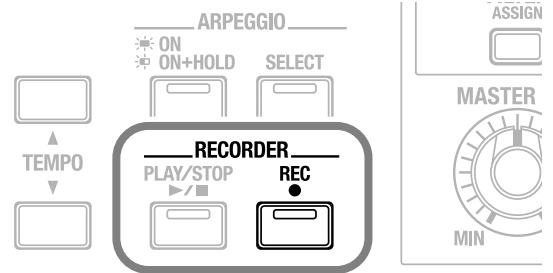
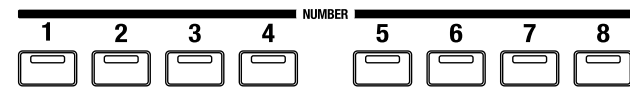

2

**Continue holding down the REC button, and press the NUMBER button for the phrase that you want to play.**

The indicator of the NUMBER button you pressed starts blinking in green, while the indicator that was previously blinking changes to steadily lit green.

3

**Release the REC button.**

You have now selected a phrase.

The NUMBER buttons will return to their usual function of selecting patches.

### Starting/stopping playback

4

**Press the PLAY/STOP button.**

Phrase playback begins.

The phrase will continue playing repeatedly until you press PLAY/STOP once again.

5

**Press the PLAY/STOP button once again to stop phrase playback.**

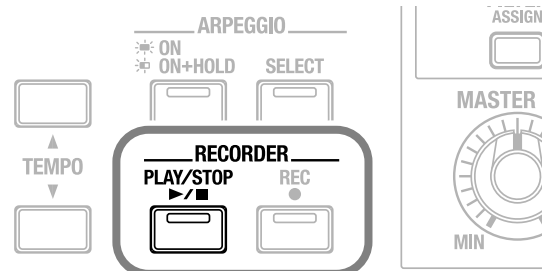

### Changing the tempo of the phrase

- **TEMPO buttons**

Use these to specify the tempo of the recorder/arpeggiator.

Press the upper (▲) button to make the tempo faster, or press the lower (▼) button to make the tempo slower.

- **TAP button**

You can set the tempo by pressing this button three or more times at quarter-note intervals of the desired tempo.

\* The TAP button's indicator will always be blinking at quarter-note intervals of the recorder and arpeggio tempo (p. 22).

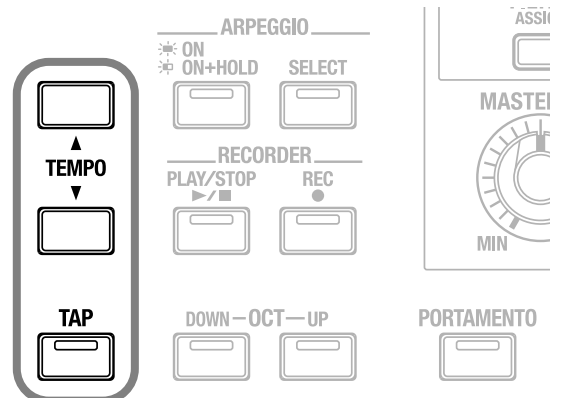

# Creating sounds

## How sounds are created

The following diagram shows the basic process by which the SH-201 creates sounds.

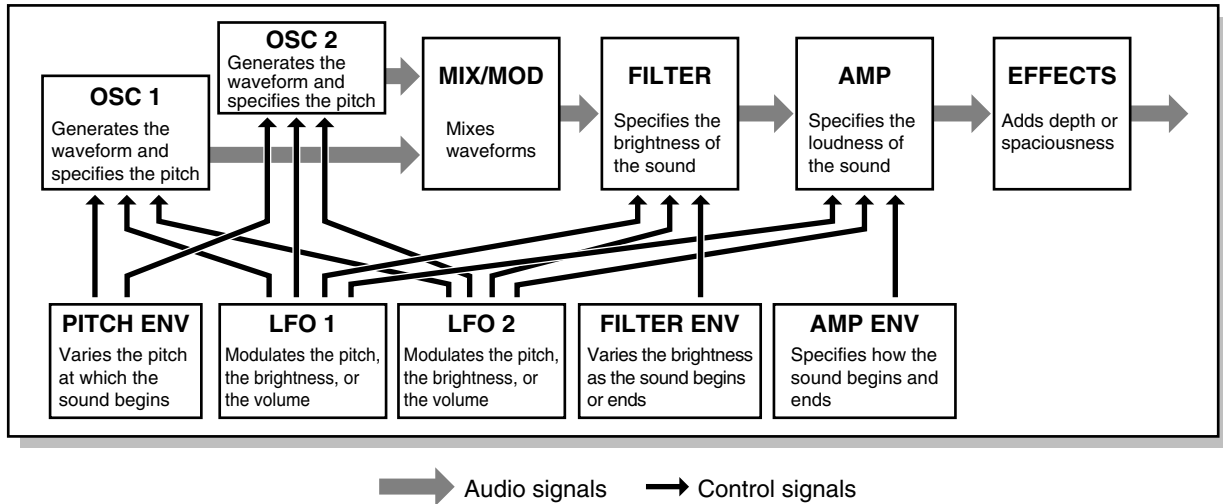

### The three elements of sound

There are three important elements that determine the character of a sound; the pitch, the brightness, and the volume. On the SH-201, these three elements are specified by the following sections.

- **Pitch:** **OSC (oscillator; p. 28)**
- **Brightness:** **FILTER (filter; p. 34)**
- **Volume:** **AMP (amplifier; p. 38)**

First, use the OSC section to specify the pitch. Next, use the FILTER section to specify the brightness. Finally, use the AMP section to specify the volume. This is the basic procedure for creating a sound.

In actuality, the brightness of the sound is dramatically affected by the waveform generated by the OSC section, but the process is as described above.

### Time-varying change in the sound (Envelope)

The OSC, FILTER, and AMP sections can vary the pitch, brightness, and volume of the sound over time.

For example, you can make the pitch fall momentarily at the beginning of each note, or make the volume of each note gradually increase.

The way in which some aspect of a note changes over time is called the “envelope.” The envelope is specified by the following sections.

- **Pitch:** **PITCH ENV** (pitch envelope; p. 31)
- **Brightness:** **FILTER ENV** (filter envelope; p. 37)
- **Volume:** **AMP ENV** (amp envelope; p. 38)

### Cyclic change in the sound (Modulation)

The OSC, FILTER, and AMP sections can also be controlled by an LFO (Low Frequency Oscillator; p. 40) to cyclically vary aspects of the sound such as pitch (producing vibrato) or volume (producing tremolo).

Cyclic change applied to the pitch, tone, or volume in this way is called “modulation.”

The SH-201 has two LFO units, allowing you to simultaneously apply modulation of differing speeds and waveforms.

A patch suitable as a starting point for creating sound “from scratch” is provided at the end of preset group bank D. Use this patch as desired.

## Specifying the waveform and pitch (OSC)

The OSC (oscillator) section produces the waveform that is the basis of the sound.

Selecting a waveform will also determine the pitch.

The SH-201 has two oscillators; OSC 1 and OSC 2.

You can use these separately, or together to create rich or complex sounds.

For details on how you can combine the two oscillators, refer to **Combining waveforms to create rich or metallic sounds (MIX/MOD)** (p. 32).

### OSC 1 (oscillator 1) button/OSC 2 (oscillator 2) button

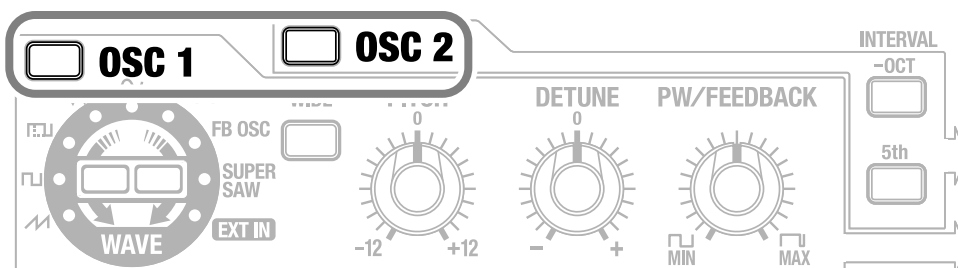

Use these buttons to specify whether you're making settings for OSC 1 or OSC 2.

Press the button for the desired oscillator; it will light.

### WAVE buttons

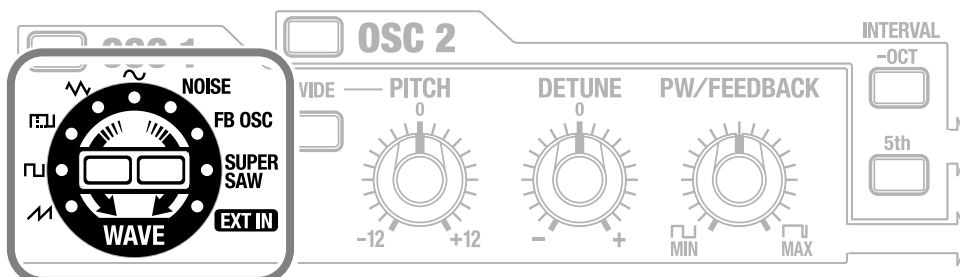

Use these buttons to select the waveform that is the basis of the sound. One of the indicators will light to indicate the waveform that's selected. Press the right button to move clockwise through the selections, or the left button to move counterclockwise.

Lit indicator	Description
(Sawtooth wave)	This waveform contains the fundamental frequency (sine wave) plus all of its integer multiples (overtones) at a fixed proportion.
(Square wave)	This waveform contains the fundamental frequency (sine wave) plus its odd-numbered integer multiples (overtones) at a fixed proportion.
(Asymmetrical square (pulse) wave)	The overtone structure will change significantly depending on the width of the upper portion (pulse width, p. 30) of the waveform.
(Triangle wave)	This waveform contains the fundamental frequency (sine wave) plus its even-numbered integer multiples (overtones) at a fixed proportion.
(Sine wave)	A waveform with no overtones (harmonics). It consists of only one single frequency.
NOISE	A waveform containing all frequencies. Use this for percussion sounds or sound effects.
FB OSC (Feedback oscillator)	Produces a tone containing high overtones, similar to feedback on a guitar. Ideal for creating aggressive, cutting sounds.
SUPER SAW	A sound resembling seven sawtooth waves played simultaneously. Pitch-shifted sounds are added to a core sound. Ideal for creating string sounds and other rich tones.
EXT IN (External In)	This plays the sound from the audio source connected to the rear panel INPUT jacks. Refer to p. 52. * There will be no sound if nothing is connected to the INPUT jacks or if you have turned down the volume of the connected source or the INPUT VOL (p. 49).

## PITCH knob

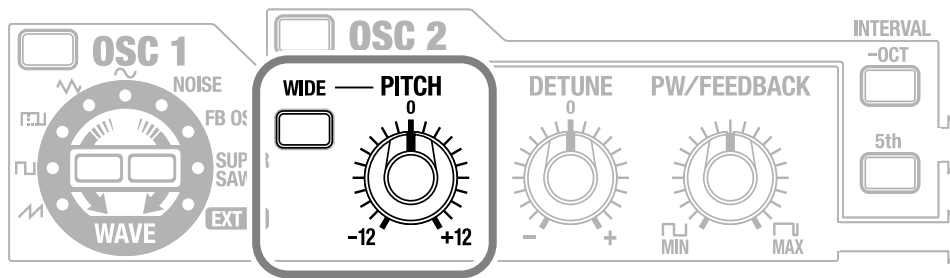

This knob specifies the pitch.

- Turning the knob toward the right raises the pitch in semitone steps. Turning the knob all the way raises the pitch one octave above the center setting.
- Turning the knob toward the left lowers the pitch in semitone steps. Turning the knob all the way lowers the pitch one octave below the center setting.

### WIDE button

This button expands the range of the PITCH knob by a multiple of three.

If you press the WIDE button so it's lit, the PITCH knob will have a range of +/-3 octaves.

If you press the WIDE button once again so the light is off, the PITCH knob will return to a range of +/-1 octave.

### Using the PITCH knob

For example, by setting the OSC 2 pitch five semitones (a perfect fourth) below OSC 1, you can play a single key to produce a heavy sound similar to when two adjacent strings are played at the same fret on strings 3–6 of a guitar.

You can also use the PITCH setting to shift the sound to the range in which you'll usually be playing it. For example, if you're creating a sound that's normally played in a low range, such as synth bass, you can set PITCH one octave down.

## DETUNE knob

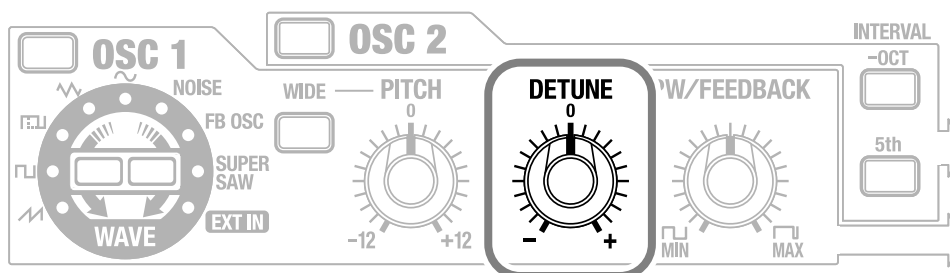

This knob provides a finer pitch adjustment than the PITCH knob.

You can use it to create a slight difference in the pitches of OSC 1 and OSC 2 so that the sound is slightly modulated, producing a richer tone (Detune effect).

- Turning the knob toward the right raises the pitch. Turning the knob all the way raises the pitch 50 cents above the center setting.
- Turning the knob toward the left lowers the pitch. Turning the knob all the way lowers the pitch 50 cents below the center setting.

### What is a “cent”?

One cent is 1/100th of a semitone. Fifty cents is half a semitone.

### PW/FEEDBACK (Pulse Width/Feedback) knob

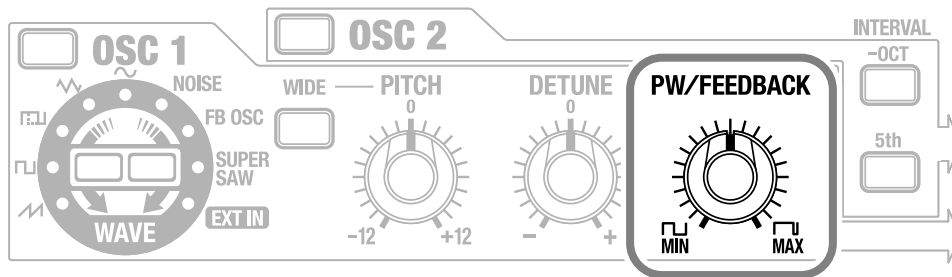

This knob is effective only if specific waveforms are selected by the WAVE buttons (p. 28).

#### When (asymmetrical square (pulse) wave) is selected

The knob specifies the width of the high portion of the waveform (i.e., the pulse width) as a percentage of the entire cycle.

- Turning the knob toward the left narrows the pulse width, approaching a square wave (  , pulse width = 50%).
- Turning the knob toward the right broadens the pulse width, producing a distinctive sound.

#### When FB OSC is selected

The knob specifies the amount of output sound that is to be returned (fed back) to the input.

Turning the knob toward the right increases the feedback, producing more overtones and making the sound more aggressive.

#### When SUPER SAW is selected

The knob specifies the amount of pitch spread between the seven sawtooth waves layered within a single oscillator. Turning the knob toward the right will increase the pitch spread.

(In this case, the DETUNE knob will adjust all seven sawtooth waves by the same pitch amount.)

### INTERVAL buttons

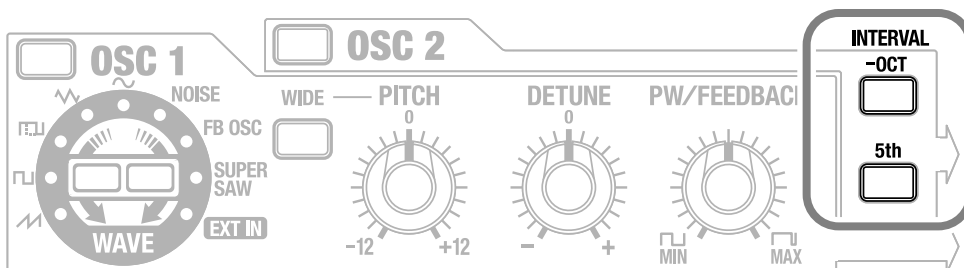

#### **-OCT (minus octave) button**

This button lowers the OSC 2 pitch one octave below that of OSC 1.

Pressing a single key will produce a rich sound, as though you had also played another key one octave below.

#### **5th button**

If you press this button, the OSC 2 pitch will be seven semitones (a perfect fifth) higher than OSC 1.

Playing a single key will produce a fifth chord, creating a heavy sound.

\* If you press the -OCT button and the 5th button simultaneously, the OSC 2 pitch will be the same as the OSC 1 pitch.

\* Parameters other than pitch will not change.

## PITCH ENV (pitch envelope) sliders

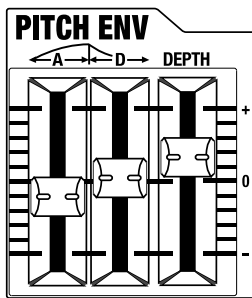

Brass instruments such as trumpet sometimes produce a slight shift in pitch when you begin blowing a note. You can use the pitch envelope to create this type of change in pitch over time.

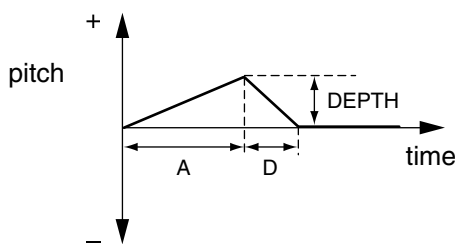

### A (attack time) slider

Specifies the time from when you play a key until the pitch reaches the highest (or lowest) point.

Moving the slider upward lengthens the time, and moving it downward shortens the time.

### D (decay time) slider

Specifies the time from when the pitch reaches its highest (or lowest) point until it returns to the pitch of the key you pressed.

Moving the slider upward lengthens the time, and moving it downward shortens the time.

### DEPTH slider

Specifies the direction and amount of the pitch change.

- Moving the slider upward (in the “+” direction) causes the pitch to initially rise, and then return to the pitch of the key you pressed. Moving the slider farther will produce a greater rise in pitch.
- Moving the slider downward (in the “-” direction) causes the pitch to initially fall, and then return to the pitch of the key you pressed. Moving the slider farther will produce a greater fall in pitch.

\* DEPTH can be set independently for OSC 1 and OSC 2. For example, you could leave the OSC 1 pitch fixed, and change the pitch only for OSC 2.

When the OSC 1 button is lit, moving the DEPTH knob will change the OSC 1 DEPTH. When the OSC 2 button is lit, moving the DEPTH knob will change the OSC 2 depth.

### Using PITCH ENV

If you want the sound to rise briefly, as at the beginning of a trumpet note, set A and D to very short times and move the DEPTH slightly in the “+” direction.

By setting A to the shortest setting (with the slider all the way down), D to a somewhat longer setting, and DEPTH all the way up, you can create a down-swooping pitch similar to the electronic drums that were popular in the 1980’s.

# Combining waveforms to create rich or metallic sounds (MIX/MOD)

You can combine the sounds of OSC 1 and OSC 2 to create more complex sounds.

## TYPE button

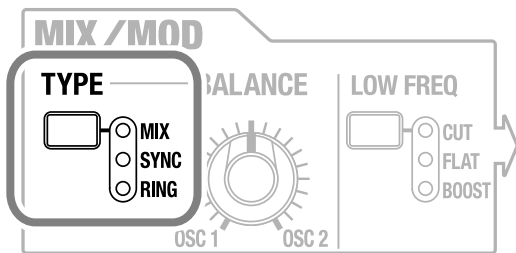

This button selects how OSC 1 and OSC 2 are to be combined.

Press the button to light the indicator for the desired combination.

Pressing the button successively cycles you through the settings in this order: MIX -> SYNC -> RING -> MIX -> ...

- **MIX**

The sounds of OSC 1 and OSC 2 will be heard together.

You can create a rich sound by slightly shifting the pitch of the two oscillators or by layering different waveforms.

- **SYNC (oscillator sync)**

OSC 1 will be forced to restart its cycle in synchronization with the beginning of each OSC 2 cycle, generating a complex waveform.

This is effective when the OSC 1 pitch is higher than the OSC 2 pitch.

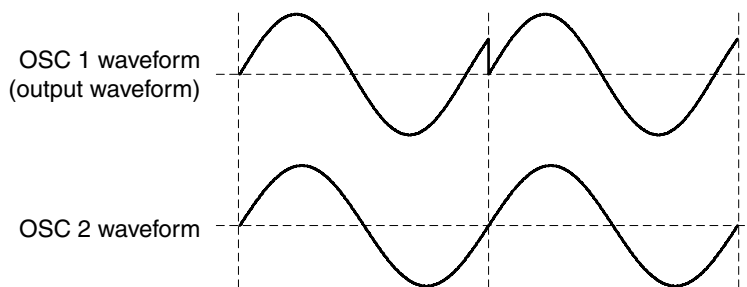

- **RING (ring modulator)**

OSC 1 and OSC 2 will be multiplied to create a complex, metallic-sounding tone reminiscent of a bell.

It will be easier to produce a ring modulator effect if you set OSC 1 and OSC 2 to different pitches.

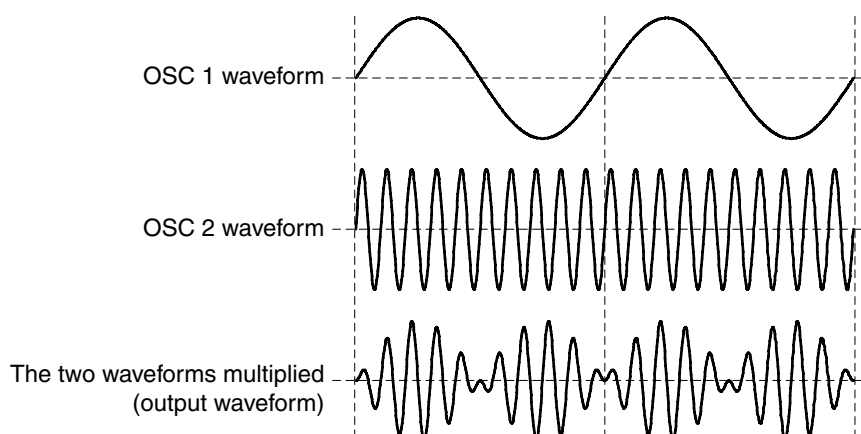



## BALANCE knob

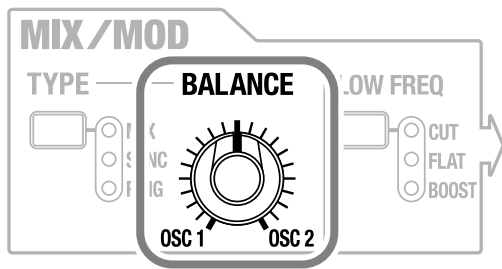

This knob adjusts the volume balance of OSC 1 and OSC 2.

- Turning the knob toward the left increases the volume of OSC 1.  
If you turn the knob all the way to the left, only the sound of OSC 1 will be output, and OSC 2 will not be heard. When TYPE is “RING,” the sound to which ring modulation is applied will be output.
- Turning the knob toward the right increases the volume of OSC 2.  
If you turn the knob all the way to the right, only the sound of OSC 2 will be output, and OSC 1 will not be heard.

\* If you find it difficult to distinguish the oscillator sync or ring modulator effect, turn the BALANCE knob toward the left.

### NOTE

Immediately after you’ve selected the PRESET D-8 patch, you will be hearing only the sound of OSC 1 (a state in which the BALANCE knob is turned all the way to the left). If you want OSC 2 to be heard, adjust the BALANCE knob.

## LOW FREQ (low frequency) button

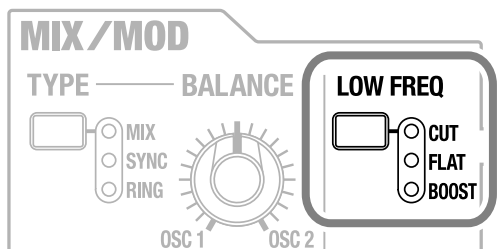

This button selects whether the low frequency range will be boosted to produce a heavy sound or cut to produce a lighter sound.

Press the button to select the indicator for the desired setting.

Pressing the button successively cycles you through the settings in this order: CUT -> FLAT -> BOOST -> CUT -> ...

- **CUT**

The low frequency range will be cut, producing a lighter sound.

Since this will make the high frequency range more prominent, it may make the sound crisper.

- **FLAT**

The low frequency range will neither be boosted nor cut.

- **BOOST**

The low frequency range will be boosted, producing a heavier sound.

This setting is useful when you’re creating a synth bass sound or a rich strings sound.

# Specifying the brightness and thickness of the sound (FILTER)

## TYPE button

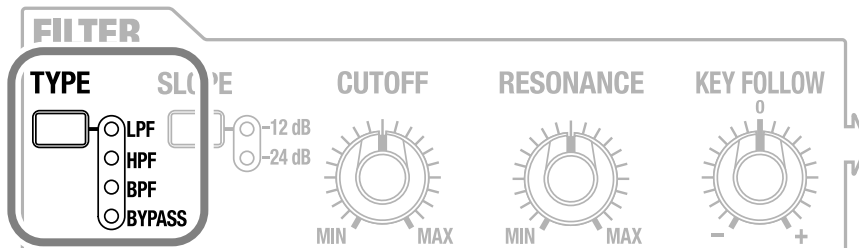

This button selects the type of filter that is applied to the waveform.

Press the button so the indicator for the desired filter is lit.

Pressing the button successively cycles you through the settings in this order: LPF -> HPF -> BPF -> BYPASS -> LPF -> ... .

## Filter types

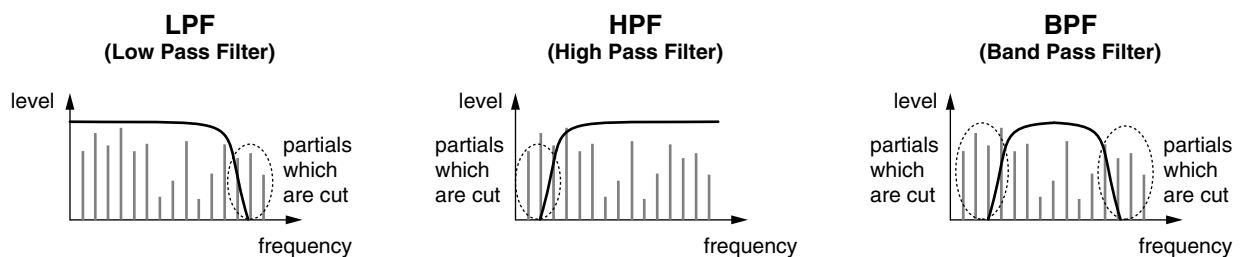

- **LPF (Low Pass Filter)**

This cuts the frequency region above the cutoff frequency, making the sound more mellow.

This is the most commonly used filter.

- **HPF (High Pass Filter)**

This cuts the frequency region below the cutoff frequency, emphasizing the high-frequency region.

You can use this when you want to create percussion instrument sounds with a distinctive high range.

- **BPF (Band Pass Filter)**

This passes only the frequencies in the region of the cutoff frequency, and cuts the remaining frequency regions.

You can use this to create distinctive sounds.

If you select this filter type when you've selected "NOISE" as the OSC waveform, you will hear only a limited region of the frequency components of the noise waveform; this lets you play notes that have a sense of pitch.

- **BYPASS**

Bypasses the filter. The unfiltered waveform of the oscillator will be output.

## SLOPE button

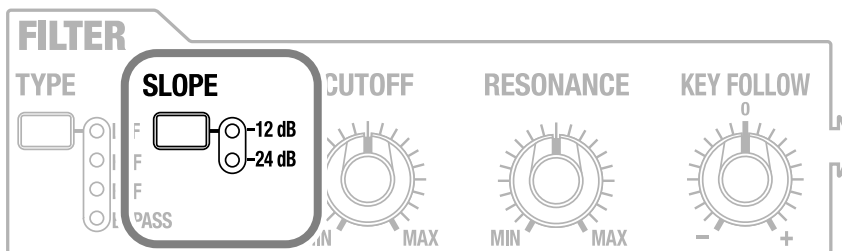

This button selects the slope (steepness) of the filter.

Press the button so the indicator for the desired slope is lit.

Each time you press the button you can alternate between the -12 dB and -24 dB setting.

- **-12 dB**

The filter slope will be gentle, allowing some of the sound near the cutoff frequency to remain.

- **-24 dB**

The filter slope will be steep, cutting most of the sound immediately above (or below) the cutoff frequency.

### Example: LPF (Low Pass Filter) SLOPE settings

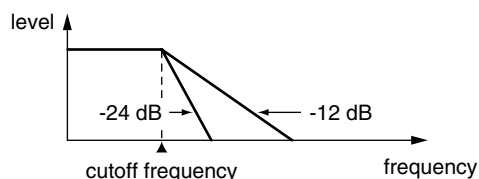

## CUTOFF knob

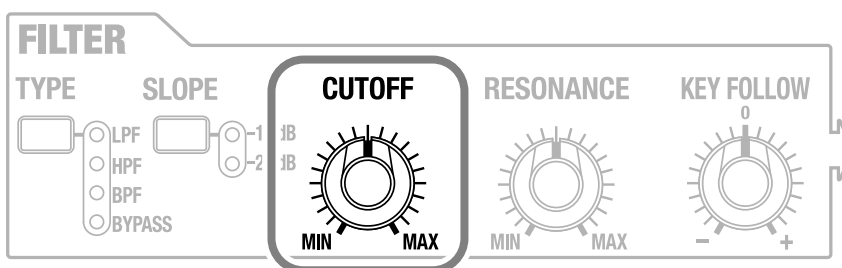

This specifies the **cutoff frequency** of the filter.

### When the filter TYPE is “LPF”

Turning the knob toward the right brightens the sound, while turning it toward the left darkens (mellows) the sound.

### When the filter TYPE is “HPF”

Turning the knob toward the right will make the sound lighter (less thick), and turning it toward the left will make the sound heavier (thicker).

### When the filter TYPE is “BPF”

Turning the knob toward the right will allow a higher range of frequencies to be heard, and turning it toward the left will allow a lower range of frequencies to be heard.

\* When the filter TYPE is “BYPASS,” turning the knob will not affect the sound.

## RESONANCE knob

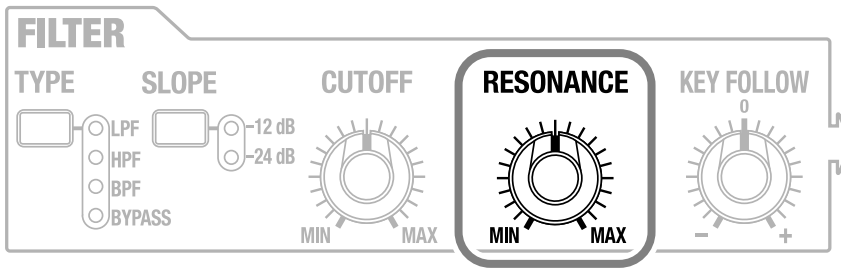

This boosts the sound in the region near the filter cutoff frequency, adding a distinctive character to the sound.

- Turning the knob toward the right will boost the sound in the region near the cutoff frequency, producing a more strongly distinctive sound.
- Turning the knob toward the left will remove the boost from the sound in the region near the cutoff frequency, producing a less distinctive sound.

\* When the filter TYPE is "BYPASS," turning the knob will not affect the sound.

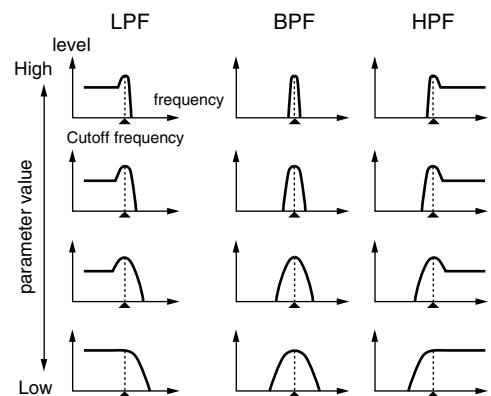

### NOTE

If you turn the RESONANCE knob far toward the right, oscillation may occur and the sound may not stop at all. To stop the oscillation, turn the RESONANCE knob toward the left.

## KEY FOLLOW knob

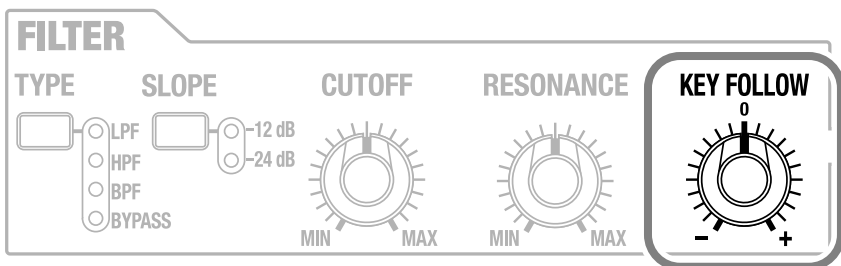

This causes the filter cutoff frequency to change according to the key you play.

- Turning the knob toward the right will cause the cutoff frequency to rise as you play upward on the keyboard and fall as you play lower on the keyboard.
- Turning the knob toward the left will cause the cutoff frequency to fall as you play upward on the keyboard and rise as you play lower on the keyboard.
- At the center position (0), the cutoff frequency will not be affected by the position of the key you play.

\* When the filter TYPE is "BYPASS," turning the knob will not affect the sound.

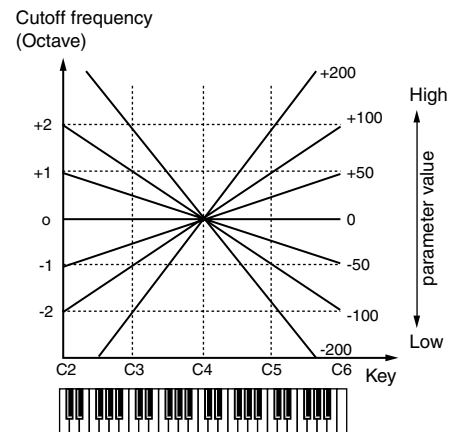

## FILTER ENV (filter envelope) sliders

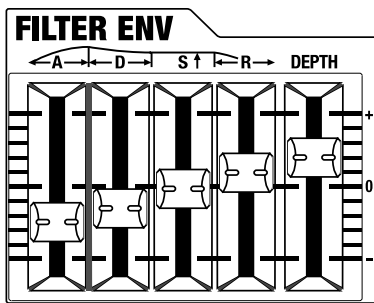

On instruments such as piano, each note begins with a bright tone, and gradually darkens (becomes more mellow) as the note decays.

The filter envelope lets you create time-varying tonal changes of this type.

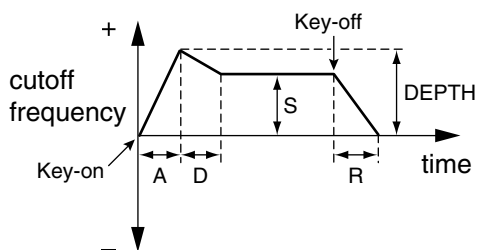

### A (attack time) slider

Specifies the time from when you press the key until the cutoff frequency reaches its highest (or lowest) point.

Moving the slider upward lengthens the time, and moving it downward shortens the time.

### D (decay time) slider

Specifies the time from when the cutoff frequency reaches its highest (or lowest) point until it falls to the sustain level.

Moving the slider upward lengthens the time, and moving it downward shortens the time.

### S (sustain level) slider

Specifies the cutoff frequency that is to be maintained from when the attack time and decay time have elapsed until you release the key.

Moving the slider upward raises the cutoff frequency (or lower it if the DEPTH is "-").

### R (release time) slider

Specifies the time from when you release the key until the cutoff frequency falls to its minimum level.

Moving the slider upward lengthens the time, and moving it downward shortens the time.

### DEPTH slider

Specifies the direction and amount in which the cutoff frequency will change.

- Moving the slider upward (in the "+" direction) causes the cutoff frequency to change in the upward direction. The higher you move the slider upward, the more the cutoff frequency will rise.
- Moving the slider downward (in the "-" direction) causes the cutoff frequency to change in the downward direction. The lower you move the slider downward, the more the cutoff frequency will fall.

## Specifying how the sound begins and ends (AMP)

### LEVEL knob

This specifies the volume. Turn the knob toward the right to increase the volume, or toward the left to decrease the volume.

If you turn the knob all the way to the left, there will be no sound.

### OVERDRIVE button

Refer to **Creating a powerful, distorted sound (OVERDRIVE)** (p. 39).

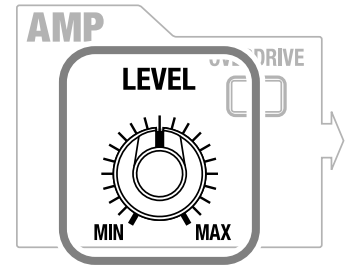

### AMP ENV (amp envelope) sliders

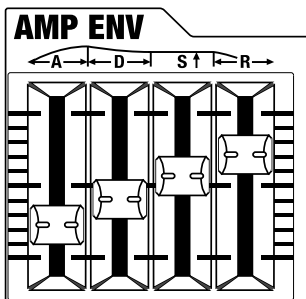

When you play a note on a piano, the sound begins the instant you press the key, and gradually diminishes over time. In contrast, when you play a note on an organ, the sound stays at a constant volume as long as you hold down the key.

The amp envelope lets you create these types of time-varying change in volume.

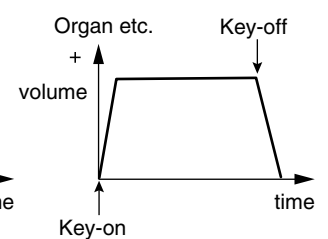
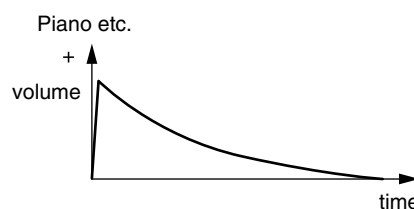
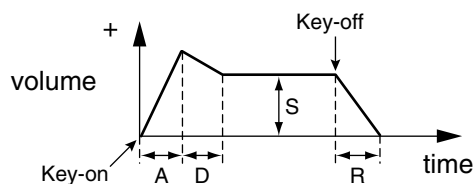

### A (attack time) slider

Specifies the time from when you press the key until the maximum volume is reached.

Moving the slider upward lengthens the time, and moving it downward shortens the time.

### D (decay time) slider

Specifies the time from when the maximum volume is reached until the volume falls to the sustain level.

Moving the slider upward lengthens the time, and moving it downward shortens the time.

### S (sustain level) knob

Specifies the volume that is to be maintained after the attack time and decay time have elapsed until you release the key.

Moving the slider upward increases the sustain level.

### R (release time) knob

Specifies the time from when you release the key until the volume falls to the minimum level.

Moving the slider upward lengthens the time, and moving it downward shortens the time.

## Creating a powerful, distorted sound (OVERDRIVE)

Overdrive gives the sound a distorted character similar to the vacuum tube amplifier distortion often used with an electric guitar.

This will generate additional overtones, making the sound thicker and more powerful.

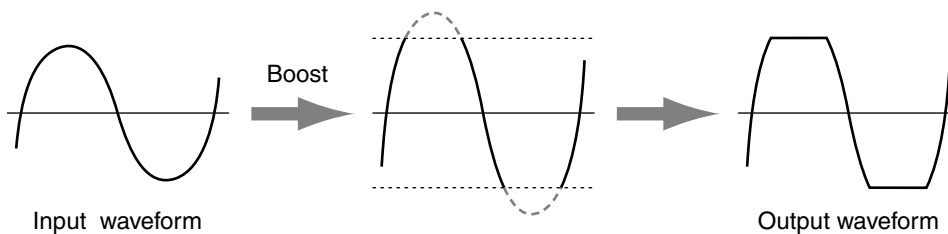

### OVERDRIVE button

When you press this button so it's lit, overdrive will be turned on, causing the sound to distort.

#### Changing the depth of distortion

You can hold down the OVERDRIVE button and turn the LEVEL knob to adjust the depth of the distortion.

Turning the LEVEL knob toward the right will make the distortion more intense.

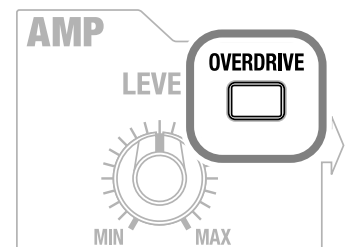

*\* Even when overdrive is turned on, the LEVEL knob will operate in the same way as when overdrive is turned off. Turning the LEVEL knob (without pressing the OVERDRIVE button) will adjust the volume.*

# Modulating the sound (LFO)

By using an LFO (Low Frequency Oscillator) waveform to control the OSC 1/2 PITCH, the FILTER CUTOFF, or the AMP LEVEL, you can apply cyclic change (modulation) to the pitch, brightness, or volume.

The SH-201 has two LFOs; LFO 1 and LFO 2.

You can use one LFO to control up to two destinations (DESTINATION 1 and DESTINATION 2, p. 42 and p. 43) such as pitch or volume.

## LFO 1 button/LFO 2 button

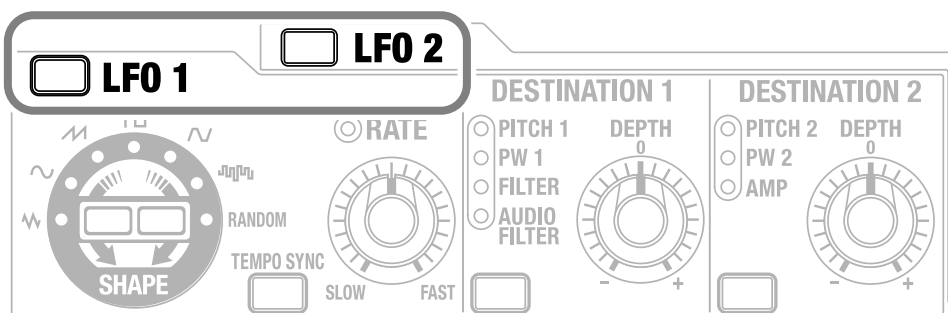

Use these buttons to specify whether you're making settings for LFO 1 or LFO 2. Press the button for the desired LFO; it will light.

## SHAPE buttons



Use these buttons to select the LFO waveform. One of the indicators will light to indicate the waveform that's selected. Press the right button to move clockwise through the selections, or the left button to move counterclockwise.

Lit indicator	Waveform
	Triangle wave
	Sine wave
	Sawtooth wave
	Square wave
	Trapezoidal wave
	Sample & hold wave (LFO value is changed one time per cycle)
RANDOM	Random wave



## RATE knob

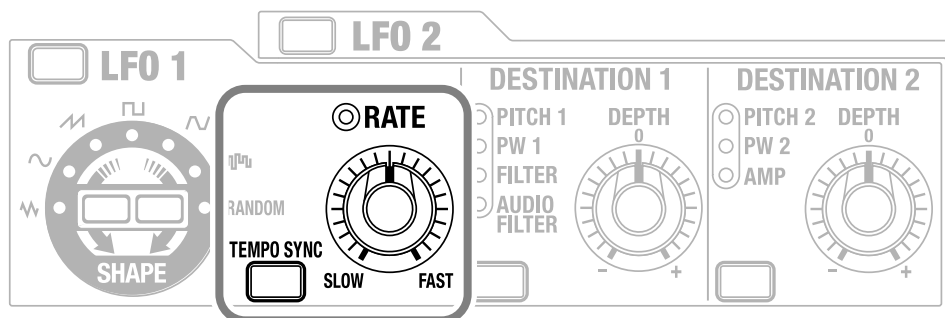

This specifies the speed of LFO modulation.

Turning the knob toward the right speeds up the modulation, while turning it toward the left slows the modulation down.

\* The indicator above the RATE button will blink at the speed (cycle) of the LFO.

### TEMPO SYNC button

You can specify the LFO RATE as the length of a note value relative to the tempo of the arpeggiator or recorder. When you press the TEMPO SYNC button so it's lit, and turn the RATE knob, the LFO speed (cycle) will change in step-wise fashion that matches the note lengths.

If you press the TEMPO SYNC button once again so its light is turned off, the LFO speed will change continuously.

\* The TAP button (p. 22, p. 26) indicator blinks at quarter note intervals of the arpeggio and recorder tempo.

### note:

- x 16 (Whole note x 16),   ◦ x 12 (Whole note x 12),   ◦ x 8 (Whole note x 8),   ◦ x 4 (Whole note x 4),
- x 2 (Whole note x 2),   ◦ (Whole note),   ♩ (Dotted half note),   ◻ (Whole-note triplet),
- ♩ (Half note),   ♪ (Dotted quarter note),   ♪♩ (Half-note triplet),   ♩ (Quarter note),
- ♩. (Dotted eighth note),   ♪♩♩ (Quarter-note triplet),   ♩ (Eighth note),   ♩. (Dotted sixteenth note),
- ♩♩♩ (Eighth-note triplet),   ♩ (Sixteenth note),   ♩♩♩ (Sixteenth-note triplet),   ♩ (Thirty-second note)

### Speed and waveform of the vibrato applied by the modulation lever

The LFO 2 SHAPE and RATE determine the speed and waveform of the vibrato that is applied when you move the modulation lever (p. 18) away from yourself.

## DESTINATION 1



This specifies the parameter that will be modulated by the LFO.

Press the button so that the indicator for the desired destination is lit.

Each press of the button takes you to next choice among the available LFO destinations: PITCH 1 -> PW 1 -> FILTER -> AUDIO FILTER -> PITCH 1 -> ... .

Lit indicator	What is being modulated
<b>PITCH 1</b>	The OSC 1 PITCH (Pitch, p. 29) will be modulated (producing vibrato).
<b>PW 1</b>	The OSC 1 PW/FEEDBACK knob setting will be modulated. If you select  as the OSC 1 waveform, this will produce an effect known as PWM (Pulse Width Modulation).
<b>FILTER</b>	The FILTER CUTOFF (cutoff frequency, p. 35) will be modulated (producing a wah effect).
<b>AUDIO FILTER</b>	The AUDIO FILTER's CUTOFF (cutoff frequency, p. 51) will be modulated.

### DEPTH knob

This specifies the depth of modulation that will be applied to the parameter you selected for DESTINATION 1.

- Turning the knob toward the right will deepen the modulation.
- At the center position (0) of the knob there will be no modulation.
- Turning the knob toward the left will vertically invert the direction of the modulation produced by the LFO waveform.

\* LFO 1 and LFO 2 each have a DESTINATION 1 and a DESTINATION 2.

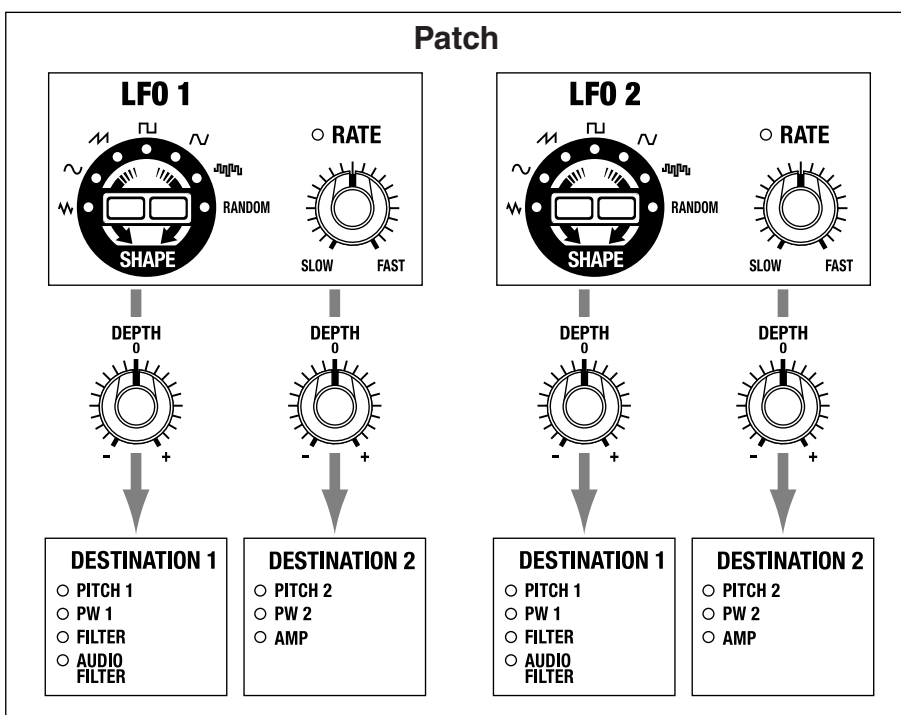

## DESTINATION 2

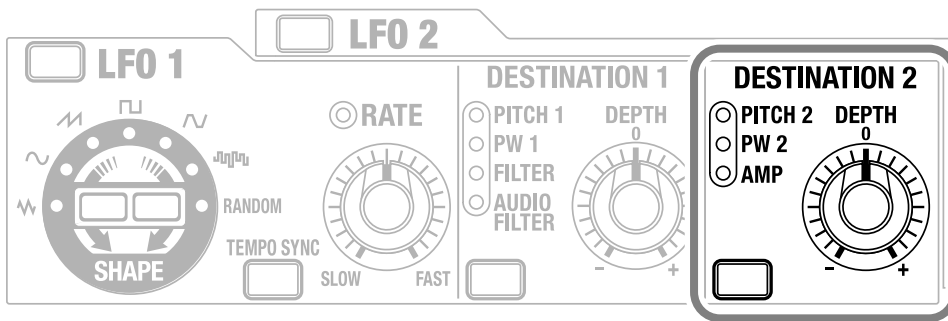

This specifies the parameter that will be modulated by the LFO.

Press the button so that the indicator for the desired destination is lit.

Each press of the button takes you to next choice among the available LFO destinations: PITCH 2 -> PW 2 -> AMP -> PITCH 2 -> ...

Lit indicator	What is being modulated
<b>PITCH 2</b>	The OSC 2 PITCH (Pitch, p. 29) will be modulated (producing vibrato).
<b>PW 2</b>	The OSC 2 PW/FEEDBACK knob setting will be modulated. If you select  as the OSC 2 waveform, this will produce an effect known as PWM (Pulse Width Modulation).
<b>AMP</b>	The AMP LEVEL (volume, p. 38) will be modulated (producing tremolo).

### DEPTH knob

This specifies the depth of modulation that will be applied to the parameter you selected for DESTINATION 2.

- Turning the knob toward the right will deepen the modulation.
- At the center position (0) of the knob there will be no modulation.
- Turning the knob toward the left will vertically invert the direction of the modulation produced by the LFO waveform.

\* You can vertically invert the direction of the modulation by turning the DEPTH knob in the opposite direction for DESTINATION 1 and DESTINATION 2.

**Example: When LFO SHAPE is **

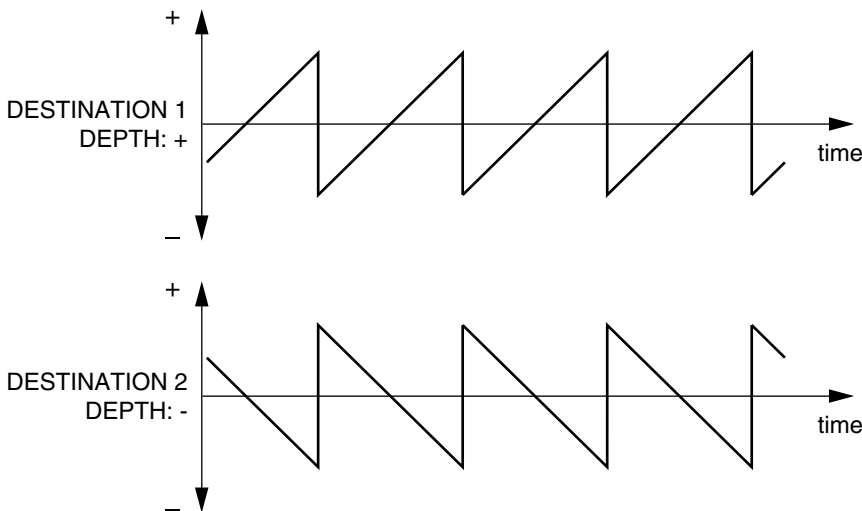

# Adding depth and spaciousness to the sound (EFFECTS)

You can use effects to add depth and spaciousness to the sound.

The SH-201 provides two effects; DELAY (modulation delay) and REVERB.

### Effect types

- **DELAY:** This produces a delayed repeat like an echo. You can also add modulation to the delayed sound.
- **REVERB:** Adds the reverberation that is characteristic of a performance in a hall or room.

\* You can change the speed and depth of the modulation applied to the delay sound (**MODULATION RATE, MODULATION DEPTH** (p. 63)).

## EDIT button

Use this button to specify whether you're editing DELAY or REVERB.

Press the button so the indicator for the effect you want to edit is lit.

Pressing the button toggles you between DELAY and REVERB.

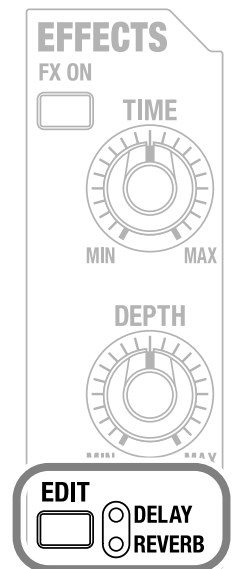

## FX ON (effect on) button

This button specifies whether DELAY or REVERB will be used.

If you press this button so its indicator is lit, the corresponding effect will be on.

- \* You can turn on just DELAY or REVERB by itself, or turn both on simultaneously.
- \* The effect on/off setting is shared by the UPPER tone and LOWER tone (p. 46). If you want to apply an effect to just one tone, turn the EFFECTS DEPTH knob (p. 45) all the way to the left for the tone to which you don't want to apply the effect.

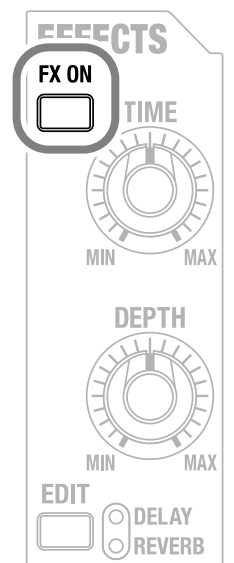

## TIME knob

### If the DELAY indicator is lit

The knob adjusts the spacing between delay sounds (the delay time). Turning the knob toward the right lengthens the spacing.

### If the REVERB indicator is lit

The knob adjusts the length of reverberation (the reverb time). Turning the knob toward the right produces the impression of a more spacious room.

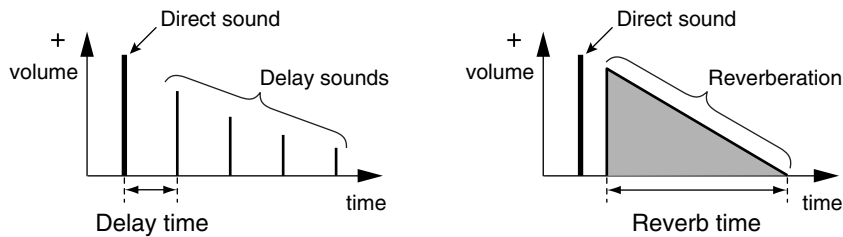

\* The TIME setting is shared by the UPPER tone and LOWER tone (p. 46).

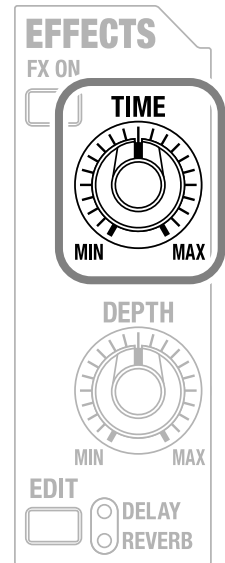

## DEPTH knob

### If the DELAY indicator is lit

The knob adjusts the amount of delayed sound (the delay level). Turning the knob toward the right increases the level.

### If the REVERB indicator is lit

The knob adjusts the amount of reverb sound (the reverb level). Turning the knob toward the right increases the level.

Eight combinations of parameter settings (templates) are provided for both DELAY and for REVERB. The templates also include settings for parameters that cannot be edited using the panel knobs (p. 63).

### Selecting an effect template

1. Use the EDIT button to make the indicator light for the effect (DELAY or REVERB) for which you want to select a template.
2. Hold down the FX ON button, and press one of the NUMBER buttons (1–8).  
The settings of the template whose NUMBER button you pressed are applied to the effect you selected in step 1.

DELAY	Name	REVERB	Name
1	Simple Delay	1	Room 1
2	1 Shot Delay	2	Room 2
3	Medium Delay	3	Studio 1
4	Long Delay	4	Studio 2
5	Analog Delay	5	Hall 1
6	Mod Delay	6	Hall 2
7	Chorus 1	7	Plate 1
8	Chorus 2	8	Plate 2

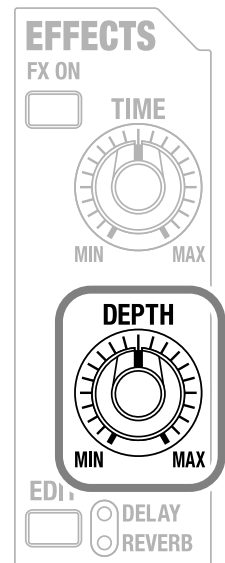

## Combining two sounds (DUAL/SPLIT)

One patch can contain two sounds, each with their own OSC, MIX/MOD, FILTER, AMP and LFO settings. This is just as though the SH-201 contained two synthesizers.

These two sounds are called the **UPPER tone** and the **LOWER tone**.

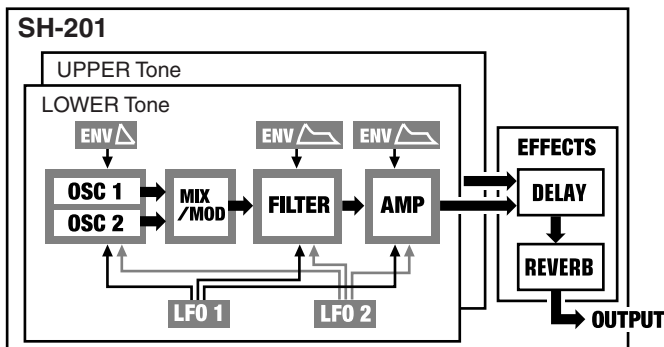

### Playing and editing the UPPER tone

Press the UPPER button so the UPPER button's indicator is lit. (The indicator for the LOWER button goes out.)

When you play the keyboard, the UPPER tone will sound.

Edit the UPPER tone as described in p. 28 through p. 44.

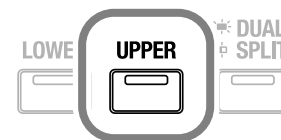

### Playing and editing the LOWER tone

Press the LOWER button so the LOWER button's indicator is lit. (The indicator for the UPPER button goes out.)

When you play the keyboard, the LOWER tone will sound.

Edit the LOWER tone as described in p. 28 through p. 44.



## Layering two sounds to play them simultaneously (DUAL)

The **DUAL** setting will layer the UPPER tone and LOWER tone so that they will be heard simultaneously.

For example you could use this capability to create a patch in which a sound with a short amp envelope attack time (A) is heard first, followed by a slower sound with a longer attack time.

To select Dual, press the DUAL/SPLIT button so its indicator is lit.

When you play the keyboard, the UPPER tone and LOWER tone will sound together.

If you press the UPPER button or LOWER button while Dual is selected, **the indicator of the button you pressed begins blinking**, while the indicator of the other button lights.

When you operate the panel buttons or knobs, **the tone whose indicator is blinking is affected**.

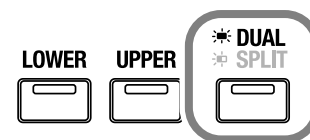

\* If you use the D Beam to control Active Expression (p. 20), only the UPPER tone will be heard when the volume is low, and the LOWER tone will be added as you increase the volume.

\* In the Dual state, two notes are layered; this means that only half the usual number of notes (i.e., five notes) can be played simultaneously.

## Playing different sounds in the right and left hands (SPLIT)

The SPLIT setting will divide the keyboard into two halves so that you can play the UPPER tone in the right side and the LOWER tone in the left side.

For example you could use this capability to play soft-sounding chords in the left hand while you play a sharp solo sound in the right hand, or use the left hand to play a synth bass while you play brass accents in the right hand.

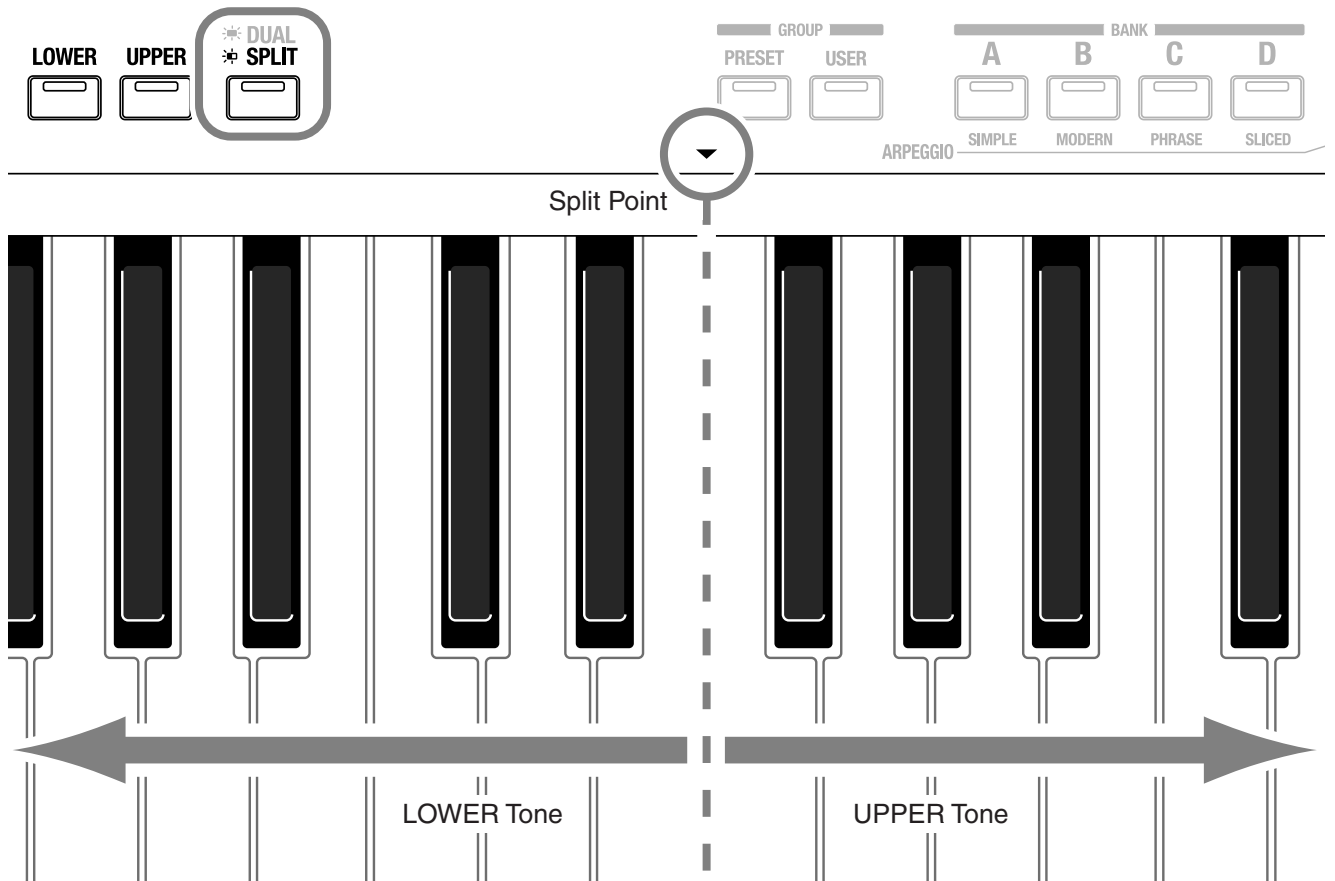

To select Split, press the DUAL/SPLIT button so the indicator is **blinking**.

On the keyboard, keys to the right of the triangle symbol (**split point**) will sound the UPPER tone, and keys to the left of the triangle symbol will sound the LOWER tone.

- \* If you want to change the split point, refer to **Setting the SPLIT POINT** (p. 71).
- \* When you use the OCT UP/DOWN buttons (p. 18) to shift the pitch range of the keyboard (the indicator for the OCT UP button or DOWN button will be lit), the split point will also move up or down in one-octave units in conjunction with the keyboard pitch.

If you press the UPPER button or LOWER button while Split is selected, **the indicator of the button you pressed begins blinking**, while the indicator of the other button lights.

When you operate the panel buttons or knobs, **the tone whose indicator is blinking is affected**.

# Saving a sound you create (WRITE)

A sound you create will change if you move the knobs or select a different patch. It will also be lost if you switch off the SH-201's power.

When you've created a sound you like, you should save it as a user patch.

## Saving a sound

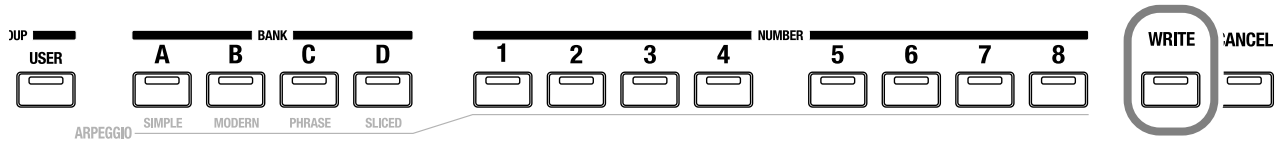

1

**Press the WRITE button.**

The USER button's indicator lights, and the indicators for the previously selected BANK and NUMBER buttons and the WRITE button begin blinking.

2

**Press the BANK and NUMBER buttons to specify where your sound is to be saved.**

The indicators of the BANK button and NUMBER button you pressed begin blinking.

\* Be aware that any patch settings previously existing at the save destination you specify will be overwritten by the newly saved patch.

3

**Press the WRITE button once again.**

The selected BANK and NUMBER buttons and the USER button light, while the indicator for the WRITE button goes out.

You have saved the sound you created.

\* If you decide not to save your sound, press the CANCEL button at any point before pressing the WRITE button in step 3.

No matter how you operate the panel knobs and buttons, the sound of the patches that have been saved will not be affected unless you perform the procedure described here. Please feel free to operate the knobs and buttons and enjoy changing the sound.

You can use the knobs and buttons not only to create sounds, but also as controllers to modify the sound while you play. For example, you can make your performance more expressive by turning the CUTOFF knob or RESONANCE knob to modify the sound while a note continues, or by turning the LFO RATE knob to vary the modulation speed.



# Performing with sound from your digital audio player, etc. (EXT IN)

You can play along on the SH-201 while listening to the audio from a digital audio player, CD player, sampler, or other external source.

You can also apply a filter to the sound from the external audio source.

## Connecting your digital audio player, etc.

**1** On the SH-201's top panel, turn the **INPUT VOL** knob all the way to the left.

**2** On the SH-201's rear panel, connect the **INPUT** jacks to your digital audio player or other audio source.

\* When connection cables with resistors are used, the volume level of equipment connected to the **INPUT** jacks may be low. If this happens, use connection cables that do not contain resistors.

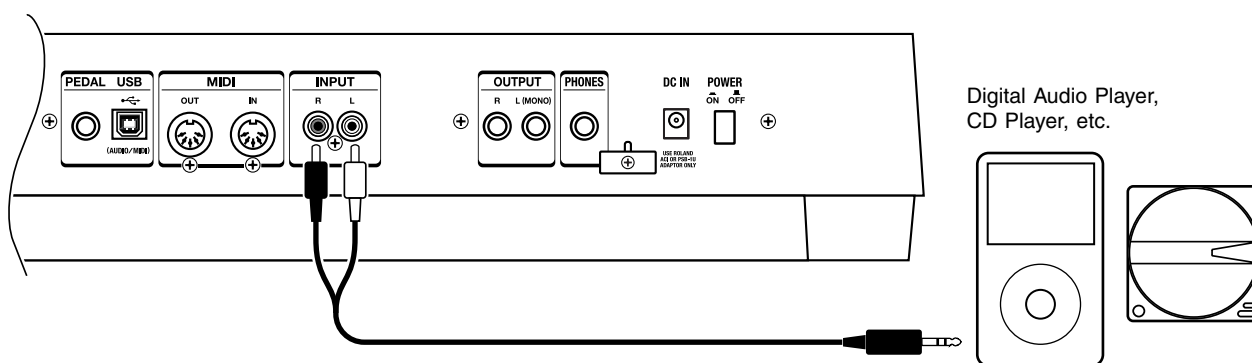

**3** Power-on the device that you connected to the **INPUT** jacks, and raise the volume to an appropriate level.

**4** While playing sound on the audio device connected to the **INPUT** jacks, gradually turn the SH-201's **INPUT VOL** knob toward the right to adjust the volume appropriately.

The sound from the audio device connected to the **INPUT** jacks will be heard from the **OUTPUT** jacks and **PHONES** jack.

## Adjusting the volume from the external source (INPUT VOL knob)

This knob adjusts the volume of the sound from the audio source connected to the **INPUT** jacks. Turn the knob toward the right to increase the volume. If you turn the knob all the way to the left, you will hear no sound from the connected device.

\* The setting of the **INPUT VOL** knob is not stored in the patch.

## Canceling the center sound (CENTER CANCEL ON button)

The **Center Cancel** function removes sounds that are localized at the center of the sound field (such as vocals) from the sound of the device connected to the **INPUT** jacks.

If you press the button so it's lit, sounds localized at the center of the sound field will not be heard.

\* With songs in which low-frequency instruments such as bass or bass drum are localized at the center, these sounds will also be cancelled, causing the sound to seem lighter.

\* The center cancel on/off setting is not stored in the patch.

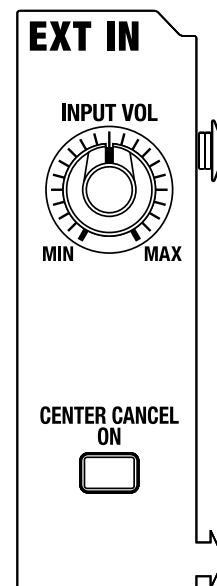

# Modifying the sound from the external source (AUDIO FILTER)

You can apply a filter (**audio filter**) to the sound of the external source connected to the INPUT jacks. You can turn the knobs to change the sound in real time.

\* The audio filter setting is not stored in the patch.

## FILTER ON button

If you press this button so it's lit, the filter will be applied to the sound from the audio source connected to the INPUT jacks.

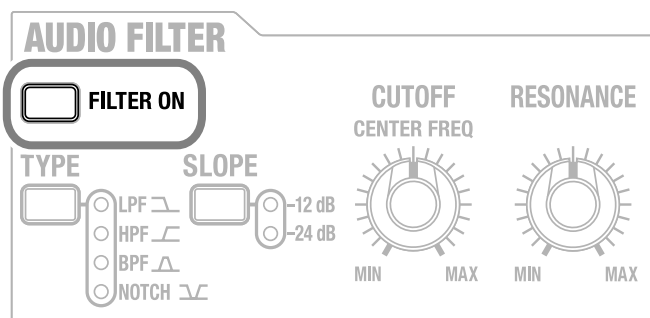

## TYPE button

This button selects the type of filter that will be applied to the sound from the audio source connected to the INPUT jacks.

Press the button so the indicator for the desired filter is lit.

Pressing the button successively cycles you through the settings in this order: LPF -> HPF -> BPF -> NOTCH -> LPF -> ...

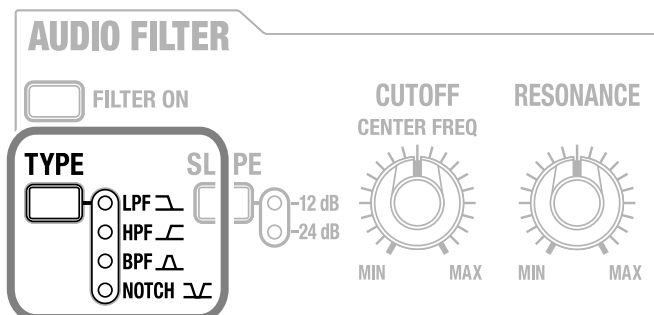

## Filter types

- LPF (Low Pass Filter)**  
 This cuts the frequency region above the cutoff frequency, making the sound more mellow.
- HPF (High Pass Filter)**  
 This cuts the frequency region below the cutoff frequency, emphasizing the high-frequency region.
- BPF (Band Pass Filter)**  
 This passes only the frequencies in the region of the cutoff frequency, and cuts the remaining frequency regions. You can use this to create distinctive sounds.
- NOTCH (Notch Filter)**  
 Only the frequency components in the region of the cutoff frequency will be removed. Use this type of filter to remove a specific sound.

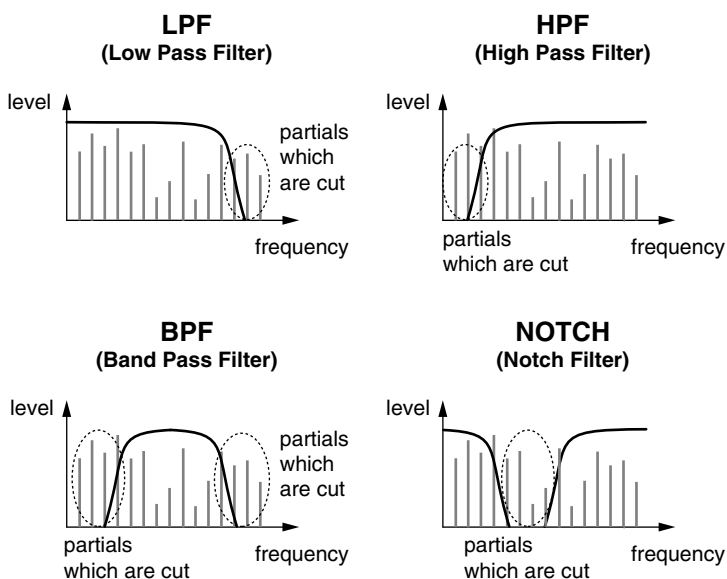

## SLOPE button

This button selects the slope (steepness) of the filter. Press the button so the indicator for the desired slope is lit.

Each time you press the button you can alternate between the -12 dB and -24 dB setting.

- **-12 dB**

The filter slope will be gentle, allowing some of the sound near the cutoff frequency to remain.

- **-24 dB**

The filter slope will be steep, cutting most of the sound immediately above (or below) the cutoff frequency.

### Example: LPF (Low Pass Filter) SLOPE settings

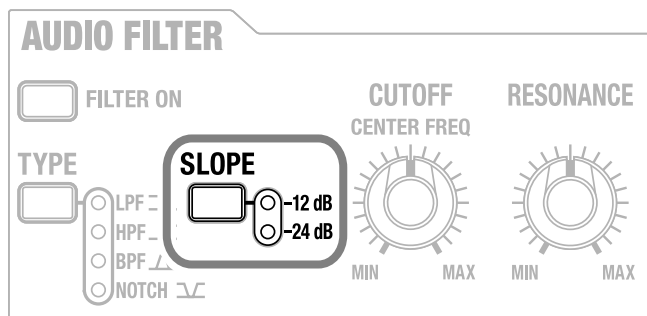
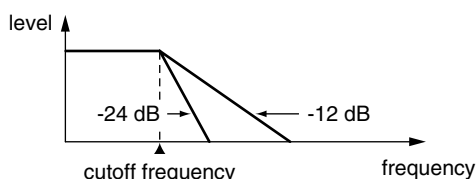

## CUTOFF knob

This specifies the **cutoff frequency** of the filter.

### When the filter TYPE is “LPF”

Turning the knob toward the right brightens the sound, while turning it toward the left darkens (mellows) the sound.

### When the filter TYPE is “HPF”

Turning the knob toward the right will make the sound lighter (less thick), and turning it toward the left will make the sound heavier (thicker).

### When the filter TYPE is “BPF”

Turning the knob toward the right will allow a higher range of frequencies to be heard, and turning it toward the left will allow a lower range of frequencies to be heard.

### If the filter TYPE is “NOTCH”

Turning the knob toward the right will raise the frequency region that is cut, and turning the knob toward the left will lower it.

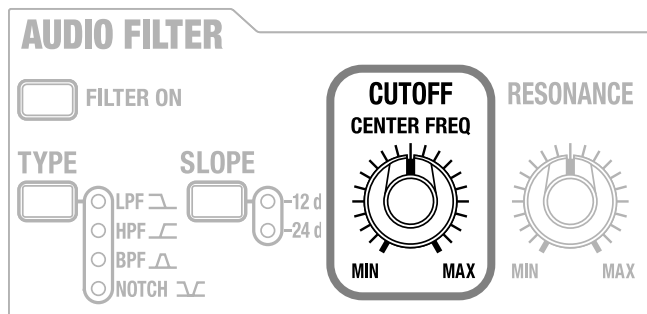

## RESONANCE knob

This boosts the sound in the region near the filter cutoff frequency, adding a distinctive character to the sound.

- Turning the knob toward the right will boost the sound in the region near the cutoff frequency, producing a more strongly distinctive sound.
- Turning the knob toward the left will remove the boost from the sound in the region near the cutoff frequency, producing a less distinctive sound.

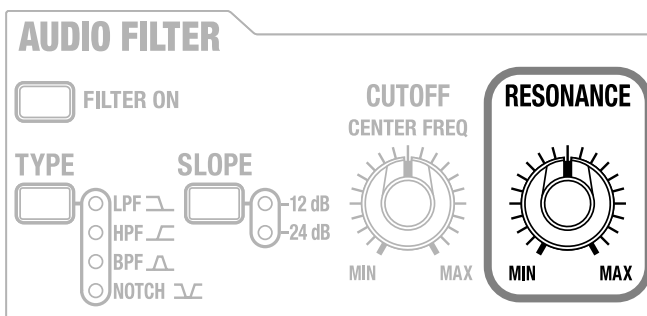

# Using the keyboard to play sound from an external source (WAVE - EXT IN)

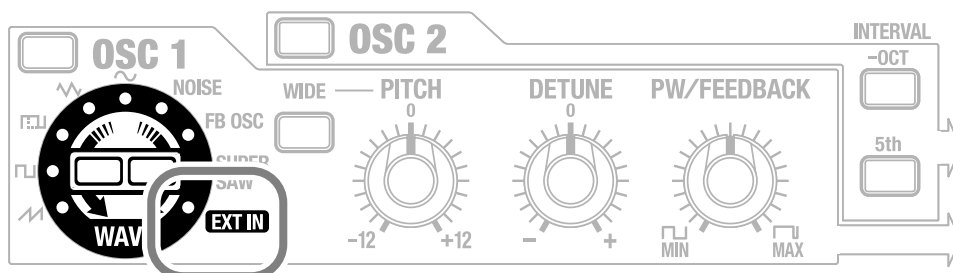

Use the WAVE buttons to select “EXT IN” as the WAVE for OSC 1 or OSC 2 (p. 28).

When you play the keyboard, you will hear the sound from the audio source connected to the INPUT jacks according to the settings of FILTER (p. 34), AMP (p. 38), LFO (p. 40), and EFFECTS (p. 44) in the same way as for an OSC waveform.

You can use the arpeggiator (p. 22) to play this sound rhythmically.

## Signal flow of the sound heard when you play or release the keyboard

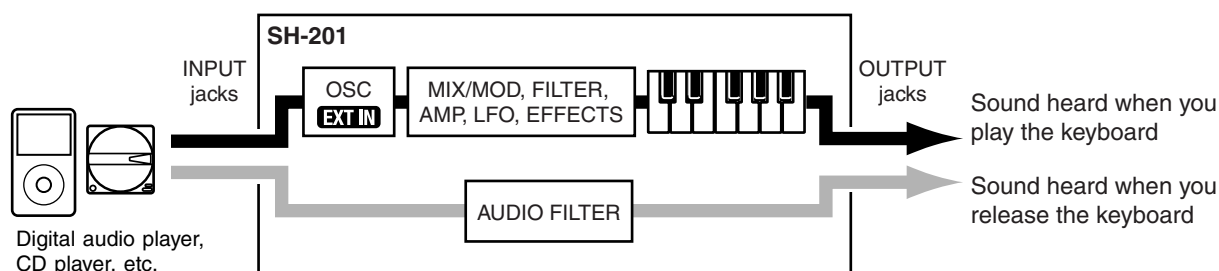

\* The settings of the PITCH knob, DETUNE knob, PW/FEEDBACK knob, and PITCH ENV sliders are ignored for an oscillator whose WAVE is set to “EXT IN.”

## How the sound is produced

- The key you press will not change the pitch of the sound. The sound from the connected audio source device will be heard at its original pitch regardless of the key you press.
- If you press more than one key, the sound from the connected device will be layered according to the number of keys you’re pressing.  
Since the sound may distort if you press a larger number of keys, we recommend that you turn on the Solo function (p. 19).
- When using the OSC EXT IN setting to play the sound of an external audio source, the sound you hear will be mono even if the audio source connected to the INPUT jack is stereo.

### NOTE

For some settings, such as when the AMP LEVEL is lowered or when the FILTER CUTOFF is at the lowest setting, you might not hear any sound when you play the keyboard.

- If the AMP ENV’s R (release time, p. 38) is set to a longer time, the sound that’s passing through the audio filter will not be heard when you take your hand off the keyboard until the release time has elapsed. We recommend that you set the AMP ENV release time to a short value.

## Producing sound from the external device only when you play the keyboard

If you want the sound of the device connected to the INPUT jack to be heard only while you play the keyboard, make the following AUDIO FILTER settings.

- **FILTER ON button:** Lit (audio filter turned on)
- **TYPE button:** LPF indicator lit
- **CUTOFF knob:** Turn fully left

With the above settings, essentially all of the component frequencies of the sound heard when you release the keyboard will be cut by the LPF (Low Pass Filter), meaning that you won't hear any sound.

If you play the keyboard in this state, you will hear sound only while you're playing the keyboard.

# Using the SH-201 together with your computer or another sound module

You can use the SH-201 in more sophisticated ways by connecting it to your computer or to other MIDI equipment.

## Using your computer to record sound or performance data from the SH-201 (USB)

If you've connected the SH-201 to your computer via USB, you'll be able to record the sound of the SH-201 or the sound from a device connected to the SH-201's INPUT jacks into your DAW (Digital Audio Workstation) software on the computer, and to play back the sound from the DAW on a speaker system connected to the OUTPUT jacks of the SH-201. (This is referred to as "USB audio" functionality.)

You can also use your sequence software to record the performance data (MIDI data) from the SH-201. (This is referred to as "USB MIDI" functionality.)

\* You can use USB audio and USB MIDI at the same time.

### Installing the USB driver in your computer

In order to use the SH-201 from your computer as a USB device, you must first install the USB driver. The USB driver is provided on the included "SH-201 Editor CD."

- **Windows users**

Refer to "Readme\_E.txt" on the "SH-201 Editor CD."

- **Macintosh users**

Refer to "ReadMe(English).txt" on the "SH-201 Editor CD."

### Making connections

Use a USB cable (sold separately) to connect the SH-201 to your computer.

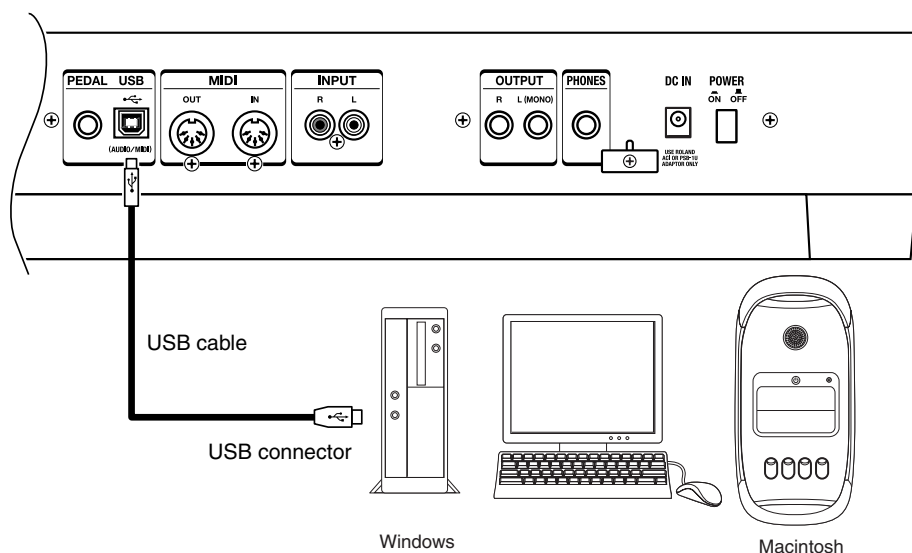

## What is the USB driver?

The USB Driver is a software which passes data between the SH-201 and the application (sequencer software, etc.) that is running on the USB-connected computer.

The USB Driver sends data from the application to the SH-201, and passes data from the SH-201 to the application.

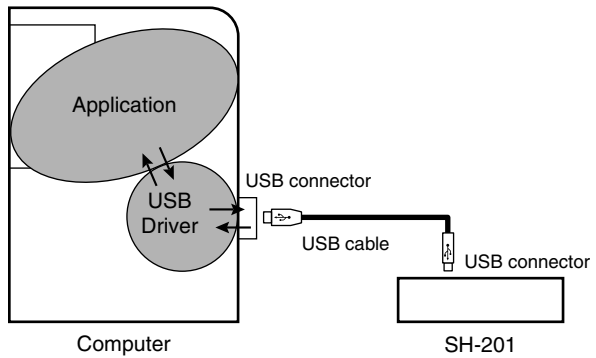

## Note when using USB MIDI

The number of notes that can be played simultaneously (i.e., the polyphony) may decrease when you're using USB MIDI or when connected via MIDI (p. 58). This occurs when the MIDI messages produced when you play the SH-201's keyboard are routed through your computer or external MIDI device and then back to the SH-201, causing the SH-201's sound generator to play a "duplicate" note.

To prevent this problem, you can either turn off the MIDI Thru function of the connected device, or set the KEYBOARD parameter (p. 69) LOCAL SWITCH setting "OFF."

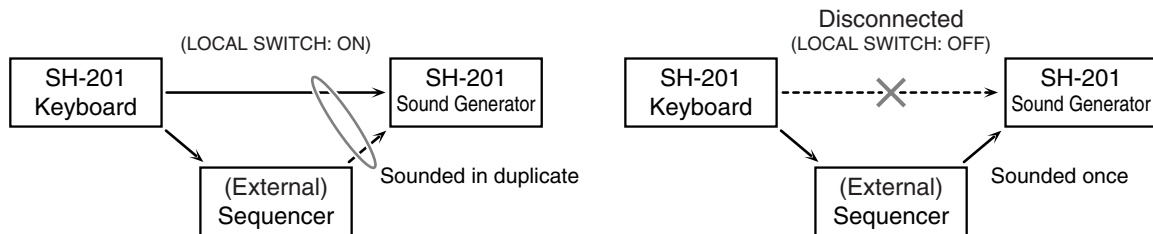

## USB audio signal flow

USB audio signal flow is shown in the illustration below.

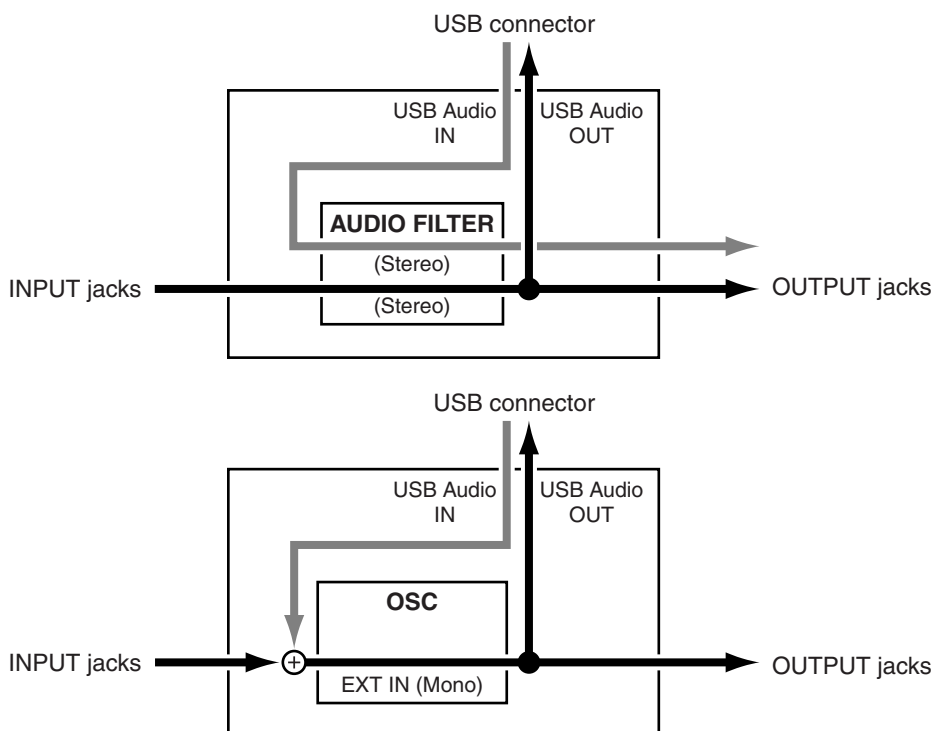

# Creating sounds in greater detail (Editor)/ Using your computer to manage patches (Librarian)

The included SH-201 Editor/Librarian software lets you take even greater advantage of the SH-201.

SH-201 Editor allows you to edit the sound in greater detail; you can edit parameters that cannot be accessed from the SH-201's panel, or create your own original arpeggios.

There are two versions of the SH-201 Editor; a stand-alone version and a plug-in version.

SH-201 Librarian lets you use your computer to manage SH-201 patches efficiently.

\* *If you want to connect the SH-201 to your computer via a USB cable, you must first install the USB driver (p. 54).*

## Installing SH-201 Editor/Librarian on your computer

Detailed instructions are provided in the online manual found on the "SH-201 Editor CD" included with the SH-201.

- **Windows users**

Refer to "Readme\_E.txt" on the "SH-201 Editor CD."

- **Macintosh users**

Refer to "ReadMe(English).txt" on the "SH-201 Editor CD."

## Using SH-201 Editor to create sounds and arpeggios

1. Use a USB cable to connect the SH-201 to your computer.

2. Switch on the power on the SH-201 keyboard.

3. Start up SH-201 Editor.

\* *For details on preparing to start up the SH-201 Editor plug-in version, refer to "QuickStart\_E.htm" in the "QuickStart" (Macintosh: "Quick Start") folder on the "SH-201 Editor CD."*

For details on using SH-201 Editor, start up the software and then click "Help" - "SH-201 Editor Manual."

For details on the parameters, refer to **Creating sounds** (p. 27) and **Parameter list** (p. 60).

\* *If, while using SH-201 Editor, you use the knobs of the SH-201's own panel to edit a parameter listed in the table on p. 72, the parameter values in the editor screen will also change.*

\* *If the **TRANSMIT SWITCH** (p. 69) setting **EDIT DATA** is "ON," the parameter values in the editor screen will also change when you use the SH-201's own panel to edit parameters that are not listed in the table on p. 72.*

## Using SH-201 Librarian to manage patches

1. Use a USB cable to connect the SH-201 to your computer.

2. Switch on the power on the SH-201 keyboard.

3. Start up SH-201 Librarian.

For details on using SH-201 Librarian, start up the software and then click "Help" - "SH-201 Librarian Manual."



## SH-201 Editor System requirements

### System requirements (Windows)

- **Operating System**

**Stand-alone version:**

Microsoft® Windows® 2000 Professional

Microsoft® Windows® XP

**Plug-in version:**

Microsoft® Windows® XP

- **CPU/Clock**

Pentium®/Celeron® processor 800 MHz or higher

- **Memory (RAM)**

384 MB or more

- **Hard Disk**

35 MB or more

- **CD-ROM Drive**

Built-in CD-ROM drive (IDE)

- **Display/Colors**

800 x 600 or higher / 65,536 colors (16 bit High Color) or more

\* Microsoft and Windows are registered trademarks of Microsoft Corporation.

\* Windows® is known officially as: "Microsoft® Windows® operating system."

\* Pentium and Celeron are registered trademarks of Intel Corporation.

### System requirements (Macintosh)

- **Operating System**

**Stand-alone version:**

Mac OS X 10.2 or later

**Plug-in version:**

Mac OS X 10.3.3 or later

- **CPU/Clock**

PowerPC G4 867 MHz or higher

- **Memory (RAM)**

384 MB or more

- **Hard Disk**

35 MB or more

- **CD-ROM Drive**

Built-in CD-ROM drive (IDE)

- **Display/Colors**

800 x 600 or higher / 32,000 colors or more

\* Apple and Macintosh are registered trademarks of Apple Computer, Inc.

\* Mac OS is a trademark of Apple Computer, Inc.

# Using the SH-201 as a controller or a sound module (MIDI)

**MIDI (Musical Instruments Digital Interface)** is a standard specification that allows musical data to be exchanged between electronic musical instruments and computers. With a MIDI cable connecting MIDI devices that are equipped with MIDI connectors, you can play multiple instruments with a single keyboard, have multiple MIDI instruments perform in ensemble, program the settings to change automatically to match the performance as the song progresses, and more.

## About MIDI connectors

The SH-201 is equipped with the two types of MIDI connectors, each which works differently.

### MIDI IN connector

This connector receives MIDI messages that are transmitted from external MIDI devices.

The SH-201 can receive these messages to play notes or select patches, etc.

### MIDI OUT connector

This connector transmits MIDI messages to external MIDI devices.

The SH-201's MIDI OUT connector is used for sending the performance data of the controller section.

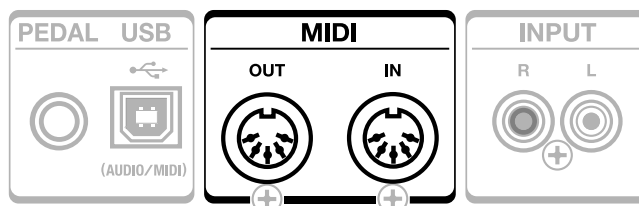

## MIDI channels

MIDI transmits many types of data over a single MIDI cable. This is made possible by the concept of **MIDI channels**. MIDI channels allow messages intended for a given instrument to be distinguished from messages intended for another instrument. In some ways, MIDI channels are similar to television channels. By changing the channel on a television set, you can view the programs that are being broadcast by different stations. In the same way, MIDI also allows a device to select the information intended for that device out of the variety of information that is being transmitted to it.

MIDI uses sixteen channels; 1 through 16. Set the receiving device so that it will receive only the channel that it needs to receive.

### Example:

Set the MIDI keyboard to send Channel 1 and Channel 2, then set sound module A to receive only Channel 1 and sound module B only Channel 2. With this setup, you can get an ensemble performance, with, for example, a guitar sound from sound module A and bass from sound module B.

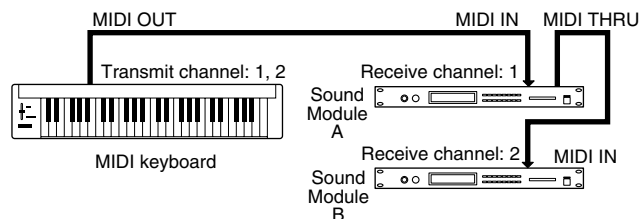
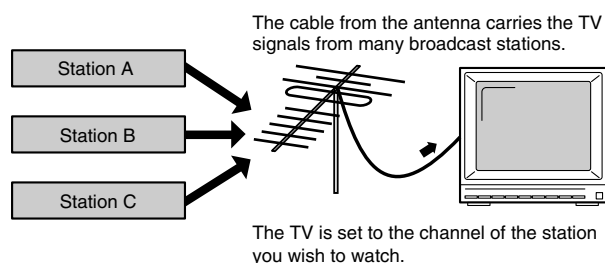

## About the SH-201's MIDI channel

The SH-201's MIDI channel is set to "1."

You can change the MIDI channel setting (**RX/TX CHANNEL** (p. 68)).

## Using an external sequencer to play the SH-201's internal sound generator (MIDI IN)

Here's an example of using the SH-201 as a sound module.

Use a MIDI cable (sold separately) to connect the SH-201's rear panel MIDI IN connector to the MIDI OUT connector of your sequencer or similar device.

When you play back your external sequencer, the SH-201's sound generator section will produce sound in response to the performance data recorded in the sequencer.

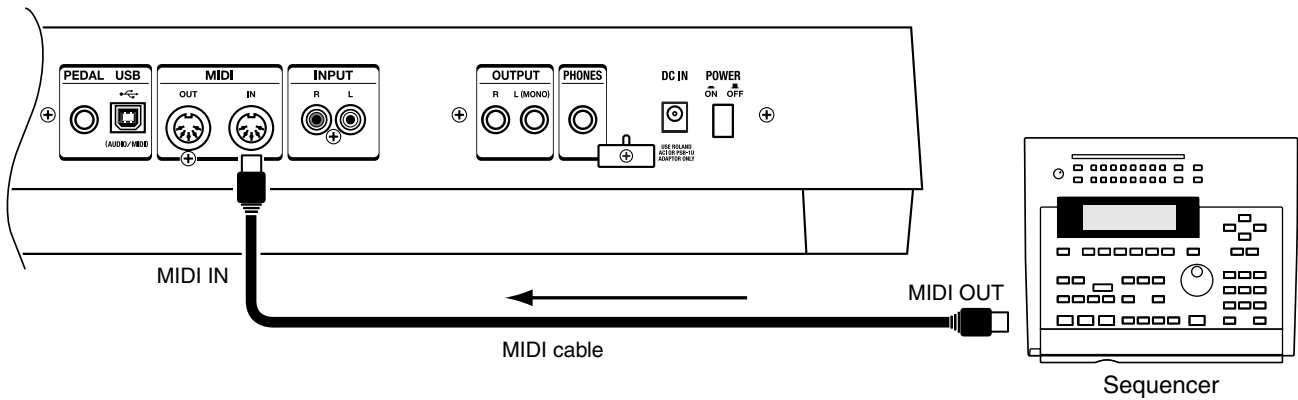

## Using the SH-201's keyboard and knobs to play an external sound module (MIDI OUT)

Here's an example of using the SH-201 as a controller.

Use a MIDI cable (sold separately) to connect the SH-201's rear panel MIDI OUT connector to the MIDI IN connector of your sound module.

When you play the SH-201's keyboard or operate its knobs and buttons, your sound module will produce sound in response to this performance data.

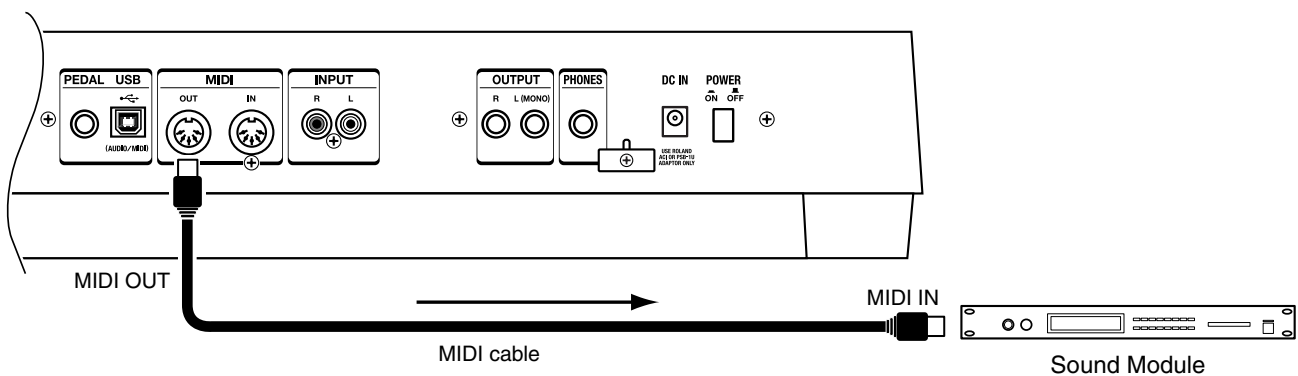

# Parameter list

Here's a list of all the SH-201's parameters.

The right column of the list (the panel operation column) shows how to set parameters that are accessible from the panel of the SH-201 itself.

You can use SH-201 Editor (p. 56) when you want to create sounds in greater detail, or to create your own original arpeggios.

\* The values listed are the ones that appear in the screen of SH-201 Editor.

## OSC MIX/MOD parameters

Parameter	Value	Explanation	Panel operation
<b>OSC1</b>			
WAVEFORM	SAW, SQR, PW-SQR, TRI, SIN, NOISE, FB-OSC, SUPER-SAW, EXT-IN	Selects the waveform that is the basis of the sound.	Press the WAVE buttons (p. 28)
PITCH WIDE	OFF, ON	Expands the range of the PITCH knob by three times.	Press the WIDE button (p. 29)
PITCH	-36– +36	Adjusts the pitch in semitone steps.	Turn the PITCH knob (p. 29)
DETUNE	-50– +50	Adjusts the pitch in one-cent steps.	Turn the DETUNE knob (p. 29)
PW/FEEDBACK	0–127	<ul style="list-style-type: none"> <li>• <b>When WAVEFORM is “PW-SQR”</b> Specifies the width of the upper portion of the square wave.</li> <li>• <b>When WAVEFORM is “FB-OSC”</b> Specifies the amount of output sound that is returned (fed back) to the input.</li> <li>• <b>When WAVEFORM is “SUPER-SAW”</b> specifies the amount of pitch spread between the seven sawtooth waves layered within a single oscillator.</li> </ul>	Turn the PW/FEEDBACK knob (p. 30)
<b>OSC2</b>			
WAVEFORM	SAW, SQR, PW-SQR, TRI, SIN, NOISE, FB-OSC, SUPER-SAW, EXT-IN	Selects the waveform that is the basis of the sound.	Press the WAVE buttons (p. 28)
PITCH WIDE	OFF, ON	Expands the range of the PITCH knob by three times.	Press the WIDE button (p. 29)
PITCH	-36– +36	Adjusts the pitch in semitone steps.	Turn the PITCH knob (p. 29)
DETUNE	-50– +50	Adjusts the pitch in one-cent steps.	Turn the DETUNE knob (p. 29)
PW/FEEDBACK	0–127	<ul style="list-style-type: none"> <li>• <b>When WAVEFORM is “PW-SQR”</b> Specifies the width of the upper portion of the square wave.</li> <li>• <b>When WAVEFORM is “FB-OSC”</b> Specifies the amount of output sound that is returned (fed back) to the input.</li> <li>• <b>When WAVEFORM is “SUPER-SAW”</b> specifies the amount of pitch spread between the seven sawtooth waves layered within a single oscillator.</li> </ul>	Turn the PW/FEEDBACK knob (p. 30)
<b>PITCH ENV</b>			
A	0–127	Specifies the time from when you play a key until the pitch reaches the highest (or lowest) point.	Move the PITCH ENV A slider (p. 31)
D	0–127	Specifies the time from when the pitch reaches its highest (or lowest) point until it returns to the pitch of the key you pressed.	Move the PITCH ENV D slider (p. 31)
OSC1 DEPTH	-63– +63	Specifies the direction and amount of the OSC 1's pitch change.	Press the OSC 1 button and then move the PITCH ENV DEPTH slider (p. 28, p. 31)
OSC2 DEPTH	-63– +63	Specifies the direction and amount of the OSC 2's pitch change.	Press the OSC 2 button and then move the PITCH ENV DEPTH slider (p. 28, p. 31)
<b>MIX/MOD</b>			
MIX/MOD TYPE	MIX, SYNC, RING	Selects how OSC 1 and OSC 2 are to be combined.	Press the MIX/MOD TYPE button (p. 32)
BALANCE	-63– +63	Adjusts the volume balance of OSC 1 and OSC 2.	Turn the BALANCE knob (p. 33)
LOW FREQ	CUT, FLAT, BOOST	Selects whether the low frequency range will be boosted or cut.	Press the LOW FREQ button (p. 33)

## FILTER & AMP parameters

Parameter	Value	Explanation	Panel operation
<b>FILTER</b>			
CUTOFF	0–127	Specifies the cutoff frequency of the filter.	Turn the CUTOFF knob (p. 35)
RESONANCE	0–127	Boosts the sound in the region near the filter cutoff frequency.	Turn the RESONANCE knob (p. 36)
KEY FOLLOW	-200– +200	Causes the filter cutoff frequency to change according to the key you play.	Turn the KEY FOLLOW knob (p. 36)
FILTER TYPE	LPF, HPF, BPF, BYPASS	Selects the type of filter that is applied to the waveform.	Press the FILTER TYPE button (p. 34)
SLOPE	-12 dB, -24 dB	Selects the slope (steepness) of the filter.	Press the SLOPE button (p. 35)
<b>FILTER ENV</b>			
A	0–127	Specifies the time from when you press the key until the cutoff frequency reaches its highest (or lowest) point.	Move the FILTER ENV A slider (p. 37)
D	0–127	Specifies the time from when the cutoff frequency reaches its highest (or lowest) point until it falls to the sustain level.	Move the FILTER ENV D slider (p. 37)
S	0–127	Specifies the cutoff frequency that is to be maintained from when the attack time and decay time have elapsed until you release the key.	Move the FILTER ENV S slider (p. 37)
R	0–127	Specifies the time from when you release the key until the cutoff frequency falls to its minimum level.	Move the FILTER ENV R slider (p. 37)
DEPTH	-63– +63	Specifies the direction and amount in which the cutoff frequency will change.	Move the FILTER ENV DEPTH slider (p. 37)
CUTOFF VELOCITY SENS	-63– +63	Specifies how greatly key velocity will affect the cutoff frequency.	Hold down the CANCEL button and turn the CUTOFF knob (selectable value: 0– +63)
<b>AMP</b>			
LEVEL	0–127	Specifies the volume.	Turn the LEVEL knob (p. 38)
PAN	L64–63R	Adjusts the stereo location of the sound.	Hold down the CANCEL button and turn the KEY FOLLOW knob
OVERDRIVE Switch	OFF, ON	Turns overdrive on/off.	Press the OVERDRIVE button (p. 39)
DRIVE	0–127	Adjusts the depth of the distortion.	Hold down the OVERDRIVE button and turn the LEVEL knob (p. 39)
<b>AMP ENV</b>			
A	0–127	Specifies the time from when you press the key until the maximum volume is reached.	Move the AMP ENV A slider (p. 38)
D	0–127	Specifies the time from when the maximum volume is reached until the volume falls to the sustain level.	Move the AMP ENV D slider (p. 38)
S	0–127	Specifies the volume that is to be maintained after the attack time and decay time have elapsed until you release the key.	Move the AMP ENV S slider (p. 38)
R	0–127	Specifies the time from when you release the key until the volume falls to the minimum level.	Move the AMP ENV R slider (p. 38)
LEVEL VELOCITY SENS	-63– +63	Specifies how greatly key velocity will affect the volume.	Hold down the CANCEL button and turn the LEVEL knob (selectable value: 0– +63)

# LFO parameters

Parameter	Value	Explanation	Panel operation
<b>LFO1</b>			
LFO SHAPE	TRI, SIN, SAW, SQR, TRP, S&H, RANDOM	Selects the LFO 1 waveform.	Press the SHAPE buttons (p. 40)
TEMPO SYNC Switch	OFF, ON	Synchronizes the LFO 1 RATE (modulation speed) to the tempo of the arpeggiator or recorder.	Press the TEMPO SYNC button (p. 41)
TEMPO SYNC NOTE	16, 12, 8, 4, 2, 1, 3/4, 2/3, 1/2, 3/8, 1/3, 1/4, 3/16, 1/6, 1/8, 3/32, 1/12, 1/16, 1/24, 1/32	Specifies the LFO 1 rate (modulation speed) in terms of a note value.	Press the TEMPO SYNC button and then turn the RATE knob (p. 41)
RATE	0–127	Specifies the speed of LFO 1 modulation.	Turn the RATE knob (p. 41)
KEY TRIGGER	OFF, ON	If this is “ON,” LFO 1 will begin a new cycle the moment you press a key.	Hold down the LFO 1 button and press the TEMPO SYNC button
DESTINATION 1	PITCH1, PW1, FILTER, AUDIO-FIL	Specifies the parameter that will be modulated by LFO 1.	Press the DESTINATION 1 button (p. 42)
DEPTH 1	-63– +63	Specifies the depth of modulation that will be applied to the parameter you selected for DESTINATION 1.	Turn the DESTINATION 1 DEPTH knob (p. 42)
DESTINATION 2	PITCH2, PW2, AMP	Specifies the parameter that will be modulated by LFO 1.	Press the DESTINATION 2 button (p. 43)
DEPTH 2	-63– +63	Specifies the depth of modulation that will be applied to the parameter you selected for DESTINATION 2.	Turn the DESTINATION 2 DEPTH knob (p. 43)
FADE TIME	0–127	Specifies the time until the maximum LFO 1 amplitude is reached.	Hold down the LFO 1 button and turn the RATE knob
<b>LFO2</b>			
SHAPE	TRI, SIN, SAW, SQR, TRP, S&H, RANDOM	Selects the LFO 2 waveform.	Press the SHAPE buttons (p. 40)
TEMPO SYNC Switch	OFF, ON	Synchronizes the LFO 2 RATE (modulation speed) to the tempo of the arpeggiator or recorder.	Press the TEMPO SYNC button (p. 41)
TEMPO SYNC NOTE	16, 12, 8, 4, 2, 1, 3/4, 2/3, 1/2, 3/8, 1/3, 1/4, 3/16, 1/6, 1/8, 3/32, 1/12, 1/16, 1/24, 1/32	Specifies the LFO 2 rate (modulation speed) in terms of a note value.	Press the TEMPO SYNC button and then turn the RATE knob (p. 41)
RATE	0–127	Specifies the speed of LFO 2 modulation.	Turn the RATE knob (p. 41)
KEY TRIGGER	OFF, ON	If this is “ON,” LFO 2 will begin a new cycle the moment you press a key.	Hold down the LFO 2 button and press the TEMPO SYNC button
DESTINATION 1	PITCH1, PW1, FILTER, AUDIO-FIL	Specifies the parameter that will be modulated by LFO 2.	Press the DESTINATION 1 button (p. 42)
DEPTH 1	-63– +63	Specifies the depth of modulation that will be applied to the parameter you selected for DESTINATION 1.	Turn the DESTINATION 1 DEPTH knob (p. 42)
DESTINATION 2	PITCH2, PW2, AMP	Specifies the parameter that will be modulated by LFO 2.	Press the DESTINATION 2 button (p. 43)
DEPTH 2	-63– +63	Specifies the depth of modulation that will be applied to the parameter you selected for DESTINATION 2.	Turn the DESTINATION 2 DEPTH knob (p. 43)
FADE TIME	0–127	Specifies the time until the maximum LFO 2 amplitude is reached.	Hold down the LFO 2 button and turn the RATE knob

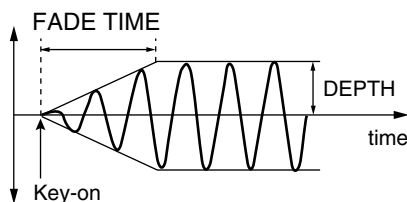

## EFFECTS parameters

Parameter	Value	Explanation	Panel operation
<b>DELAY</b>			
DELAY Switch	OFF, ON	Turns DELAY on/off.	<b>1.</b> Press the EDIT button so the DELAY indicator is lit  <b>2.</b> Press the FX ON button (p. 44)  <b>2.</b> Hold down the FX ON button and turn the DEPTH knob  <b>2.</b> Turn the TIME knob (p. 45)  <b>2.</b> Press the LOWER button and then turn the DEPTH knob (p. 45) <b>2.</b> Press the UPPER button and then turn the DEPTH knob (p. 45)  <b>2.</b> Hold down the FX ON button and turn the TIME knob (selectable value: 0– +98)  <b>2.</b> Hold down the FX ON button and move the AMP ENV R slider <b>2.</b> Hold down the FX ON button and move the AMP ENV S slider
HF DAMP	200, 250, 315, 400, 500, 630, 800, 1000, 1250, 1600, 2000, 2500, 3150, 4000, 5000, 6300, 8000 (Hz), BYPASS	Adjusts the frequency above which the high-frequency content of the delay sound will be reduced.  If you do not want to reduce the high frequencies, set this parameter to BYPASS.	
TIME	0–127	Adjusts the spacing between delay sounds (the delay time).	
DEPTH LOWER	0–127	Adjusts the amount of delayed sound (the delay level).	
DEPTH UPPER	0–127	Adjusts the amount of delayed sound (the delay level).	
FEEDBACK	-98– +98 (%)	Adjusts the amount of the delay sound fed back into the effect.  Negative (-) settings invert the phase.	
MODULATION RATE	0–127	Specifies the speed of modulation that will be applied to the delay sound.	
MODULATION DEPTH	0–127	Specifies the depth of modulation that will be applied to the delay sound.	
<b>REVERB</b>			
REVERB Switch	OFF, ON	Turns REVERB on/off.	<b>2.</b> Press the FX ON button (p. 44)  <b>2.</b> Hold down the FX ON button and turn the TIME knob  <b>2.</b> Hold down the FX ON button and move the FILTER ENV R slider  <b>2.</b> Hold down the FX ON button and turn the DEPTH knob  <b>2.</b> Turn the TIME knob (p. 45)  <b>2.</b> Press the LOWER button and then turn the DEPTH knob (p. 45) <b>2.</b> Press the UPPER button and then turn the DEPTH knob (p. 45) <b>2.</b> Hold down the FX ON button and move the FILTER ENV S slider <b>2.</b> Hold down the FX ON button and move the AMP ENV S slider  <b>2.</b> Hold down the FX ON button and move the AMP ENV R slider <b>2.</b> Hold down the FX ON button and move the FILTER ENV D slider  <b>2.</b> Hold down the FX ON button and move the AMP ENV A slider <b>2.</b> Hold down the FX ON button and move the AMP ENV D slider
PRE DELAY	0.0–100.0 (ms)	Adjusts the delay time from the direct sound until the reverb sound is heard.	
SIZE	1–8	Specifies the size of the simulated room or hall.	
HIGH CUT	160, 200, 250, 320, 400, 500, 640, 800, 1000, 1250, 1600, 2000, 2500, 3200, 4000, 5000, 6400, 8000, 10000, 12500 (Hz), BYPASS	Adjusts the frequency above which the high-frequency content of the reverb sound will be reduced.  If you do not want to reduce the high frequencies, set this parameter to BYPASS.	
TIME	0–127	Adjusts the length of reverberation (the reverb time).	
DEPTH LOWER	0–127	Adjusts the amount of reverb sound (the reverb level).	
DEPTH UPPER	0–127	Adjusts the amount of reverb sound (the reverb level).	
DENSITY	0–127	Adjusts the density of reverb.  The higher the value, the more the density increases with time.	
HF DAMP FREQUENCY	4000, 5000, 6400, 8000, 10000, 12500 (Hz)	Adjusts the frequency above which the high-frequency content of the reverb sound will be reduced or “damped.”	
HF DAMP GAIN	-36–0 (dB)	Adjusts the amount of damping applied to the high-frequency range.	
DIFFUSION	0–127	Adjusts the change in the density of the reverb over time.  The higher the value, the more the density increases with time.	
LF DAMP FREQUENCY	50, 64, 80, 100, 125, 160, 200, 250, 320, 400, 500, 640, 800, 1000, 1250, 1600, 2000, 2500, 3200, 4000 (Hz)	Adjusts the frequency below which the low-frequency content of the reverb sound will be reduced or “damped.”	
LF DAMP GAIN	-36–0 (dB)	Adjusts the amount of damping applied to the low-frequency range.	

## PATCH COMMON parameters

Parameter	Value	Explanation	Panel operation
PATCH NAME	(Up to 12 characters)	You can assign a name to the patch. <b>Available characters/symbols:</b> space, A–Z, a–z, 0–9, ! " # \$ % & ' ( ) * + , - . / : ; < = > ? @ [ \ ] ^ _ ` {   }	–
PATCH LEVEL	0–127	Specifies the volume of the patch.	Hold down the CANCEL button and turn the FX DEPTH knob
TO NE BALANCE	-63 (LOWER)–+63 (UPPER)	Adjusts the volume balance of the UPPER tone and the LOWER tone.	Hold down the CANCEL button and turn the MIX/MOD BALANCE knob
PATCH TEMPO	5–300 (BPM)	This is the tempo value stored for each patch. This will be the tempo of the arpeggio, and the reference tempo used when you specify the LFO cycle in terms of a note length (TEMPO SYNC, p. 62).	Use the TEMPO buttons, or press the TAP button three or more times at quarter-note intervals of the desired timing (p. 22, p. 26)
<b>KEYBOARD</b>			
KEYBOARD MODE	SINGLE, DUAL, SPLIT	<b>SINGLE:</b> Either the UPPER tone or the LOWER tone (not both) will sound. <b>DUAL:</b> The UPPER tone and the LOWER tone will sound together (p. 46). <b>SPLIT:</b> The keyboard will be split into two regions that play the UPPER and LOWER tone separately (p. 47).	Press the DUAL/SPLIT button (p. 46)
KEYBOARD PART	UPPER, LOWER	Specifies which tone will be played from the keyboard when KEYBOARD MODE is "SINGLE."	Press the UPPER/LOWER buttons (p. 46)
SPLIT POINT	A0–C8	Specifies the note (key) at which the keyboard will be split when KEYBOARD MODE is "SPLIT."	<ol style="list-style-type: none"> <li>1. Hold down the CANCEL button and press the TAP button</li> <li>2. Hold down the DUAL/SPLIT button and press a key (p. 71)</li> <li>3. Press the CANCEL button</li> </ol>
<b>POLY/SOLO</b>			
LOWER	SOLO+LEGATO, SOLO, POLY	Turns solo and legato (p. 19) on/off for the LOWER tone. <b>SOLO+LEGATO:</b> Solo and legato will both be on. <b>SOLO:</b> Only solo will be on. <b>POLY:</b> Both solo and legato will be off.	Press the SOLO button (p. 19)
UPPER	SOLO+LEGATO, SOLO, POLY	Turns solo and legato (p. 19) on/off for the UPPER tone.	Press the SOLO button (p. 19)
<b>PITCH BEND RANGE</b>			
LOWER	0–24	Specifies the amount of pitch change that will occur for the LOWER tone when the pitch bend lever (p. 18) is moved all the way to left or right. This is specified in semitone steps. The maximum range is 24 semitones (2 octaves).	<ol style="list-style-type: none"> <li>1. Hold down the CANCEL button and press the TAP button</li> <li>2. Hold down the LOWER button and press a key (C2–C4, p. 71)</li> <li>3. Press the CANCEL button</li> </ol>
UPPER	0–24	Specifies the amount of pitch change that will occur for the UPPER tone when the pitch bend lever (p. 18) is moved all the way to left or right. This is specified in semitone steps. The maximum range is 24 semitones (2 octaves).	<ol style="list-style-type: none"> <li>1. Hold down the CANCEL button and press the TAP button</li> <li>2. Hold down the UPPER button and press a key (C2–C4, p. 71)</li> <li>3. Press the CANCEL button</li> </ol>
<b>OCTAVE SHIFT</b>			
LOWER	-3– +3	Shifts the range of the LOWER tone up or down in steps of one octave.	Hold down the LOWER button and press the OCT UP/DOWN buttons
UPPER	-3– +3	Shifts the range of the UPPER tone up or down in steps of one octave.	Hold down the UPPER button and press the OCT UP/DOWN buttons
<b>PORTAMENTO</b>			
LOWER	OFF, ON	Turns portamento (p. 19) on/off for the LOWER tone.	Press the LOWER button, and then press the PORTAMENTO button (p. 19)
TIME	0–127	Specifies the time over which portamento is to change the pitch of the LOWER tone. Higher values will produce a longer (slower) transition to the pitch of the next note.	Press the LOWER button, then hold down the PORTAMENTO button and press a NUMBER button (1–8) or turn the TIME knob (p. 19)
UPPER	OFF, ON	Turns portamento (p. 19) on/off for the UPPER tone	Press the UPPER button, and then press the PORTAMENTO button (p. 19)
TIME	0–127	Specifies the time over which portamento is to change the pitch of the UPPER tone. Higher values will produce a longer (slower) transition to the pitch of the next note.	Press the UPPER button, then hold down the PORTAMENTO button and press a NUMBER button (1–8) or turn the TIME knob (p. 19)



Parameter	Value	Explanation	Panel operation
<b>CONTROLLER ASSIGN</b>			
MODULATION	OSC1&OSC2, OSC1, OSC2, PW1, PW2, FILTER, AMP, AUDIO-FILTER	Selects the parameter to be modulated by the modulation lever (p. 18).	<ol style="list-style-type: none"> <li>1. Hold down the CANCEL button and press the TAP button</li> <li>2. Press the USER button and then press the BANK A button</li> <li>3. Press a NUMBER button (1–8)  <ol style="list-style-type: none"> <li>1: OSC1&amp;OSC2, 2: OSC1, 3: OSC2,</li> <li>4: PW1, 5: PW2, 6: FILTER, 7: AMP,</li> <li>8: AUDIO-FILTER</li> </ol> </li> <li>4. Press the CANCEL button</li> </ol>
D BEAM	Selects the parameter to be controlled by the D Beam controller if the D BEAM FILTER/ ASSIGN button is pressed.  <b>Value:</b> OSC1-PITCH, OSC1-DETUNE, OSC1-PW, OSC2-PITCH, OSC2-DETUNE, OSC2-PW, MIX/MOD-BALANCE, FILTER-CUTOFF, FILTER-RESONANCE, FILTER-CUTOFF-KEYFOLLOW, AMP-LEVEL, AUDIO-FILTER-CUTOFF, AUDIO-FILTER-RESONANCE, PITCH-ENV-A, PITCH-ENV-D, OSC1-PITCH-ENV-DEPTH, OSC2-PITCH-ENV-DEPTH, LFO1-RATE, LFO1-DEPTH1, LFO1-DEPTH2, LFO2-RATE, LFO2-DEPTH1, LFO2-DEPTH2, FILTER-ENV-A, FILTER-ENV-D, FILTER-ENV-S, FILTER ENV-R, FILTER-ENV-DEPTH, AMP-ENV-A, AMP-ENV-D, AMP-ENV-S, AMP-ENV-R, EFFECTS-DELAY-TIME, EFFECTS-DELAY-DEPTH, EFFECTS-REVERB-TIME, EFFECTS-REVERB-DEPTH, BENDER	Selects the parameter to be controlled by the D Beam controller if the D BEAM FILTER/ ASSIGN button is pressed.	Hold down the D BEAM FILTER/ AS-SIGN button and move the knob or slider of the desired parameter (p. 21).
<b>CONTROLLER DESTINATION</b>			
MODULATION	UPPER, LOWER, BOTH	Selects the tone(s) to be modulated by the modulation lever.  If this is “BOTH,” modulation will be applied to both the UPPER tone and LOWER tone.	<ol style="list-style-type: none"> <li>1. Hold down the CANCEL button and press the TAP button</li> <li>2. Press the USER button and then press the BANK B button</li> <li>3. Press a NUMBER button (1–3)  <ol style="list-style-type: none"> <li>1: UPPER, 2: LOWER, 3: BOTH</li> </ol> </li> <li>4. Press the CANCEL button</li> </ol>
D BEAM	UPPER, LOWER, BOTH	Selects the tone(s) to be controlled by the D Beam controller.  If this is “BOTH,” both the UPPER tone and LOWER tone will be controlled.	Hold down the D BEAM FILTER/ AS-SIGN button and press the UPPER/ LOWER buttons
PITCH BEND	UPPER, LOWER, BOTH	Selects the tone(s) whose pitch will be changed by the pitch bend lever.  If this is “BOTH,” the pitch of both the UPPER tone and LOWER tone will change.	<ol style="list-style-type: none"> <li>1. Hold down the CANCEL button and press the TAP button</li> <li>2. Press the USER button and then press the BANK C button</li> <li>3. Press a NUMBER button (1–3)  <ol style="list-style-type: none"> <li>1: UPPER, 2: LOWER, 3: BOTH</li> </ol> </li> <li>4. Press the CANCEL button</li> </ol>
EXPRESSION	UPPER, LOWER, BOTH	Selects the tone(s) for which the expression pedal will control dynamics.  If this is “BOTH,” the dynamics of both the UPPER tone and LOWER tone will be controlled.	<ol style="list-style-type: none"> <li>1. Hold down the CANCEL button and press the TAP button</li> <li>2. Press the USER button and then press the BANK D button</li> <li>3. Press a NUMBER button (1–3)  <ol style="list-style-type: none"> <li>1: UPPER, 2: LOWER, 3: BOTH</li> </ol> </li> <li>4. Press the CANCEL button</li> </ol>
<b>D BEAM</b>			
D BEAM POLARITY	+, -	Specifies the direction in which the value will change when the D BEAM’s FILTER/ ASSIGN button is lit.  “+” and “-” will invert the direction of change.  * This will not change the direction of the change that occurs when the PITCH button or EXPRESS button is lit.	Hold down the D BEAM FILTER/ AS-SIGN button and choose the direction in which the value will be changed by moving the knob or slider of the desired parameter (p. 21).
ACTIVE EXPRESSION	OFF, ON	Specifies the operation performed by the D Beam controller when you press the D BEAM’s EXPRESS button so it is lit.  <b>OFF:</b> The D Beam controller will change the volume. <b>ON:</b> The D Beam controller will control Active Expression (p. 20) which combines two tones.	Hold down the CANCEL button and press the D BEAM EXPRESS button

# ARPEGGIO parameters

These are arpeggio-related settings. Arpeggio parameters are also saved for each patch.

Parameter	Value	Explanation	Panel operation
ARPEGGIO Switch	OFF, ON	Turns the arpeggiator on/off.	Press the ARPEGGIO button so it is lit (p. 22)
HOLD	OFF, ON	The arpeggio will continue playing even if you take your hand off the keyboard.	Press the ARPEGGIO button so it is blinking (p. 22)
SPLIT ARPEGGIO	UPPER, LOWER, BOTH	Selects the tone(s) to which the arpeggiator is applied when using Split (p. 47). <b>UPPER:</b> Arpeggiator applied only to the UPPER tone. <b>LOWER:</b> Arpeggiator applied only to the LOWER tone. <b>BOTH:</b> Arpeggiator applied to both UPPER and LOWER tones.	–
PATCH TEMPO	5–300 (BPM)	Specifies the tempo of the arpeggiator. This setting is shared with the PATCH COMMON parameter PATCH TEMPO (p. 64).	Use the TEMPO buttons, or press the TAP button three or more times at quarter-note intervals of the desired timing (p. 22)
OCTAVE RANGE	-3– +3	Changes the range of the arpeggio. Adds an effect that shifts arpeggios one cycle at a time in octave units. You can set the shift range upwards or downwards (up to three octaves up or down).	–
ARPEGGIO ACCENT	0–100	Changes the accent strength of the arpeggio. With a setting of “100,” the arpeggiated notes will have the velocities that are programmed by the arpeggio style. With a setting of “0,” all arpeggiated notes will be sounded at a fixed velocity.	–
ARPEGGIO VELOCITY	REAL, 1–127	Specifies the loudness of the notes that you play. <b>REAL:</b> The velocity value of each note will depend on how strongly you play the keyboard. <b>0–127:</b> Each note will have a fixed velocity regardless of how strongly you play the keyboard.	–
GRID	1/4, 1/8, 1/8L, 1/8H, 1/12, 1/16, 1/16L, 1/16H, 1/24	Sets the particular note division and resolution in a “single grid” used in creating the arpeggio in an arpeggio style, and how much of a “shuffle” syncopation is to be applied (none/weak/strong) to it. <b>1/4:</b> Quarter note (one grid section = one beat) <b>1/8:</b> Eighth note (two grid sections = one beat) <b>1/8L:</b> Eighth note shuffle Light (two grid sections = one beat, with a light shuffle) <b>1/8H:</b> Eighth note shuffle Heavy (two grid sections = one beat, with a heavy shuffle) <b>1/12:</b> Eighth note triplet (three grid sections = one beat) <b>1/16:</b> Sixteenth note (four grid sections = one beat) <b>1/16L:</b> Sixteenth note shuffle Light (four grid sections = one beat, with a light shuffle) <b>1/16H:</b> Sixteenth note shuffle Heavy (four grid sections = one beat, with a heavy shuffle) <b>1/24:</b> Sixteenth note triplet (six grid sections = one beat)	–
DURATION	30, 40, 50, 60, 70, 80, 90, 100, 120 (%), FUL	Determines whether the sounds are played staccato (short and clipped), or tenuto (fully drawn out). <b>30–120:</b> For example, when set to “30,” the length of the note in a grid (or when a series of grids is connected with ties, the final grid) is 30% of the full length of the note set in the GRID. <b>FUL:</b> Even if the linked grid is not connected with a tie, the same note continues to sound until the point at which the next new sound is specified.	–
MOTIF	(See below)	Selects the method used to play sounds (motif) when you have a greater number of notes than programmed for the arpeggio style. (See below.) When the number of keys played is less than the number of notes in the arpeggio style, the highest-pitched of the pressed keys is played by default.	–
END STEP	1–32	Specifies the number of steps for the arpeggio style you want to create.	–

## MOTIF

- UP(L):** Only the lowest of the keys pressed is sounded each time, and the notes play in order from the lowest of the pressed keys.
- UP(L&H):** Notes from both the lowest and highest pressed keys are sounded each time, and the notes play in order from the lowest of the pressed keys.
- UP(-):** The notes play in order from the lowest of the pressed keys. No note is played every time.
- DOWN(L):** Only the lowest of the keys pressed is sounded each time, and the notes play in order from the highest of the pressed keys.
- DOWN(L&H):** Notes from both the lowest and highest pressed keys are sounded each time, and the notes play in order from the highest of the pressed keys.
- DOWN(-):** The notes play in order from the highest of the pressed keys. No note is played every time.
- UP&DOWN(L):** Only the lowest of the keys pressed is sounded each time, and the notes play in order from the lowest of the pressed keys and then back again in the reverse order.
- UP&DOWN(L&H):** Notes from both the lowest and highest pressed keys are sounded each time, and the notes play in order from the lowest of the pressed keys and then back again in the reverse order.
- UP&DOWN(-):** The notes play in order from the lowest of the pressed keys and then back again in the reverse order. No note is played every time.
- RANDOM(L):** Only the lowest of the keys pressed is sounded each time, and the notes play randomly.
- RANDOM(-):** The notes play randomly. No note is played every time.
- PHRASE:** Pressing just one key plays a phrase based on the pitch of that key. If you press more than one key, the key you press last is used.

<Examples of motifs>

Action of an arpeggio style starting from the lowest note, "1-2-3-2" when the keys "C-D-E-F-G" are played

- When "UP(L)" is selected as the MOTIF:  
C-D-E-D -> C-E-F-E -> C-F-G-F (-> repeated)
- When "UP(-)" is selected as the MOTIF:  
C-D-E-D -> D-E-F-E -> E-F-G-F (-> repeated)
- When "UP&DOWN(L&H)" is selected as the MOTIF:  
C-D-G-D -> C-E-G-E -> C-F-G-F -> C-E-G-E (-> repeated)

## About arpeggio styles

An Arpeggio Style is a series of data for basic arpeggio patterns and chord styles recorded in the form of a grid consisting of a maximum of 32 steps x 16 pitches.

To make arpeggio settings (including arpeggio styles), you'll need to use SH-201 Editor.

The following illustration shows the Arpeggio window of SH-201 Editor.

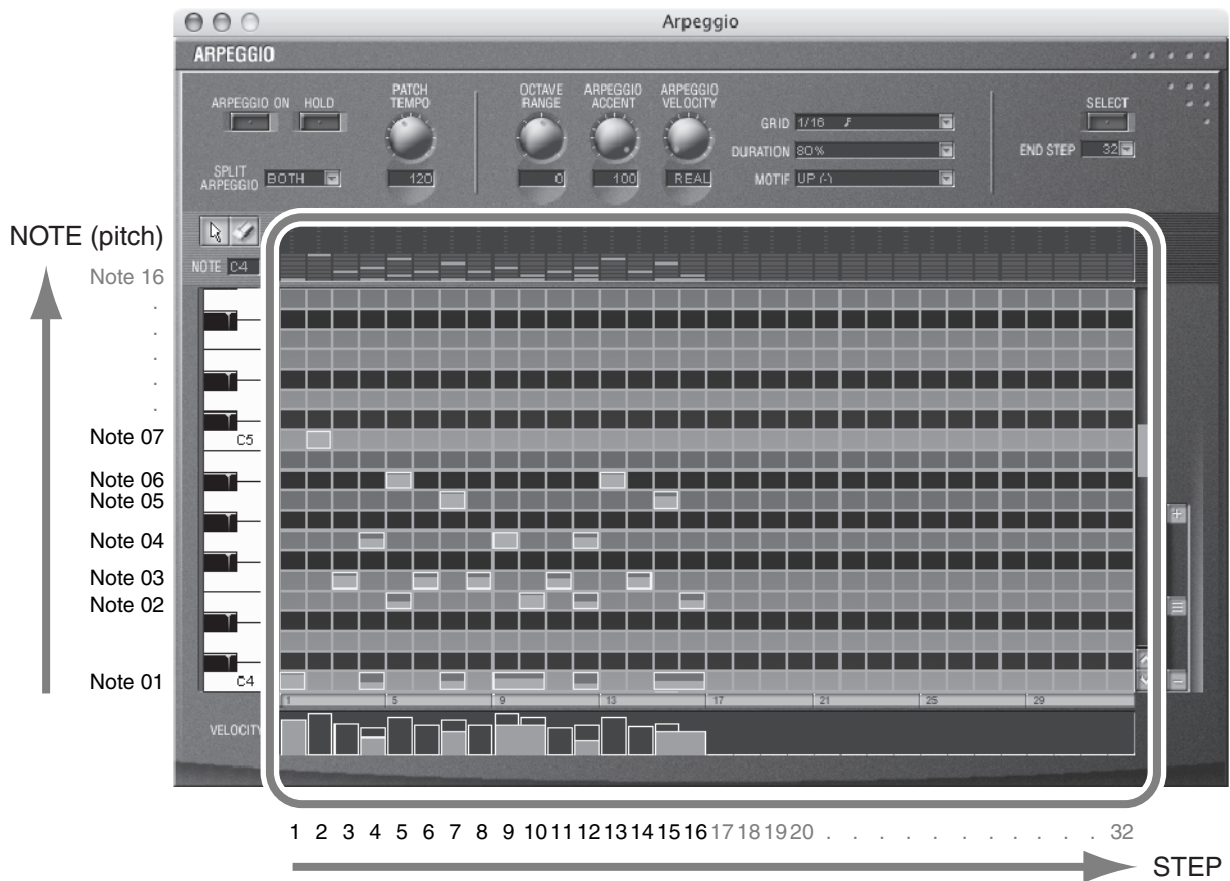

Each grid contains one of the following kinds of data.

- **On (Note On):** Play a note (with velocity data)
- **Tie:** Hold the preceding note
- **Rest:** Don't play a note

This records the position of each key you play relative to "the lowest-pitched key (note) you played," and the order in which you play each key.

\* One arpeggio style can be saved for each patch.

## Parameter list

# SYSTEM COMMON parameters

These are settings that apply to the entire SH-201.

Parameter	Value	Explanation	Panel operation
MASTER LEVEL	0–127	Determines the overall volume of the SH-201.	–
MASTER TUNE	415.30–466.20 (Hz)	Tunes the entire SH-201. Specified in terms of the frequency of the A4 key.	Hold down the CANCEL button and turn the PITCH knob
MASTER KEY SHIFT	-24– +24	Shifts the pitch of the entire SH-201 upward or downward in semitone steps.	–
PATCH REMAIN	OFF, ON	If this is “ON,” the sound of the currently sounding patch will be maintained when you select a different patch.	<ol style="list-style-type: none"> <li>1. Hold down the CANCEL button and press the TAP button</li> <li>2. Press the PRESET button and then press the BANK D button</li> <li>3. Press the NUMBER 1 button</li> </ol> <b>Lit: ON, Dark: OFF</b> <ol style="list-style-type: none"> <li>4. Press the CANCEL button</li> </ol>
CLOCK SOURCE	PATCH, SYSTEM, MIDI, USB	<p>Selects the synchronization source for the arpeggiator/recorder tempo.</p> <p><b>PATCH:</b> Synchronize to the tempo saved in each patch (PATCH TEMPO, p. 64).</p> <p><b>SYSTEM:</b> Synchronize to the tempo that is common to the entire SH-201 system (SYSTEM TEMPO).</p> <p><b>MIDI:</b> Synchronize to MIDI messages received via the MIDI IN connector.</p> <p><b>USB:</b> Synchronize to MIDI messages received via the USB connector.</p>	<ol style="list-style-type: none"> <li>1. Hold down the CANCEL button and press the TAP button</li> <li>2. Press the PRESET button and then press the BANK B button</li> <li>3. Press a NUMBER button (1–4)  <ol style="list-style-type: none"> <li>1: PATCH, 2: SYSTEM, 3: MIDI, 4: USB</li> </ol> </li> <li>4. Press the CANCEL button</li> </ol> <p>* Don't set this to “MIDI” or “USB” unless you need to synchronize the SH-201 to the MIDI clock from an external device. With these settings, the arpeggiator, recorder, tempo-synchronized LFO, etc., will not work correctly.</p>
SYSTEM TEMPO	5–300 (BPM)	This is the common tempo value used by the entire SH-201 when the CLOCK SOURCE parameter (see above) is set to “SYSTEM.”	With the CLOCK SOURCE parameter set to “SYSTEM,” press the TEMPO buttons or press the TAP button three or more times at quarter-note intervals of the desired tempo (p. 22, p. 26).

## MIDI parameters

Parameter	Value	Explanation	Panel operation
RX/TX CHANNEL	1–16	Specifies the MIDI channel on which the SH-201 will transmit and receive MIDI messages.	<ol style="list-style-type: none"> <li>1. Hold down the CANCEL button and press the TAP button</li> <li>2. Press the PRESET button and then press the BANK A button</li> <li>3. Press a NUMBER button (1–8)  <ol style="list-style-type: none"> <li>1–8 (Lit in red): 1–8</li> <li>1–8 (Lit in green): 9–16</li> </ol> </li> <li>4. Press the CANCEL button</li> </ol>
MIDI-USB THRU	OFF, ON	If this is “ON,” MIDI messages received at the MIDI IN connector will be re-transmitted without change from the USB connector.	<ol style="list-style-type: none"> <li>1. Hold down the CANCEL button and press the TAP button</li> <li>2. Press the PRESET button and then press the BANK C button</li> </ol>
SOFT THRU	OFF, ON	If this is “ON,” MIDI messages received at the MIDI IN connector will be re-transmitted without change from the MIDI OUT connector.	<ol style="list-style-type: none"> <li>3. Press a NUMBER button (1, 2)  <ol style="list-style-type: none"> <li>1: MIDI-USB THRU</li> <li>2: SOFT THRU</li> </ol> </li> </ol> <b>Lit: ON, Dark: OFF</b> <ol style="list-style-type: none"> <li>4. Press the CANCEL button</li> </ol>
<b>RECEIVE SWITCH</b>			
PROGRAM CHANGE	OFF, ON	If this is “ON,” the patch number or the patch bank (A–D) will change when a program change message is received.	<ol style="list-style-type: none"> <li>1. Hold down the CANCEL button and press the TAP button</li> <li>2. Press the PRESET button and then press the BANK C button</li> </ol>
BANK SELECT	OFF, ON	If this is “ON,” the patch group (PRESET/USER) will change when a MIDI bank select message is received.	<ol style="list-style-type: none"> <li>3. Press a NUMBER button (3, 4)  <ol style="list-style-type: none"> <li>3: PROGRAM CHANGE</li> <li>4: BANK SELECT</li> </ol> </li> </ol> <b>Lit: ON, Dark: OFF</b> <ol style="list-style-type: none"> <li>4. Press the CANCEL button</li> </ol>

Parameter	Value	Explanation	Panel operation
<b>TRANSMIT SWITCH</b>			
PROGRAM CHANGE	OFF, ON	If this is "ON," a program change message will be transmitted when you press a NUMBER button or BANK button.	<ol style="list-style-type: none"> <li>1. Hold down the CANCEL button and press the TAP button</li> <li>2. Press the PRESET button and then press the BANK C button</li> <li>3. Press a NUMBER button (5–8)</li> <li>5: PROGRAM CHANGE</li> <li>6: BANK SELECT</li> <li>7: EDIT DATA</li> <li>8: ACTIVE SENSING</li> </ol> <b>Lit: ON, Dark: OFF</b> <ol style="list-style-type: none"> <li>4. Press the CANCEL button</li> </ol>
BANK SELECT	OFF, ON	If this is "ON," a MIDI bank select message will be transmitted when you press a GROUP button (PRESET or USER).	
EDIT DATA	OFF, ON	If this is "ON," changes you make to the patch settings will be transmitted as system exclusive messages.	
ACTIVE SENSING	OFF, ON	Turns transmission/reception of active sensing messages on/off.	

## KEYBOARD parameters

Parameter	Value	Explanation	Panel operation
OCTAVE SHIFT	-3– +3	Shifts the keyboard pitch up or down in steps of one octave.	Press the OCT UP/DOWN buttons (p. 18)
TRANPOSE VALUE	-5– +6	Shifts the keyboard pitch up or down in semitone steps.	Hold down the CANCEL button and press the OCT UP/DOWN buttons
LOCAL SWITCH	OFF, ON	Determines whether the sound generator section is disconnected (OFF) from the controller section (keyboard, pitch bend/modulation lever, knobs, buttons, D Beam controller, pedal, and so on); or not disconnected (ON). * Normally this is left "ON," but if you wish to use the SH-201's keyboard and controllers to control only external sound modules, set it to "OFF."	<ol style="list-style-type: none"> <li>1. Hold down the CANCEL button and press the TAP button</li> <li>2. Press the PRESET button and then press the BANK D button</li> <li>3. Press the NUMBER 2 button</li> </ol> <b>Lit: ON, Dark: OFF</b> <ol style="list-style-type: none"> <li>4. Press the CANCEL button</li> </ol>
REMOTE KEYBOARD	OFF, ON	Set this parameter "ON" when you want to use an external MIDI keyboard instead of the SH-201's keyboard. In this case, the MIDI transmit channel of the external MIDI keyboard can be set to any channel. * Normally you will leave this parameter "OFF."	<ol style="list-style-type: none"> <li>1. Hold down the CANCEL button and press the TAP button</li> <li>2. Press the PRESET button and then press the BANK D button</li> <li>3. Press the NUMBER 3 button</li> </ol> <b>Lit: ON, Dark: OFF</b> <ol style="list-style-type: none"> <li>4. Press the CANCEL button</li> </ol>

## PEDAL parameters

Parameter	Value	Explanation	Panel operation
PEDAL POLARITY	STANDARD, REVERSE	Selects the polarity of the pedal. On some pedals, the electrical signal output by the pedal when it is pressed or released is the opposite of other pedals. If your pedal has an effect opposite of what you expect, set this parameter to "REVERSE." * If you are using a Roland pedal (that has no polarity switch), set this parameter to "STANDARD."	Hold down the CANCEL button and press a GROUP button (PRESET or USER) <b>PRESET: STANDARD</b> <b>USER: REVERSE</b>
PEDAL ASSIGN	HOLD, MODULATION, VOLUME, BALANCE, PAN, EXPRESSION, START/STOP, ARP-SW	Selects the function controlled by a pedal connected to the PEDAL jack. <b>HOLD:</b> Sustain the sound while you continue holding down the pedal (p. 21). <b>MODULATION:</b> Apply modulation when you press the pedal. <b>VOLUME:</b> Control the volume. <b>BALANCE:</b> Vary the volume balance between the UPPER tone and LOWER tone. <b>PAN:</b> Move the left/right position (when outputting in stereo). <b>EXPRESSION:</b> Add expression to your performance (p. 21). <b>START/STOP:</b> Press the pedal to start/stop recording or playback on the recorder. <b>ARP-SW:</b> Press the pedal to turn the arpeggiator on/off.	Hold down the CANCEL button and press a NUMBER button (1–8) <b>1: HOLD</b> <b>2: MODULATION</b> <b>3: VOLUME</b> <b>4: BALANCE</b> <b>5: PAN</b> <b>6: EXPRESSION</b> <b>7: START/STOP</b> <b>8: ARP-SW</b>

## Other parameters

You cannot edit these parameters by using SH-201 Editor.

Parameter	Value	Explanation	Panel operation
DEVICE ID	17–24	When you want to transmit or receive System Exclusive messages, set this parameter to match the Device ID number of the other MIDI device.	<ol style="list-style-type: none"> <li>1. Hold down the CANCEL button and press the TAP button</li> <li>2. Press the PRESET button</li> <li>3. Hold down the WIDE button and press a NUMBER button (1–8)  <b>1:</b> 17, <b>2:</b> 18, <b>3:</b> 19, <b>4:</b> 20, <b>5:</b> 21, <b>6:</b> 22, <b>7:</b> 23, <b>8:</b> 24</li> <li>4. Press the CANCEL button</li> </ol>
RECORDER SYNC OUTPUT	OFF, ON	If this is “ON,” MIDI Clock messages will be transmitted to an external MIDI device.	<ol style="list-style-type: none"> <li>1. Hold down the CANCEL button and press the TAP button</li> <li>2. Press the PRESET button</li> <li>3. Press the PLAY/STOP button  <b>PLAY/STOP indicator is lit:</b> ON  <b>PLAY/STOP indicator is dark:</b> OFF</li> <li>4. Press the CANCEL button</li> </ol>
RECORDER METRONOME MODE	OFF, REC-ONLY, REC&PLAY, ALWAYS	Specifies when you want the metronome to sound. <b>OFF:</b> Metronome will not sound. <b>REC-ONLY:</b> Metronome will sound only for recording. <b>REC&amp;PLAY:</b> Metronome will sound for recording and playback. <b>ALWAYS:</b> Metronome will always sound.	<ol style="list-style-type: none"> <li>1. Hold down the CANCEL button and press the TAP button</li> <li>2. Press the PRESET button</li> <li>3. Hold down the REC button and press a BANK button (A–D)  <b>A:</b> OFF  <b>B:</b> REC-ONLY  <b>C:</b> REC&amp;PLAY  <b>D:</b> ALWAYS</li> <li>4. Press the CANCEL button</li> </ol>
RECORDER METRONOME LEVEL	0–7	Specifies the volume of the metronome.	<ol style="list-style-type: none"> <li>1. Hold down the CANCEL button and press the TAP button</li> <li>2. Press the PRESET button</li> <li>3. Hold down the REC button and press a NUMBER button (1–8)  <b>1–8:</b> 0 (minimum)–7 (maximum)</li> <li>4. Press the CANCEL button</li> </ol>

## Setting the SPLIT POINT

**1** Hold down the **CANCEL** button and press the **TAP** button.

**2** Hold down the **DUAL/SPLIT** button and press a key.  
The pressed key will become the split point.

(Example)

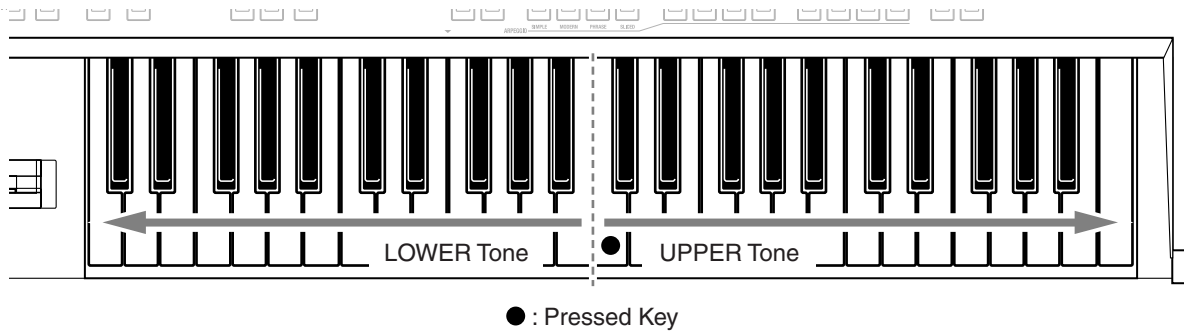

**3** Press the **CANCEL** button.

\* For details on the split point, refer to p. 64

## Setting the PITCH BEND RANGE

**1** Hold down the **CANCEL** button and press the **TAP** button.

**2** Hold down the **UPPER** or **LOWER** button and press a key (C2–C4).

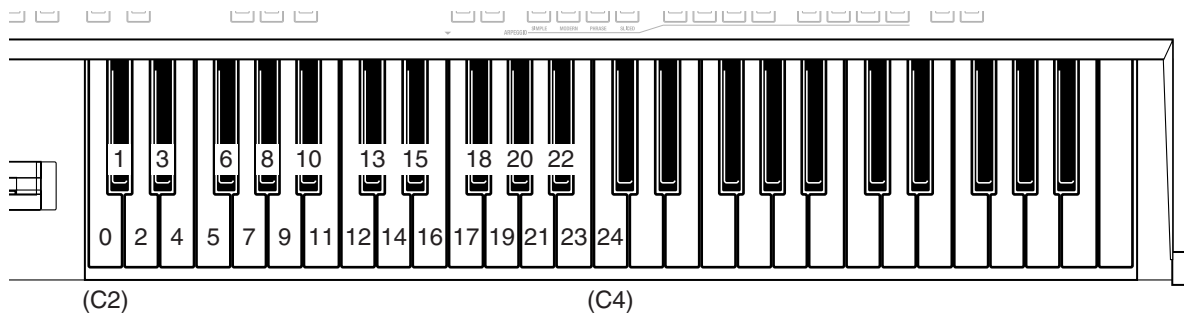

**3** Press the **CANCEL** button.

\* For details on the pitch bend range, refer to p. 64

# Control change message list

This table shows how the data (control change messages) sent from SH-201 Editor or an external MIDI device to control the SH-201 corresponds to the SH-201's parameters.

Parameter		Controller Number
<b>Part</b>	Part Bank Select MSB	CC#00
	Part MODULATION	CC#01
	Part Level	CC#07
	Part Pan	CC#10
	Part Expression	CC#11
	Part Bank Select LSB	CC#32
	Part Hold	CC#64
	Part Sostenuto	CC#66
	Part Pitch (D Beam Pitch Mode)	CC#69
Part Portamento Control	CC#84	
<b>UPPER Tone</b>		
<b>OSC 1</b>	PITCH	CC#20
	DETUNE	CC#76
	PW (Pulse Width)	CC#03
	PITCH ENV DEPTH	CC#24
<b>OSC 2</b>	PITCH	CC#21
	DETUNE	CC#77
	PW (Pulse Width)	CC#95
	PITCH ENV DEPTH	CC#25
<b>PITCH ENV</b>	A (Attack Time)	CC#26
	D (Decay Time)	CC#27
<b>MIX/MOD</b>	BALANCE	CC#08
<b>FILTER</b>	CUTOFF	CC#74
	KEY FOLLOW	CC#30
	RESONANCE	CC#71
<b>FILTER ENV</b>	A (Attack Time)	CC#82
	D (Decay Time)	CC#88
	S (Sustain Level)	CC#28
	R (Release Time)	CC#29
	DEPTH	CC#81
<b>AMP</b>	LEVEL	CC#14
<b>AMP ENV</b>	A (Attack Time)	CC#73
	D (Decay Time)	CC#75
	S (Sustain Level)	CC#31
	R (Release Time)	CC#72
<b>DELAY</b>	DEPTH	CC#93
<b>REVERB</b>	DEPTH	CC#91
<b>LFO 1</b>	RATE	CC#16
	DEPTH 1	CC#18
	DEPTH 2	CC#19
<b>LFO 2</b>	RATE	CC#17
	DEPTH 1	CC#22
	DEPTH 2	CC#23

Parameter		Controller Number
<b>LOWER Tone</b>		
<b>OSC 1</b>	PITCH	CC#78
	DETUNE	CC#79
	PW (Pulse Width)	CC#80
	PITCH ENV DEPTH	CC#70
<b>OSC 2</b>	PITCH	CC#85
	DETUNE	CC#86
	PW (Pulse Width)	CC#87
	PITCH ENV DEPTH	CC#88
<b>PITCH ENV</b>	A (Attack Time)	CC#89
	D (Decay Time)	CC#90
<b>MIX/MOD</b>	BALANCE	CC#09
<b>FILTER</b>	CUTOFF	CC#102
	KEY FOLLOW	CC#103
	RESONANCE	CC#104
<b>FILTER ENV</b>	A (Attack Time)	CC#105
	D (Decay Time)	CC#106
	S (Sustain Level)	CC#107
	R (Release Time)	CC#108
	DEPTH	CC#109
<b>AMP</b>	LEVEL	CC#15
<b>AMP ENV</b>	A (Attack Time)	CC#110
	D (Decay Time)	CC#111
	S (Sustain Level)	CC#112
	R (Release Time)	CC#113
<b>DELAY</b>	DEPTH	CC#94
<b>REVERB</b>	DEPTH	CC#92
<b>LFO 1</b>	RATE	CC#114
	DEPTH 1	CC#115
	DEPTH 2	CC#116
<b>LFO 2</b>	RATE	CC#117
	DEPTH 1	CC#118
	DEPTH 2	CC#119
<b>EFFECTS</b>		
<b>DELAY</b>	TIME	CC#12
<b>REVERB</b>	TIME	CC#13
<b>Others</b>		
<b>AUDIO FILTER</b>	CUTOFF	CC#02
	RESONANCE	CC#04

\* If you use the panel knobs of the SH-201 itself to edit the above parameters while using SH-201 Editor (p. 56), the parameter values in the editor window will also change.

\* If the **TRANSMIT SWITCH** (p. 69) setting **EDIT DATA** is "ON," the parameter values in the editor window will change even if you use the panel knobs of the SH-201 to edit parameters not listed in the above table.



# MIDI implementation chart

SYNTHESIZER

Date : March 1, 2006

Model SH-201

Version : 1.00

Function...	Transmitted	Recognized	Remarks
Basic Channel Default Changed	1-16 1-16	1-16 1-16	
Mode Default Messages Altered	Mode 3 X *****	Mode 3 Mode 3, 4 (M = 1)	* 2
Note Number : True Voice	0-120 *****	0-127 0-127	
Velocity Note On Note Off	O O	O O	
After Touch Key's Channel's	X X	X X	
Pitch Bend	O	O *1	
Control Change	0-4 O *1 7-32 O 64 O 66 X 69-83 O 84 X 85-95 O	O *1 O *1 O *1 O *1 O *1 O *1 O *1	* 3
Program Change : True Number	O *****	O *1 0-31	Program No. 1-32
System Exclusive	O	O *1	
System Common : Song Position : Song Select : Tune Request	X X X	X X X	
System Real Time : Clock : Commands	X X	X *1 X	
Aux Messages : All Sound Off : Reset All Controllers : Local On/Off : All Notes Off : Active Sensing : System Reset	X X X X O X *1	O (120, 126, 127) O X O (123-127) O X	
Notes	* 1 O X is selectable. * 2 Recognized as M=1 even if M≠1. * 3 Refer to "Control change message list" (p. 72) about function of each controller number.		

Mode 1 : OMNI ON, POLY  
Mode 3 : OMNI OFF, POLY

Mode 2 : OMNI ON, MONO  
Mode 4 : OMNI OFF, MONO

O : Yes  
X : No

# Specifications

## SH-201: Synthesizer

### Keyboard

49 keys (velocity sensitive)

### Maximum Polyphony

10 voices

### Sound Generator Organization

Analog Modeling Sound Engine (One MIDI part)  
2 Tones per Patch (Upper and Lower)  
2 Oscillators with MIX/MOD + 1 Filter + 1 Amp + 2 LFOs +  
3 Envelopers

### Patch Memory

Preset: 32  
User: 32

### OSC Section

Oscillator Waveform: SAW, SQUARE, PULSE/PWM,  
TRIANGLE, SINE, NOISE, FB OSC,  
Super SAW, EXT IN  
Knobs: Pitch, Detune, PulseWidth/Feedback  
Envelope: Attack, Decay

### MIX/MOD Section

Oscillator Sync, Ring Modulation, Low Boost/Low Cut  
Knob: Balance (OSC1/OSC2)

### FILTER Section

Filter Type: LPF, BPF, HPF (-12 dB/-24 dB)  
Knobs: Cutoff, Resonance, Key follow  
Envelope: Attack, Decay, Sustain, Release

### AMP section

Knob: Level  
Insertion Effect: Overdrive  
Envelope: Attack, Decay, Sustain, Release

### LFO Section

LFO Shape: TRIANGLE, SINE, SAW, SQUARE, TRAPEZOID,  
SAMPLE AND HOLD, RANDAM  
Knobs: Rate, Destination 1 Depth, Destination 2 Depth  
Tempo Sync ON/OFF

### Effects

Reverb, Modulation Delay

### Controllers

Pitch Bend/Modulation lever  
D Beam Controller

### Arpeggiator

Pattern templates: 32  
Tempo: 5-300  
\* Full programmable with PC editor software

### Recorder

Easy Sequencer  
Number of Track: 1  
Tempo: 5-300

### Jacks/Connectors

OUTPUT Jacks (L/MONO, R) (1/4 inch phone type)  
Headphones Jack (Stereo 1/4 inch phone type)  
INPUT Jacks (L, R) (RCA phono type)  
MIDI Connectors (IN, OUT)  
USB Connector (AUDIO/MIDI)  
PEDAL Jack  
DC IN Jack

### Power Supply

AC Adaptor (DC 9 V)

### Current Draw

600 mA

### Dimensions

884 (W) x 354 (D) x 107 (H) mm  
34-13/16 (W) x 13-15/16 (D) x 4-1/4 (H) inches

### Weight

5.2 kg / 11 lbs 8 oz (excluding AC Adaptor)

### Accessories

Owner's Manual  
AC Adaptor (PSB-1U or ACI series)  
CD-ROM (USB Driver, Editor, Librarian)

### Options

Pedal Switch: DP series  
Foot Switch: BOSS FS-5U  
Expression Pedal: EV-5

\* In the interest of product improvement, the specifications and/or appearance of this unit are subject to change without prior notice.

# Block diagram

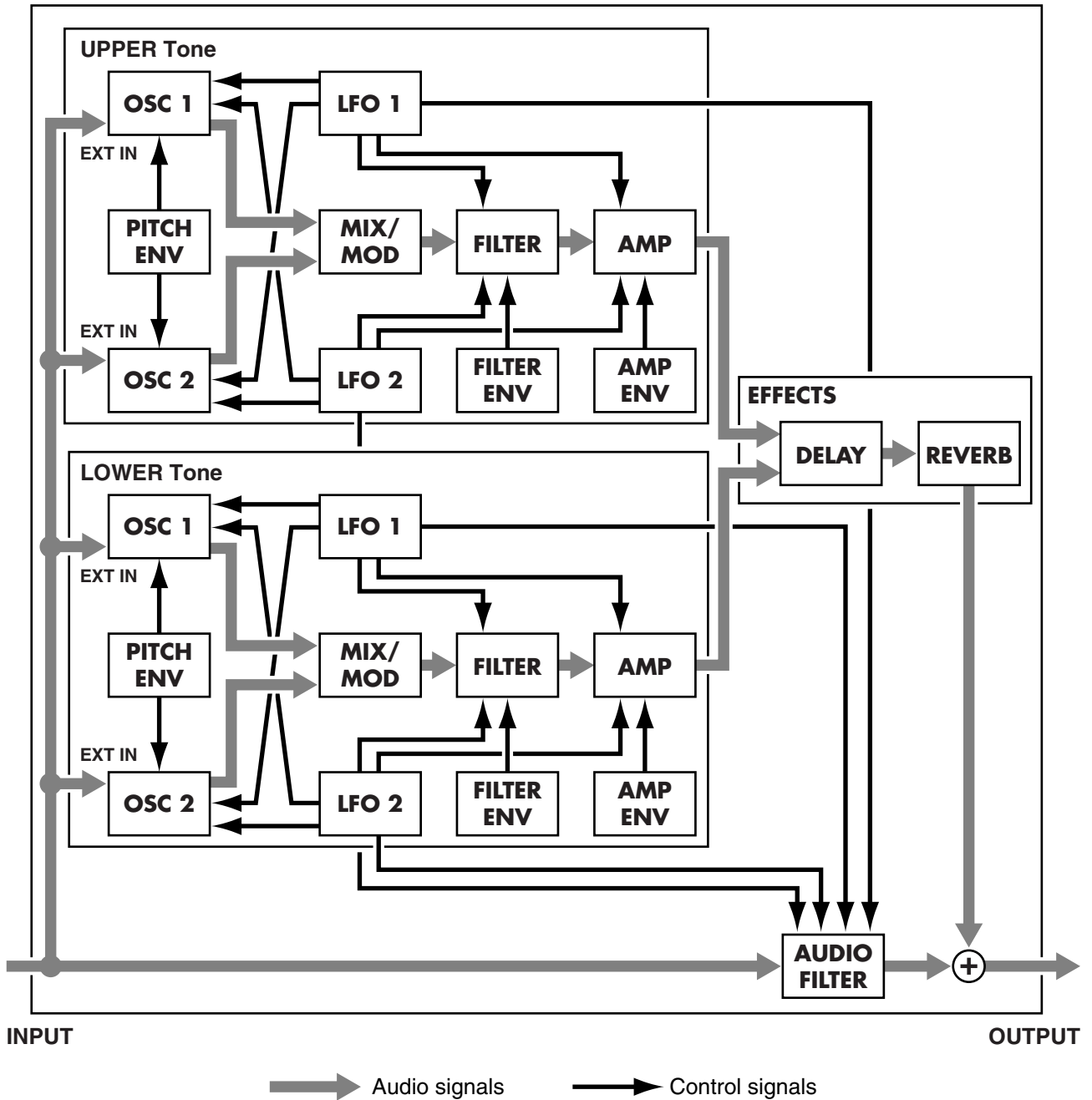

# Panel index

The p. \*\* printed above each knob or button indicates the page that explains that knob or button.

## Top Panel



## Rear Panel



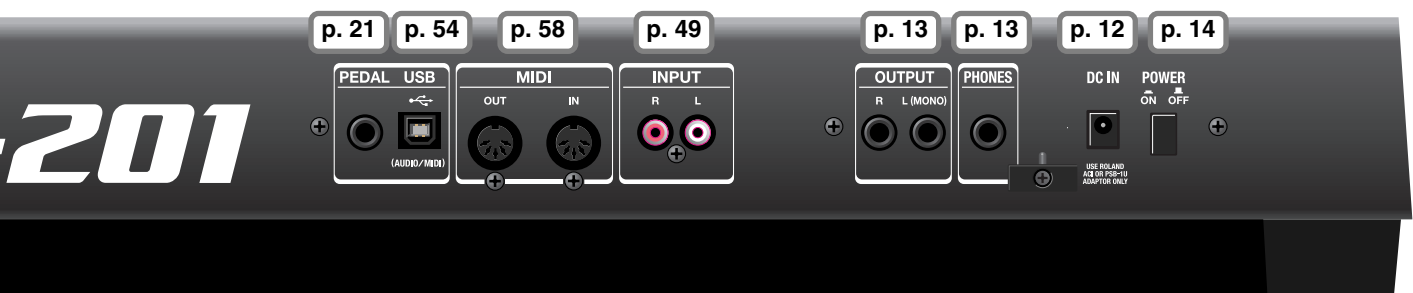
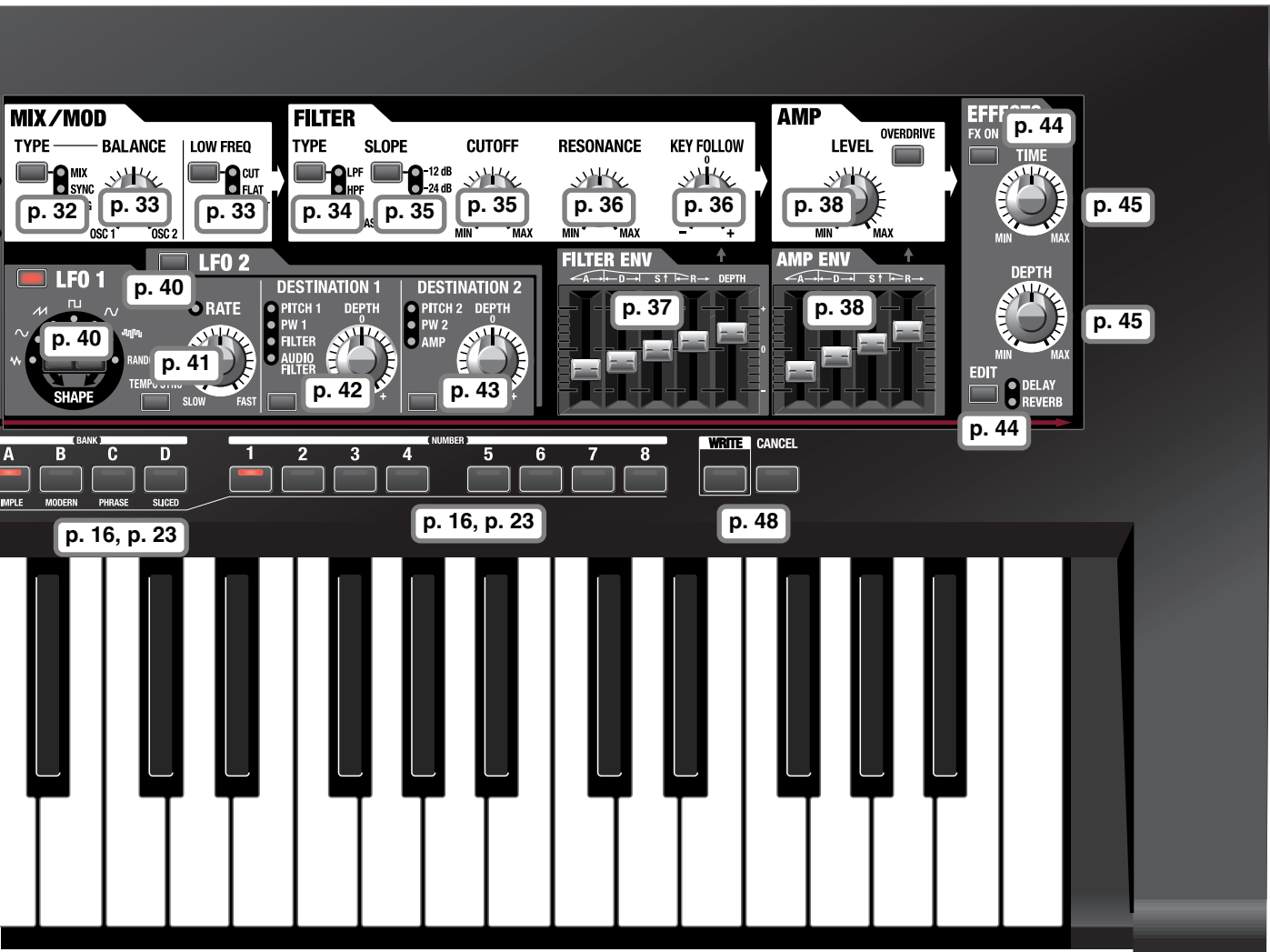

# Index

## Numerics

-12 dB .....	35, 51
-24 dB .....	35, 51
5th .....	30

## A

A (Attack)	
AMP ENV .....	38
FILTER ENV .....	37
PITCH ENV .....	31
AC Adaptor .....	12
Active Expression .....	20, 65
AMP .....	27, 38, 61
DESTINATION 2 .....	43
LEVEL .....	38
OVERDRIVE .....	39
AMP ENV .....	38
Amp Envelope .....	38
ARPEGGIO .....	22, 66
HOLD .....	22
SELECT .....	23
Arpeggio Style .....	67
Arpeggio Template .....	23
ASSIGN .....	21
Attack Time	
Amp Envelope .....	38
Filter Envelope .....	37
Pitch Envelope .....	31
AUDIO FILTER .....	50
CUTOFF .....	51
DESTINATION 1 .....	42
FILTER ON .....	50
RESONANCE .....	51
SLOPE .....	51
TYPE .....	50

## B

BALANCE .....	33
Band Pass Filter .....	34, 50
BANK .....	16–17
BOOST .....	33
BPF .....	34, 50
Button .....	76
BYPASS .....	34

## C

CANCEL .....	25, 48
Cent .....	29
CENTER CANCEL ON .....	49
CLOCK SOURCE .....	68
Combination	
Two Sounds .....	46
Two Waveforms .....	32
Connection	
AC Adaptor .....	12
Computer .....	54
Digital Audio Player .....	49
Headphones .....	13
MIDI .....	59
Pedal .....	21
Speakers .....	13
USB .....	54
CUT .....	33
CUTOFF	
AUDIO FILTER .....	51
FILTER .....	35
Cutoff Frequency .....	35, 51

## D

D (Decay)	
AMP ENV .....	38
FILTER ENV .....	37
PITCH ENV .....	31
D BEAM .....	20, 65
EXPRESS .....	20
FILTER/ASSIGN .....	21
PITCH .....	20
DC IN .....	12
Decay Time	
Amp Envelope .....	38
Filter Envelope .....	37
Pitch Envelope .....	31
DELAY .....	44–45, 63
DEPTH	
DESTINATION 1 .....	42
DESTINATION 2 .....	43
EFFECTS .....	45
FILTER ENV .....	37
LFO .....	42–43
PITCH ENV .....	31
DESTINATION 1 .....	42
DEPTH .....	42
DESTINATION 2 .....	43
DEPTH .....	43

DETUNE .....	29
DEVICE ID .....	70
Distortion .....	39
DOWN .....	18
DUAL .....	46

**E**

EDIT .....	44
Editor .....	56
EFFECTS .....	44, 63
DELAY .....	44-45
DEPTH .....	45
EDIT .....	44
FX ON .....	44
REVERB .....	44-45
TIME .....	45
Envelope .....	27
Amp .....	38
Filter .....	37
Pitch .....	31
Erase	
Phrase .....	25
EXPRESS .....	20
Expression Pedal .....	21, 65
EXT IN .....	49, 52
CENTER CANCEL ON .....	49
INPUT VOL .....	49
OSC .....	28, 52
WAVE .....	28, 52

**F**

Factory Reset .....	17
FB OSC .....	28
Feedback .....	30
Feedback Oscillator .....	28
FILTER .....	27, 34, 61
CUTOFF .....	35
D BEAM .....	21
DESTINATION 1 .....	42
KEY FOLLOW .....	36
RESONANCE .....	36
SLOPE .....	35
TYPE .....	34
FILTER ENV .....	37
Filter Envelope .....	37
FILTER ON .....	50
FILTER/ASSIGN .....	21
FLAT .....	33
FX ON .....	44

**G**

GROUP .....	16
-------------	----

**H**

Headphones .....	13
High Pass Filter .....	34, 50
HOLD	
Arpeggio .....	22
Hold Pedal .....	21
HPF .....	34, 50

**I**

INPUT VOL .....	49
INTERVAL .....	30
5th .....	30
-OCT .....	30

**K**

KEY FOLLOW .....	36
Key Velocity .....	18
Keyboard .....	18, 69
Knob .....	76

**L**

LEGATO .....	19
LEVEL .....	38
LFO .....	40, 62
DEPTH .....	42-43
DESTINATION 1 .....	42
DESTINATION 2 .....	43
PWM (Pulse Width Modulation) .....	42-43
RATE .....	41
SHAPE .....	40
TEMPO SYNC .....	41
Tremolo .....	43
Vibrato .....	42-43
Wah .....	42
Waveform .....	40
LFO 1 .....	40
LFO 2 .....	40
Librarian .....	56
LOCAL SWITCH .....	69
LOW FREQ .....	33
Low Pass Filter .....	34, 50
LOWER .....	46
LPF .....	34, 50

## Index

### M

MASTER TUNE .....	68
MASTER VOL .....	16
Metronome .....	70
MIDI .....	58, 68
MIDI Channel .....	58
MIDI Connector .....	58
MIDI IN .....	58–59
MIDI OUT .....	58–59
MIX .....	32
MIX/MOD .....	32, 60
BALANCE .....	33
LOW FREQ .....	33
TYPE .....	32
Modulation .....	18, 27, 41, 65
Monophonic .....	19

### N

NOISE .....	28
NOTCH .....	50
Notch Filter .....	50
NUMBER .....	16

### O

-OCT .....	30
OCT .....	18
OCT DOWN .....	18
OCT UP .....	18
ON/HOLD .....	22
OSC .....	27–28, 60
5th .....	30
DETUNE .....	29
EXT IN .....	28, 52
INTERVAL .....	30
-OCT .....	30
PITCH .....	29
PW/FEEDBACK .....	30
WAVE .....	28
Waveform .....	28
WIDE .....	29
OSC 1 .....	28
OSC 2 .....	28
Oscillator .....	28
Oscillator Sync .....	32
OUTPUT .....	13
OVERDRIVE .....	39

### P

Panel .....	2, 76
Patch .....	16–17, 64
PATCH REMAIN .....	68
Pedal .....	21, 69
PHONES .....	13
Phrase .....	24
Erase .....	25
Playback .....	26
Recording .....	24
Saving .....	25
PITCH .....	
D BEAM .....	20
OSC .....	29
Pitch .....	18–19
PITCH 1 .....	42
PITCH 2 .....	43
Pitch Bend .....	18, 65
Pitch Bend Range .....	18, 64, 71
PITCH ENV .....	31
Pitch Envelope .....	31
Pitch Range .....	18
PLAY/STOP .....	26
Playback .....	26
PORTAMENTO .....	19, 64
Portamento Time .....	19
Power .....	12, 14
POWER Switch .....	14
PRESET .....	16–17
Preset Group .....	17
Pulse Width .....	30
PW 1 .....	42
PW 2 .....	43
PW/FEEDBACK .....	30
PWM (Pulse Width Modulation) .....	42–43

### R

R (Release)	
AMP ENV .....	38
FILTER ENV .....	37
RANDOM .....	40
RATE .....	41
Rear Panel .....	2, 76
REC .....	24
RECORDER .....	24



- Recording ..... 24
- Rehearsal ..... 25
- Release Time
- Amp Envelope ..... 38
  - Filter Envelope ..... 37
- RESONANCE
- AUDIO FILTER ..... 51
  - FILTER ..... 36
- REVERB ..... 44–45, 63
- RING ..... 32
- Ring Modulator ..... 32
- RX/TX CHANNEL ..... 68
- S**
- S (Sustain)
- AMP ENV ..... 38
  - FILTER ENV ..... 37
- Saving
- Patch ..... 48
  - Phrase ..... 25
- SELECT ..... 23
- Select
- Patch ..... 16
- SHAPE ..... 40
- SLOPE
- AUDIO FILTER ..... 51
  - FILTER ..... 35
- SOLO ..... 19
- SPLIT ..... 47
- Split Point ..... 47, 64, 71
- SUPER SAW ..... 28
- Sustain Level
- Amp Envelope ..... 38
  - Filter Envelope ..... 37
- SYNC ..... 32
- SYNC OUTPUT ..... 70
- Synchronization ..... 68, 70
- Synth Bass ..... 18, 29, 33
- T**
- TAP ..... 22, 24, 26
- TEMPO ..... 22, 24, 26
- Tempo ..... 64, 68
- Arpeggio ..... 22, 66
  - Phrase ..... 24, 26
  - Recorder ..... 24, 26, 68
- TEMPO SYNC ..... 41
- Three Elements of Sound ..... 27
- TIME ..... 45
- Top Panel ..... 2, 76
- Transpose ..... 69
- Tremolo ..... 27, 43
- Tuning ..... 68
- TYPE
- AUDIO FILTER ..... 50
  - FILTER ..... 34
  - MIX/MOD ..... 32
- U**
- UP ..... 18
- UPPER ..... 46
- USB ..... 54
- USB Audio ..... 55
- USB Driver ..... 54–55
- USER ..... 16–17
- User Group ..... 17
- V**
- Velocity ..... 18, 61
- Vibrato ..... 18, 27, 41–43
- Volume ..... 16
- W**
- Wah ..... 42
- WAVE ..... 28
- EXT IN ..... 28, 52
- Waveform
- LFO ..... 40
  - OSC ..... 28
- WIDE ..... 29
- WRITE ..... 48





This product must be disposed of separately  
at your local waste recycling centre.  
Do not dispose of in household waste bin.

For the USA

## DECLARATION OF CONFORMITY Compliance Information Statement

Model Name : SH-201  
Type of Equipment : Synthesizer Keyboard  
Responsible Party : Roland Corporation U.S.  
Address : 5100 S. Eastern Avenue, Los Angeles, CA 90040-2938  
Telephone : (323) 890-3700

For EU Countries



This product complies with the requirements of European Directive 89/336/EEC.

For the USA

## FEDERAL COMMUNICATIONS COMMISSION RADIO FREQUENCY INTERFERENCE STATEMENT

This equipment has been tested and found to comply with the limits for a Class B digital device, pursuant to Part 15 of the FCC Rules. These limits are designed to provide reasonable protection against harmful interference in a residential installation. This equipment generates, uses, and can radiate radio frequency energy and, if not installed and used in accordance with the instructions, may cause harmful interference to radio communications. However, there is no guarantee that interference will not occur in a particular installation. If this equipment does cause harmful interference to radio or television reception, which can be determined by turning the equipment off and on, the user is encouraged to try to correct the interference by one or more of the following measures:

- Reorient or relocate the receiving antenna.
- Increase the separation between the equipment and receiver.
- Connect the equipment into an outlet on a circuit different from that to which the receiver is connected.
- Consult the dealer or an experienced radio/TV technician for help.

This device complies with Part 15 of the FCC Rules. Operation is subject to the following two conditions:

- (1) This device may not cause harmful interference, and
- (2) This device must accept any interference received, including interference that may cause undesired operation.

Unauthorized changes or modification to this system can void the users authority to operate this equipment.  
This equipment requires shielded interface cables in order to meet FCC class B Limit.

For Canada

## NOTICE

This Class B digital apparatus meets all requirements of the Canadian Interference-Causing Equipment Regulations.

## AVIS

Cet appareil numérique de la classe B respecte toutes les exigences du Règlement sur le matériel brouilleur du Canada.

# Patch list

PRESET	Name	Bank Select		Program Change
		MSB	LSB	
A-1	Reso Bass	87	64	1
A-2	Fat Saw Lead			2
A-3	SilkyStrings			3
A-4	RingModBell			4
A-5	OSC SyncLead			5
A-6	SuperSawBrs			6
A-7	Electro Seq			7
A-8	Logic Noize			8
B-1	Fat Bass	87	64	9
B-2	201 Lead			10
B-3	SlowSoft Pad			11
B-4	SuperSawKey			12
B-5	FB OSC Lead			13
B-6	Poly Synth			14
B-7	Sweep Arp			15
B-8	S&H FX 1			16
C-1	Deep Bass	87	64	17
C-2	Soft Lead			18
C-3	BriteStrings			19
C-4	SH-201 EP			20
C-5	Sweep Up			21
C-6	Trancy 201			22
C-7	Sliced Pd/Bs			23
C-8	NoiseWhistle			24
D-1	SH Bass 101	87	64	25
D-2	JP 5th Lead			26
D-3	JP-8 SoftPAD			27
D-4	JP-8 Clav			28
D-5	JP-8SweepPad			29
D-6	JUNO Brass			30
D-7	S&H FX 2			31
D-8	INIT PATCH			32

USER	Name	Bank Select		Program Change
		MSB	LSB	
A-1	TB Dist Lead	87	0	1
A-2	SoftSaw Lead			2
A-3	StackStrings			3
A-4	RingBellStk			4
A-5	SBF FeedBack			5
A-6	Stack Brass			6
A-7	Trance Seq			7
A-8	FormantMover			8
B-1	Brite Bass	87	0	9
B-2	OnlyTimeLead			10
B-3	SquPadSplit			11
B-4	OD Glass Pad			12
B-5	Club Split			13
B-6	modest			14
B-7	PolyChordArp			15
B-8	mod-e-rate			16
C-1	Angry Bass	87	0	17
C-2	Simple SquLd			18
C-3	Alaska Pad			19
C-4	Soft Keys			20
C-5	5th Pad			21
C-6	ProfessorKey			22
C-7	Trance Keys			23
C-8	AsteroidBelt			24
D-1	d&b Bass	87	0	25
D-2	Cheesy Lead			26
D-3	Retro Str			27
D-4	Distant Ring			28
D-5	FB Ring Lead			29
D-6	Stack Saws			30
D-7	Mayhem			31
D-8	Gamelan Bell			32