



Dynacord

Januar 83

DDL 12

**DIGITAL
DELAY**

Service

Specifications DDL 12

1. Mains voltage AC 110 or 220 V +/- 10% 50 - 60 Hz
Input $P_a = 15$ VA +/- 10%

2. Input and output voltages with peak indicator just coming on, duration control anticlockwise to stop, return control anticlockwise to stop, output control clockwise to stop, all tone controls in middle position, measuring frequency 200 Hz, repeat off

a) Inputs +/- 1.5 dB
Input control clockwise to stop, HI/L0 out

	U_E	$U_{E_{max}}$ (input control turned back)
Switchcraft symm.	5.5 mV	190 mV
Jack symm.	5.5 mV	190 mV
Jack asymm.	5.5 mV	190 mV

b) Inputs +/- 1.5 dB
Input control clockwise to stop, HI/L0 in

	U_E	$U_{E_{max}}$ (input control turned back)
Switchcraft symm.	240 mV	3.3 V
Jack symm.	240 mV	3.3 V
Jack asymm.	240 mV	3.3 V

c) Outputs +/- 1.5 dB
Mixed/delay on mixed

	U_A	$U_{A_{max}}$	Load
Switchcraft symm.	2.8 V	11 V	2 K Ohm
Jack asymm.	1.65 V	7 V	2 K Ohm

d) Outputs +/- 1.5 dB
Mixed/delay on delay, return control clockwise to stop

	U_A	Load
Switchcraft symm.	3.4 V	2 K Ohm
Jack asymm.	2 V	2 K Ohm

e) Outputs +/- 1.5 dB
Repeat after recording "on"

	U_A	Load
Switchcraft symm.	3.4 V	2 K Ohm
Jack asymm.	2 V	2 K Ohm

3. Disturbing voltages (evaluated)
measured with Grundig MV 1000
External voltage effective with filter DIN 45405 published 7/67
Noise voltage peak value with filter DIN 45633 published 3/70
Tolerance + 3 dB

a) Input control anticlockwise to stop, HI/L0 in or out, delay/mixed on mixed, return control anticlockwise to stop, output control clockwise to stop, tone control in middle position

	External voltage	Noise voltage
Switchcraft symm.	0.14 mV	0.3 mV
Jack asymm.	0.07 mV	0.15 mV

b) Input control clockwise to stop, HI/L0 out, input symm. terminated with 600 ohms

	External voltage	Noise voltage
Switchcraft symm.	1.70 mV	2.2 mV
Jack asymm.	0.85 mV	1.1 mV

c) Input control clockwise to stop, HI/L0 in, input symm. terminated with 600 ohms

	External voltage	Noise voltage
Switchcraft symm.	0.17 mV	0.3 mV
Jack asymm.	0.08 mV	0.15 mV

d) Input control anticlockwise to stop, HI/L0 in or out, delay/mixed on delay, return control clockwise to stop, output control clockwise to stop, tone control in middle position

	External voltage	Noise voltage
Switchcraft symm.	0.48 mV	0.7 mV
Jack asymm.	0.24 mV	0.35 mV

e) Input control clockwise to stop, HI/L0 out, input terminated with 600 ohms

	External voltage	Noise voltage
Switchcraft symm.	1.46 mV	2.5 mV
Jack asymm.	0.79 mV	1.25 mV

f) Input control clockwise to stop, HI/L0 in, input terminated with 600 ohms

	External voltage	Noise voltage
Switchcraft symm.	0.54 mV	0.7 mV
Jack asymm.	0.27 mV	0.35 mV

4. Harmonic distortion factor, measured with "Sound Technology 1700A" measuring bridge

a) Modulation 3 dB below full modulation

	Original	Delay (variable with R 290 and R 293)
at 40 Hz	0.05%	0.2%
at 400 Hz	0.02%	0.1%
at 6300 Hz	0.02%	0.1%
at 12500 Hz	0.02%	

b) Modulation 15 dB below full modulation

at 40 Hz	0.1%
at 400 Hz	0.1%
at 6300 Hz	0.2%

5. Crosstalk

a) Input fed with 2.8 mV, mixed/delay on delay, return control open, effect "off", measuring frequency 7000 Hz

U_A 1 mV

b) Return control closed, effect "on"

U_A 1 mV

6. Start delay

Delayed signal must only be given 1 second after switching on, similarly the signal must be blocked 1 second after operating short/long switch

7. a) Setting "long"

Variable from 7 to 500 ms in stages with delay switch, coarse/fine setting, with MEM additional card from 14 to 1000 ms, LED "x2" must come on at same time

b) Setting "short"

Variable from 0.5 to 32 ms in stages with delay switch, coarse/fine setting, LED "x2" off in all cases

8. Cycle frequency (speed, depth anticlockwise to stop)

measured on terminal strip pin 47:516.1 kHz +/- 5 kHz

Modulation: saw-tooth, inverse saw-tooth, triangle

Frequency (speed control) 0.1 Hz (anticlockwise to stop) to 10 Hz

Deviation (depth control) 2:1

9. Frequency response

For original, delay, effect of tone control, see sheet 4

307 757
DDL 12

1. Original
2. Effekt Bass / Treble lin.
3. Effekt Bass / Treble auf
4. Effekt Bass / Treble zu

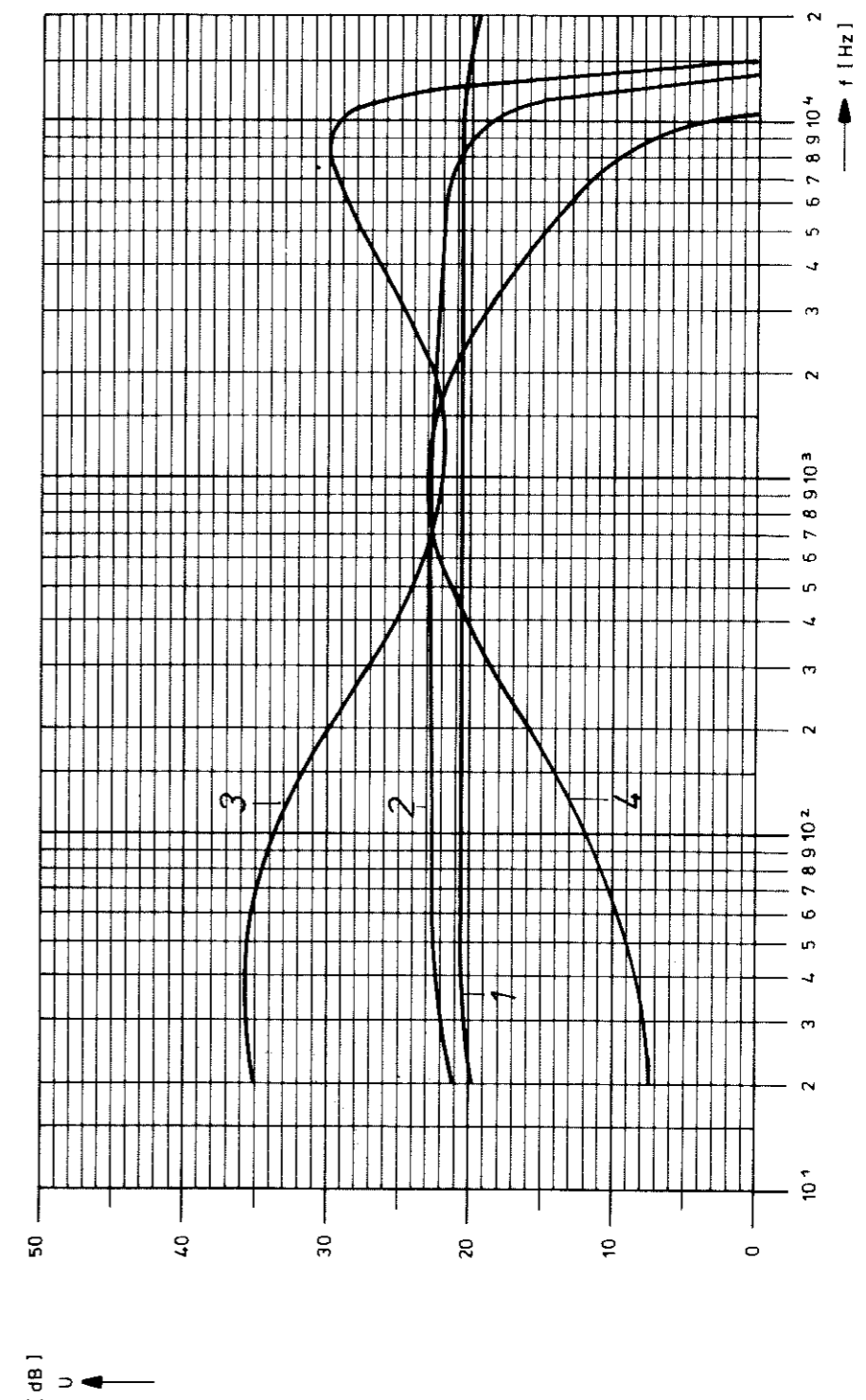

DDL 12 DIGITAL DELAY LINE

Blockdiagram

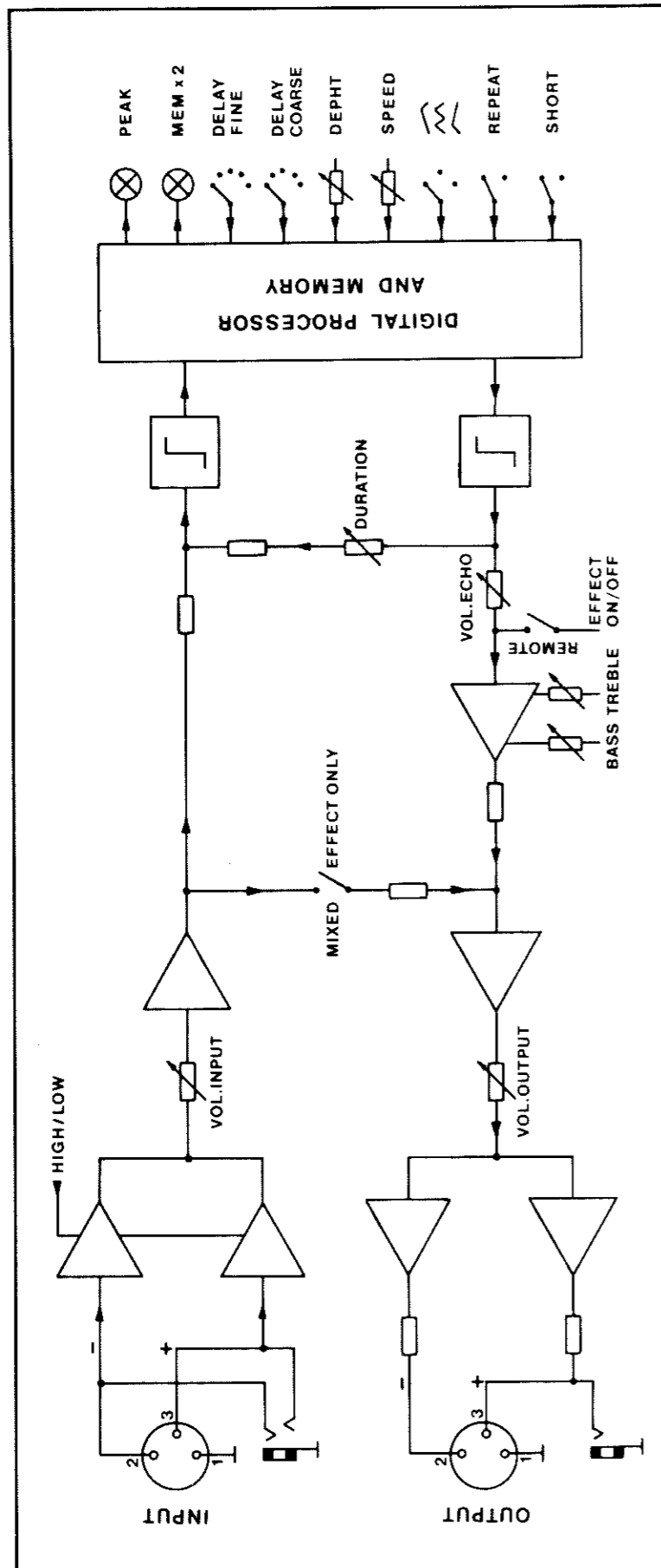

Technical-Data

Input level:
unbalanced
electr. balanced

6 mV - 3,1 V / 50 K Ohm
6 mV - 3,1 V / 100 K Ohm

Output level (Delay):
unbalanced
electr. balanced

2,8 V / 0,5 K Ohm
5,4 V / 1 K Ohm

Frequency response:
Original
Delay

20 ... 20 000 Hz
20 ... 12 000 Hz

Delay Time:
without MEM 13
with MEM 13
"SHORT"

7 - 500 ms
14 - 1.000 ms
0,2 - 16 ms

S/N ratio Delay
S/N ratio Original

IV 82 dB
IV 90 dB

VCO
frequency
depth

10 Hz - 0,1 Hz
2 : 1

Dimensions (W x H x D)
Weight
Line voltage

483 (19") x 44 (1 HE/HU) x 255 mm
3,8 kg (8 lbs)
220/110 V ~ AC 50 - 60 Hz

Optional accessories:
Footswitch
Additional memory

FS 11
MEM 13

With additional memory MEM 13 no change -
of specifications

Subject to change!

Delay Time 1000 ms

Fitting assembly MEM 13

Insert circuit board into the multipoint connector. Pay attention to the numeration 1 - 44. Secure circuit board with the screw (arrow). When operating the unit the LED-indicator (10) is lighting up, and the selected delay time is doubled.

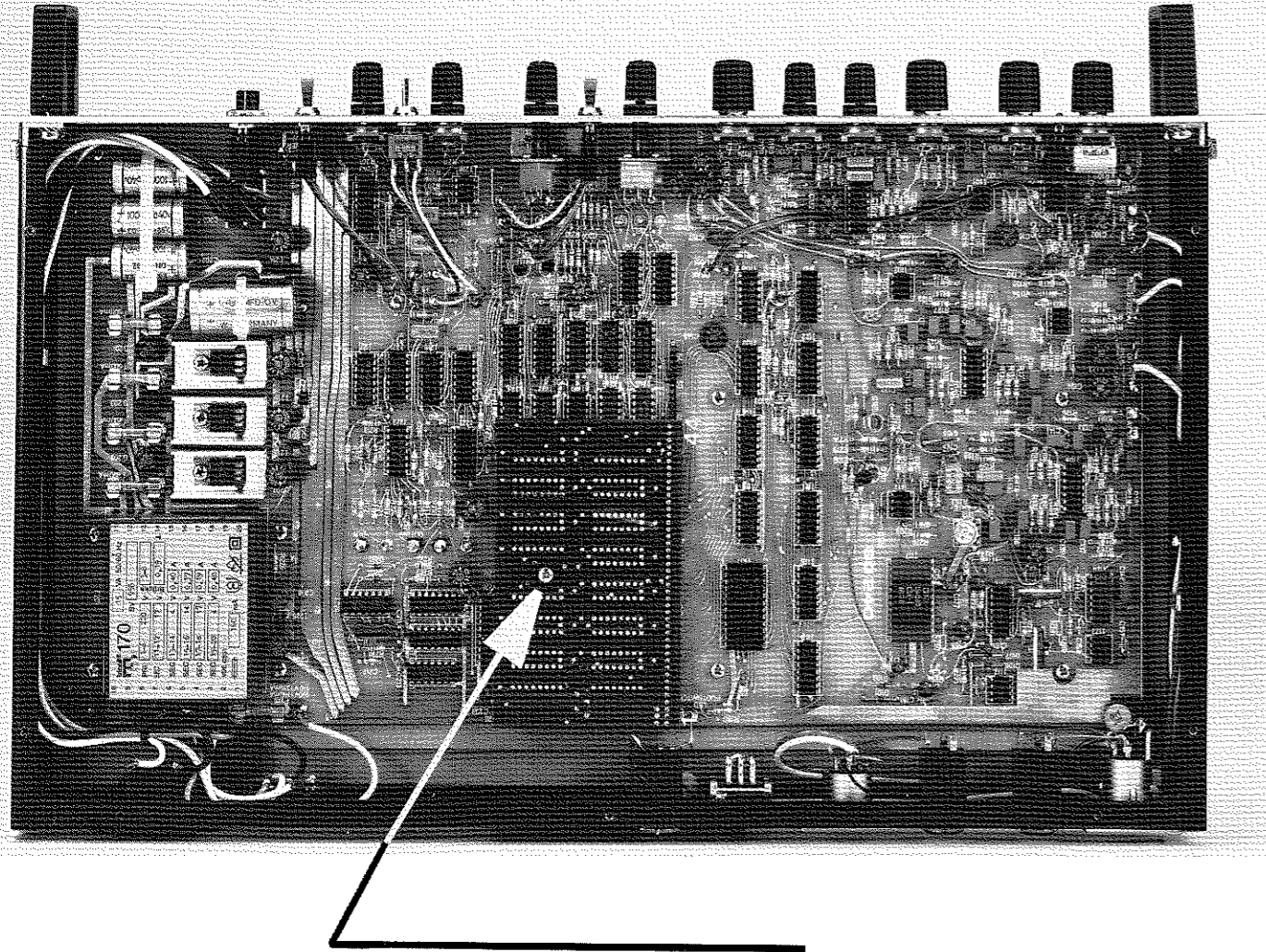

SCREW

Circuit Diagram DDL 12

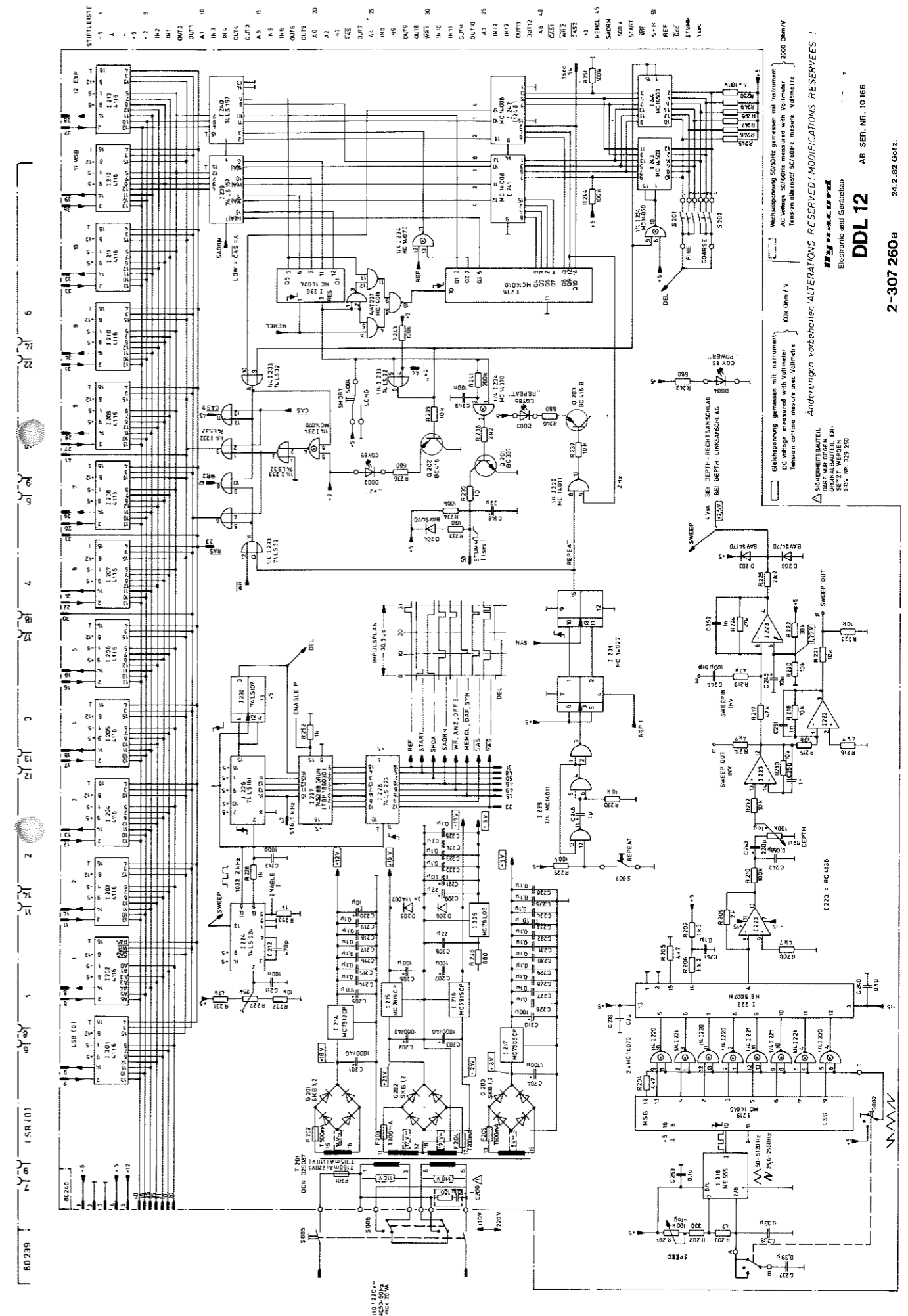

Circuit Diagram

307 277
MEM 13

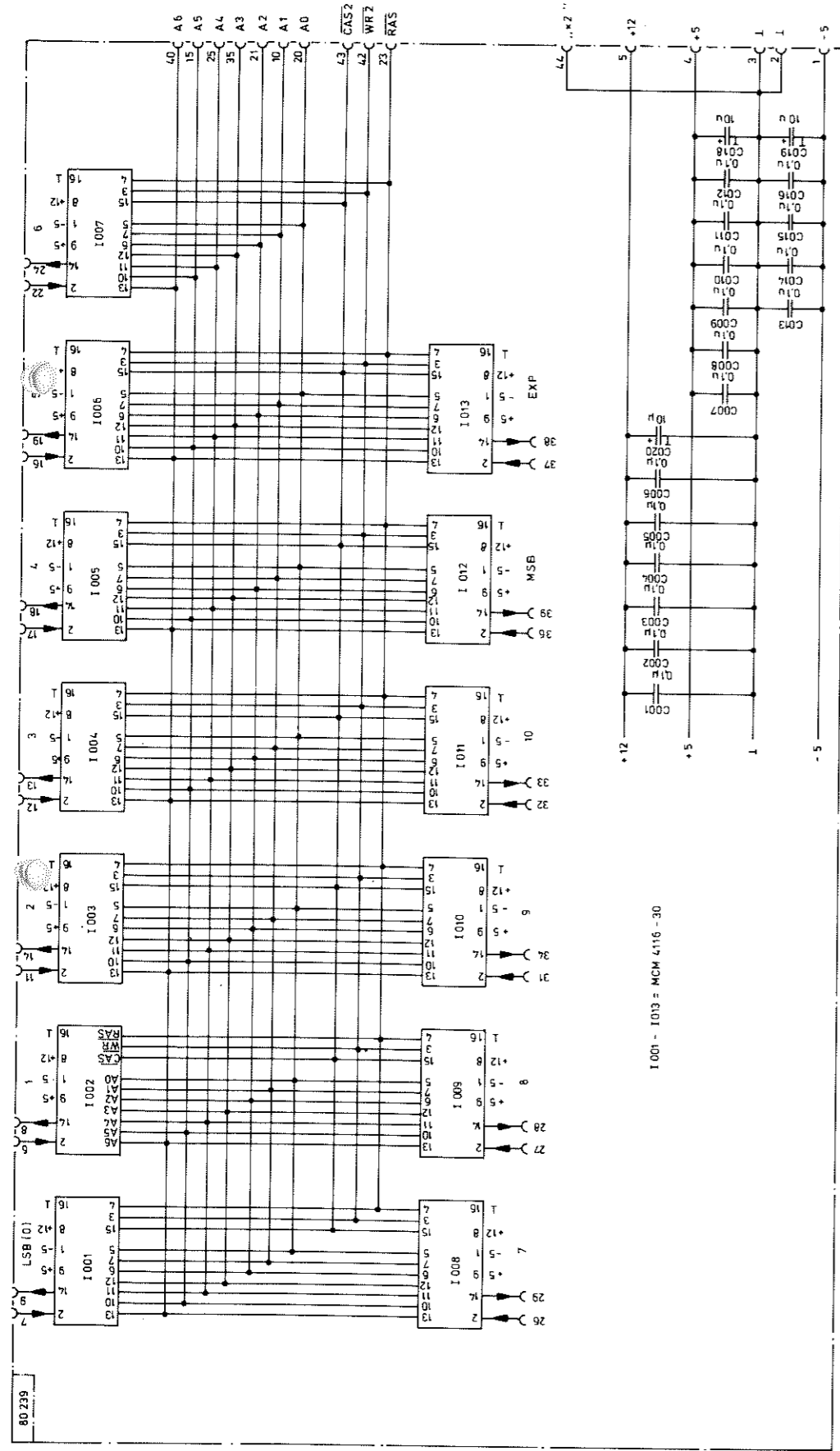

1001 - 1013 = MCM 4116 - 30

ANSICHT VON
B - SEITE

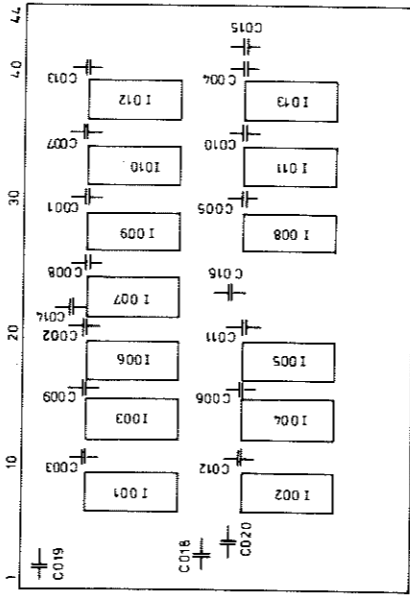

Circuit Diagram DDL 12

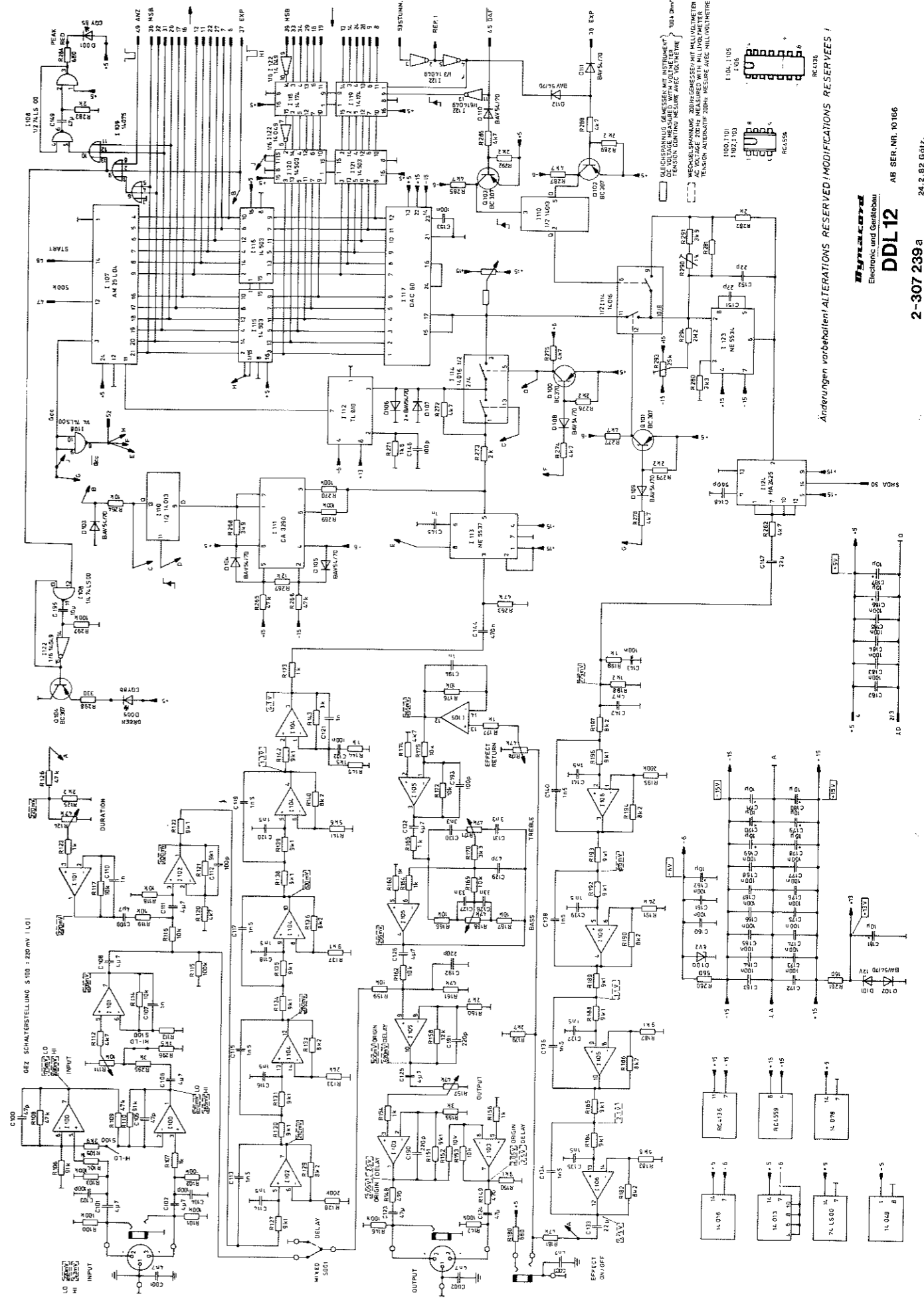

Änderungen vorbehalten! ALTERATIONS RESERVED! MODIFICATIONS RESERVEES!

DDL 12

AB SER NR. 10166

2-307 239 a

Delay Time 1000 ms

Fitting assembly MEM 13

Insert circuit board into the multipoint connector. Pay attention to the numeration 1 - 44. Secure circuit board with the screw (arrow). When operating the unit the LED-indicator (10) is lighting up, and the selected delay time is doubled.

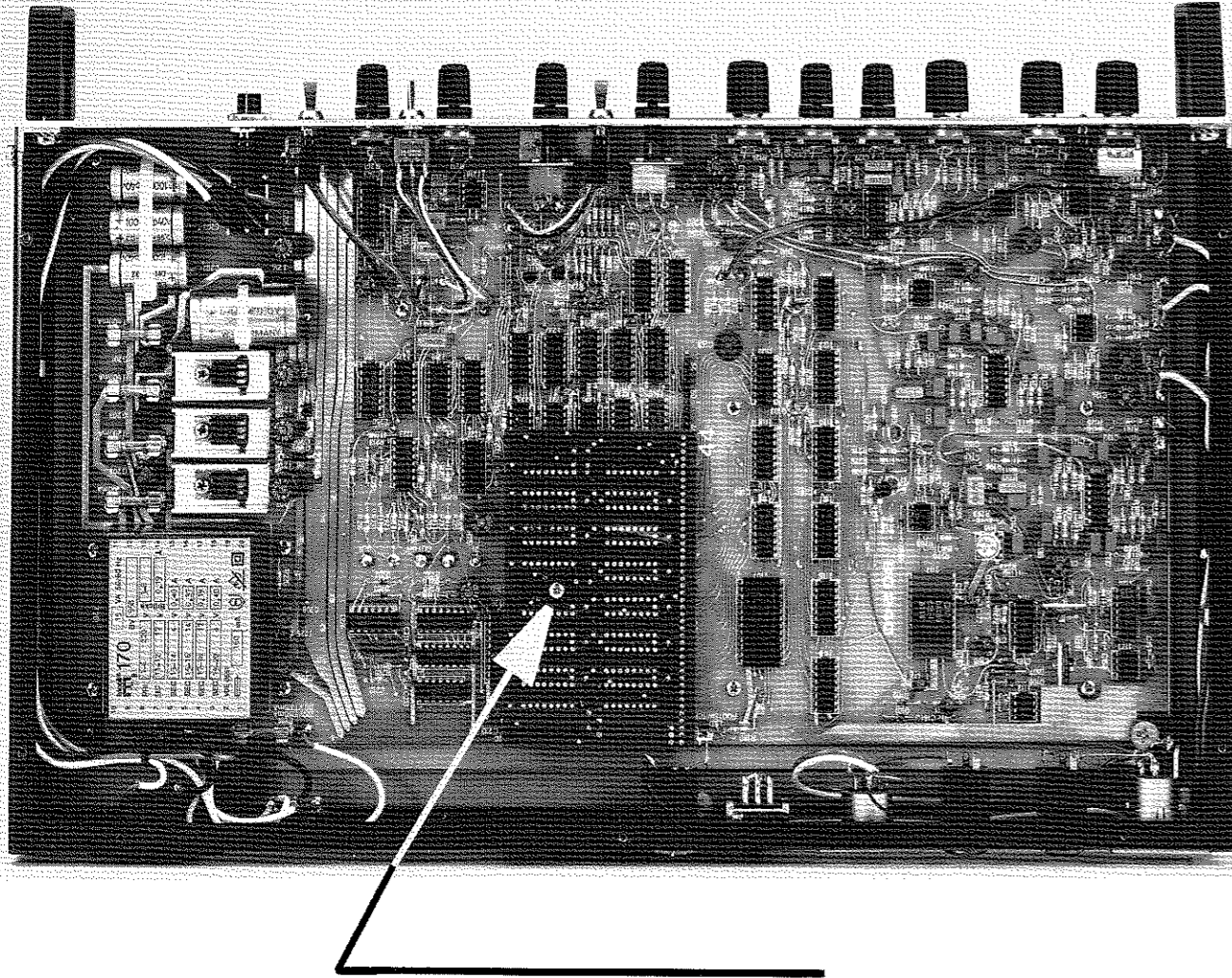

SCREW

Circuit Diagram DDL 12

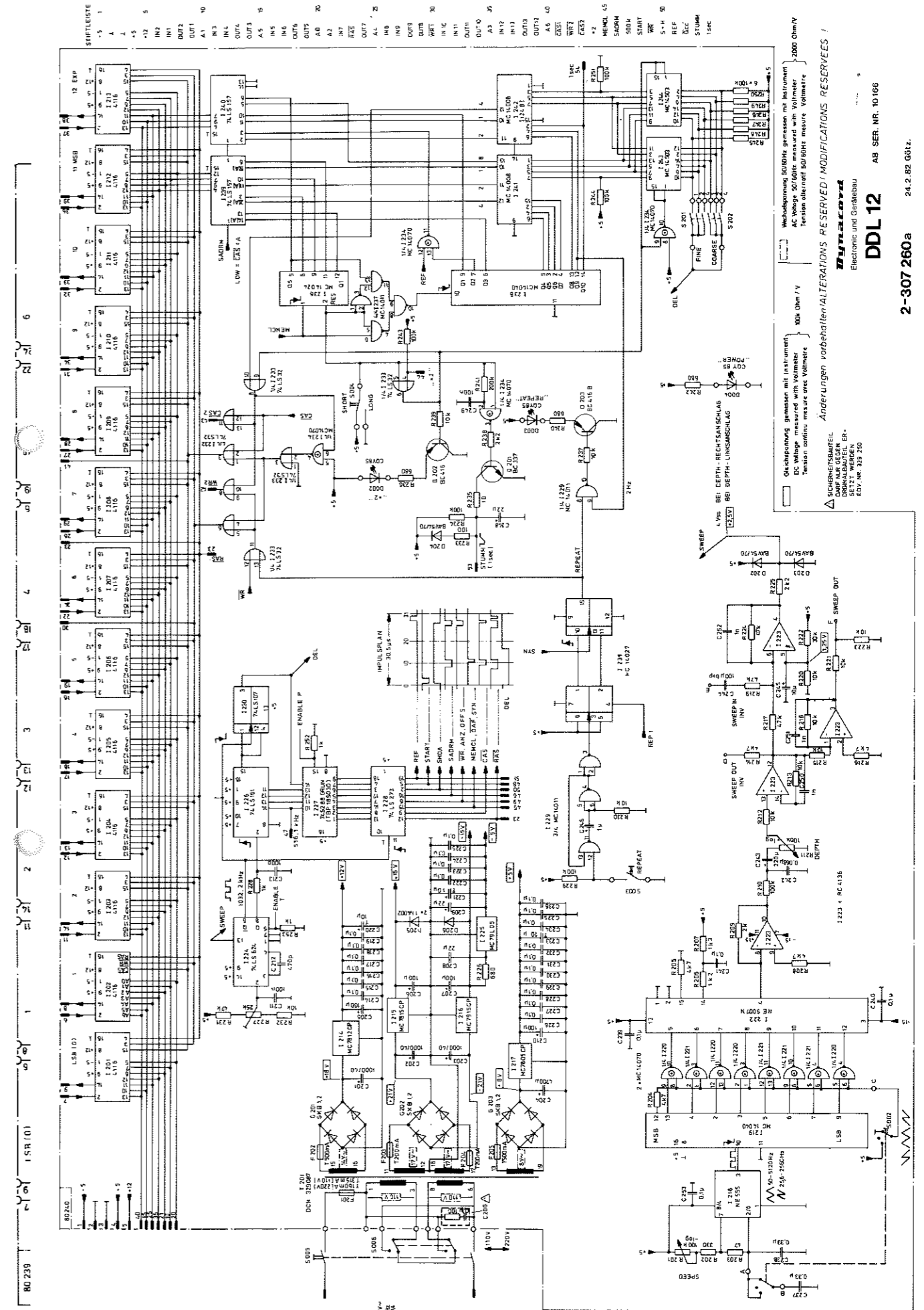

Circuit Diagram

307 277
MEM 13

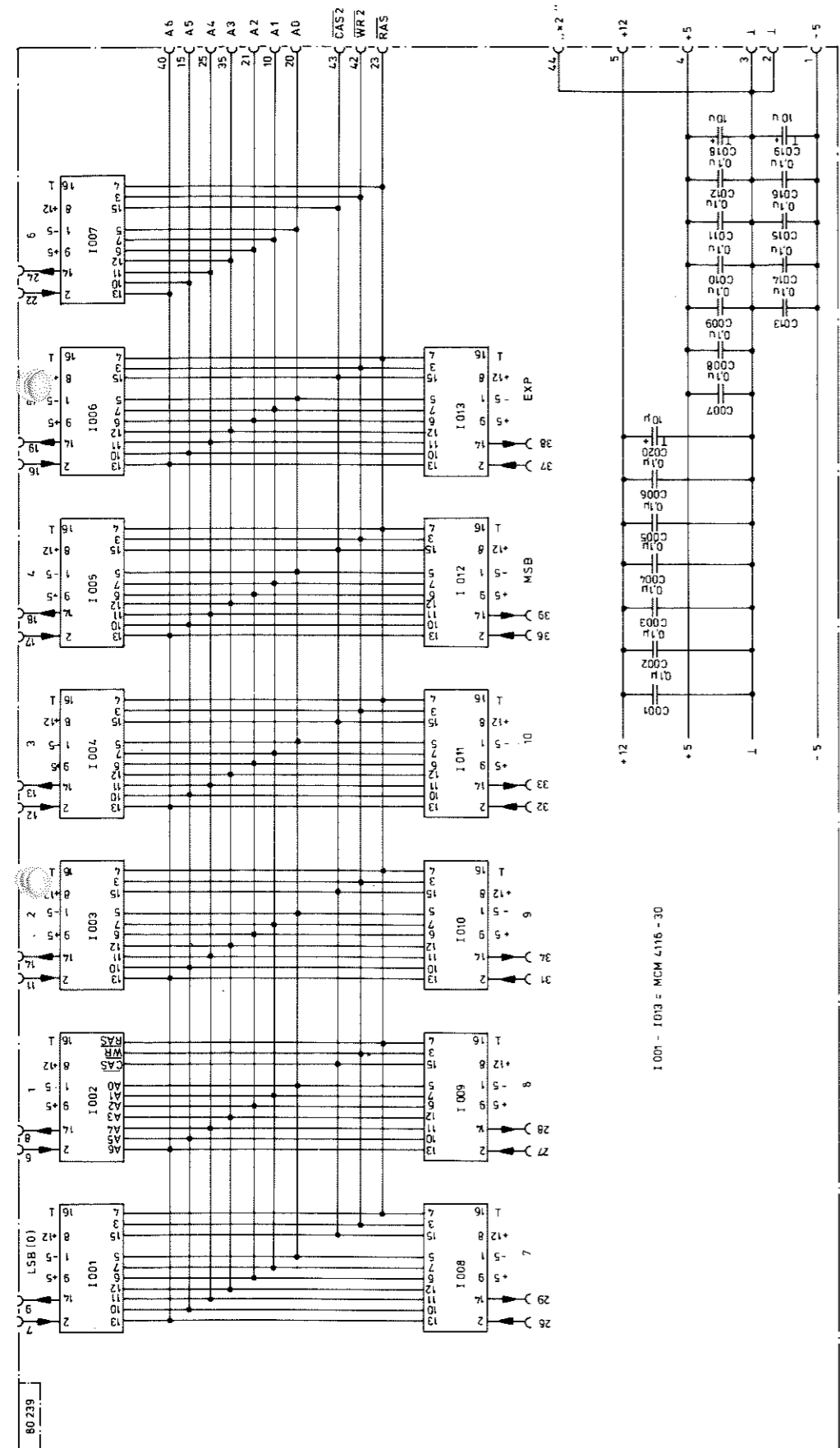

1 001 - 1013 = MCM 4116 - 30

ANSICHT VON
B - SEITE

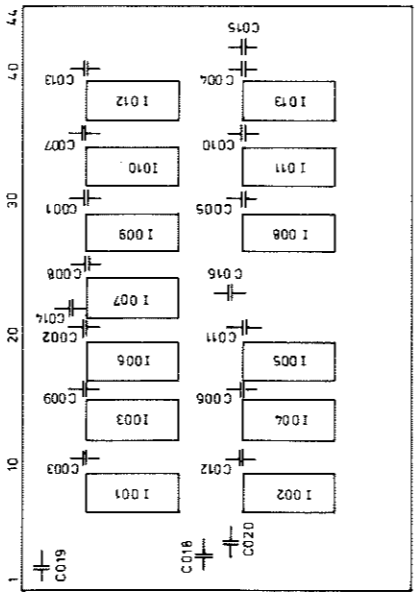

Circuit Diagram DDL 12

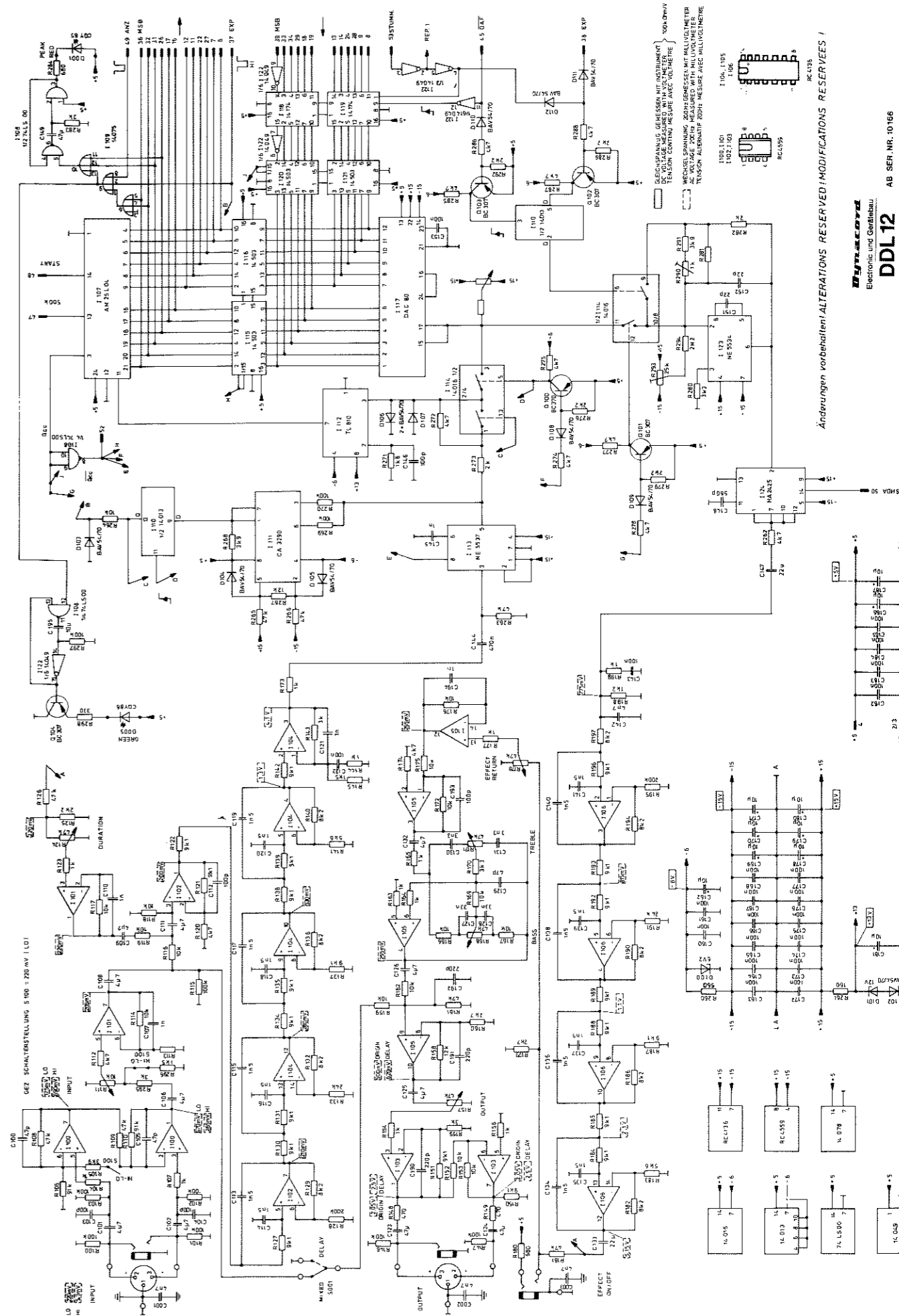

Änderungen vorbehalten! ALTERATIONS RESERVED! MODIFICATIONS RESERVEES!
Electronic und Gerätebau

DDL 12
AB SER. NR. 10166
2-307 239 a

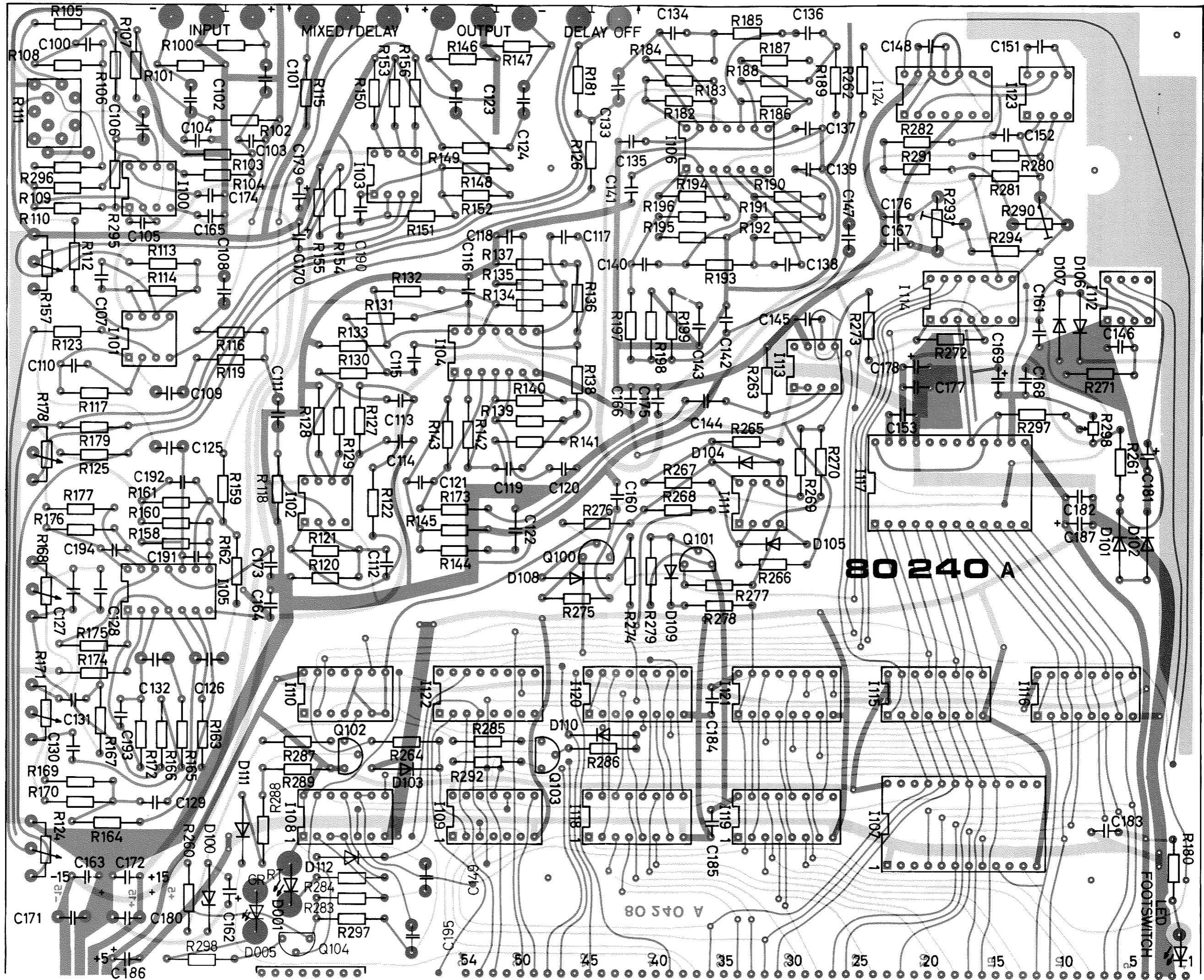

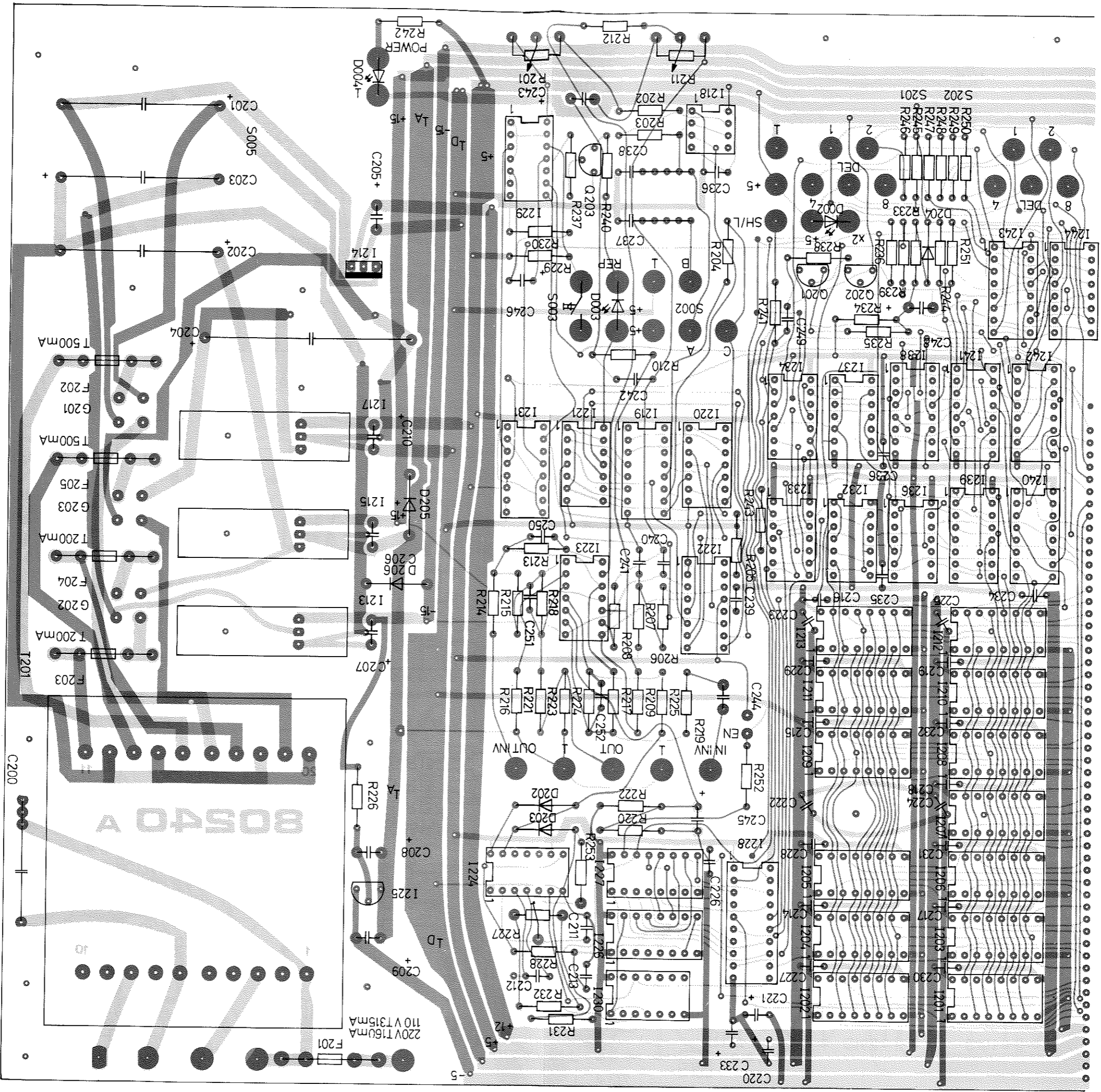

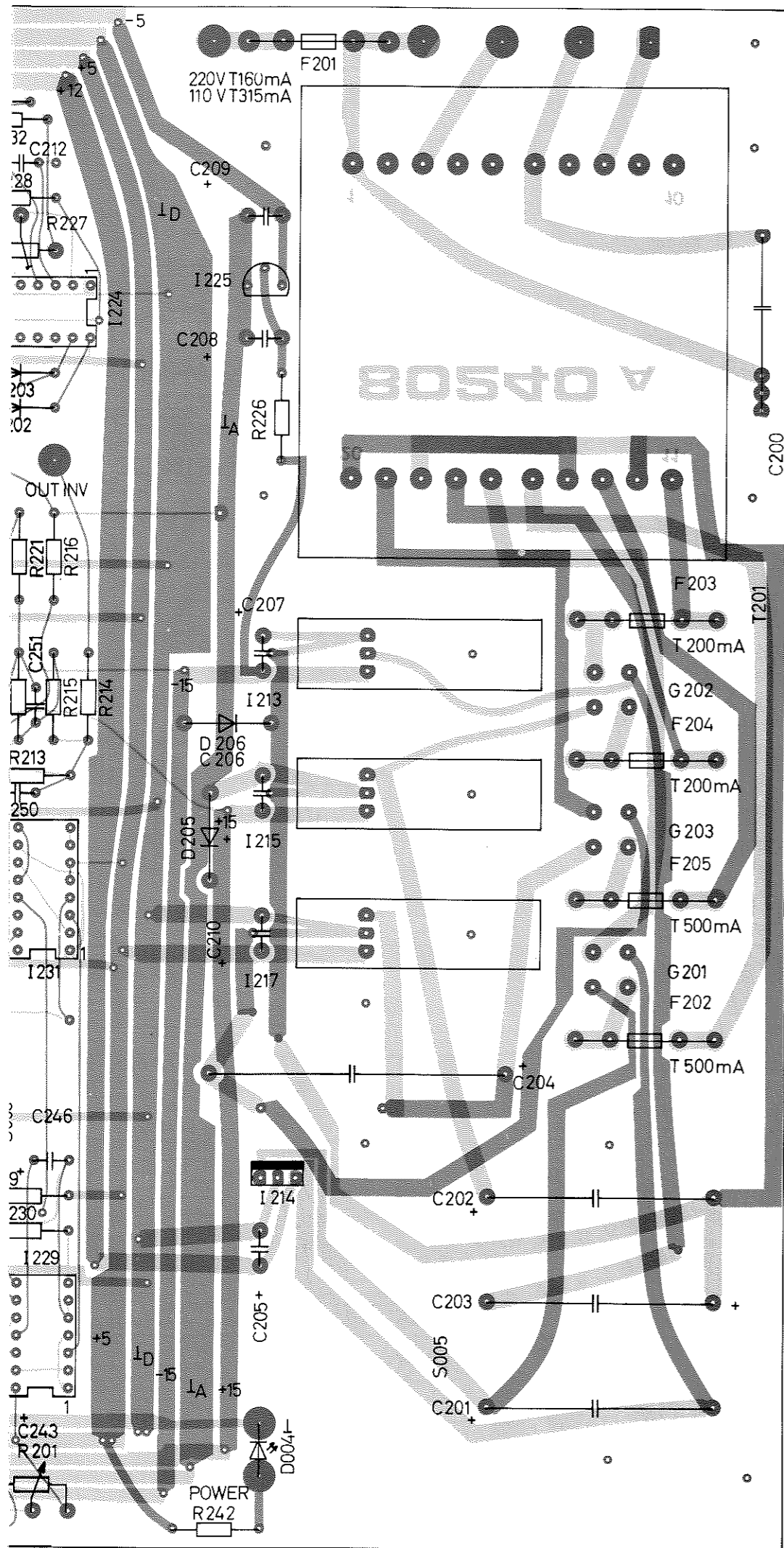

DYNACORD DIGITAL DELAY DDL 12
 =====

SERVICE - ERSATZTEILLISTE

SERVICE - LIST OF SPARE PARTS

Pos. im Schaltbild Pos. in diagram	Bezeichnung	Description	Best.-Nr. Part -No.
	Frontblende	front panel	329 577
	Griff schwarz	grip black	328 449
	Kaltgerätestecker	mains socket	327 563
	Drehknopf klein schwarz D 12	knob black D 12	326 219
	Deckel D 12	socket cover D 12	326 220
	Abdeckscheibe	top deck	326 297
	Drehknopf groß schwarz D 16	knob black D 16	327 158
	Deckel D 16	socket cover D 16	327 212
S 005	Netzschalter	mains switch	329 058
S 006	Spannungswähler	voltage selector	328 053
T 201	Netztrafo	mains transformer	329 087
G 201 - G 203	Gleichrichter	rectifier	301 203
S 003	Schalter Repeat	Repeat switch	328 953
S 002	Schalter VCO	VCO switch	328 965
S 004	Schalter Short	Short switch	328 964
S 001	Schalter Mixed-Delay	Mixed-Delay switch	303 236
S 201 - S 202	Stufenschalter Delay	Delay switch	329 088
	Stecker Switchcraft	XLR plug	306 658
	Buchse Switchcraft	XLR socket	306 464
	Buchse Koaxial	Koaxial socket	308 457

R 111	Drehpot Input	potentiometer input	309 840
R 157	Drehpot Output	potentiometer output	329 191
R 178	Drehpot Vol. Echo	potentiometer vol. echo	329 191
R 168	Drehpot Bass	potentiometer bass	329 191
R 171	Drehpot Treble	potentiometer treble	329 191
R 124	Drehpot Duration	potentiometer duration	329 191
R 211	Drehpot Depht	potentiometer depht	326 268
R 201	Drehpot Speed	potentiometer speed	329 068
I 001 - I 013	Integr. Schaltkreis MCM 4116	integrated circuit MCM 4116	309 560
I 100 - I 103	IC UFC 4559	IC UFC 4559	327 364
I 104 - I 106	IC RC 4136	IC RC 4136	308 291
I 107	IC AM 25 L 04	IC AM 25 L 04	329 096
I 108	IC SN 74 LS 00N	IC SN 74 LS 00N	309 600
I 109	IC MC 14075 BCP	IC MC 14075 BCP	329 664
I 110	IC CP 4013 BCN	IC CP 4013 BCN	300 700
I 111	IC CA 3290 E	IC CA 3290 E	329 098
I 112	IC TL 810 CP/TL	IC TL 810 CP/TL	309 723
I 113	IC NE 5537	IC NE 5537	309 561
I 114	IC MC 14016 BCP	IC MC 14016 BCP	309 712
I 115 - I 116	IC MC 14503 BCP	IC MC 14503 BCP	329 095
I 117	IC DAC 80 CBI	IC DAC 80 CBI	309 562
I 118 - I 119	IC MC 14174	IC MC 14174	329 097
I 120 - I 121	IC MC 14503 BCP	IC MC 14503 BCP	329 095
I 122	IC MC 14049 UBCP	IC MC 14049 UBCP	307 838
I 123	IC NE 5534	IC NE 5534	309 446
I 124	IC HA 1-2425-5	IC HA 1-2425-5	329 249
I 201 - I 213	IC MCM 4116	IC MCM 4116	309 560
I 214	IC UC 7812 CKC	IC UC 7812 CKC	309 720
I 215	IC MC 7815 CP	IC MC 7815 CP	308 292

I 216	IC MC 7915 CP	IC MC 7915 CP	308 293
I 217	IC MC 7805 CKC	IC MC 7805 CKC	309 719
I 218	IC NE 555 N 8	IC NE 555 N 8	309 779
I 219	IC MC 14040 BCP	IC MC 14040 BCP	329 090
I 220 - I 221	IC MC 14070 BCP	IC MC 14070 BCP	329 091
I 222	IC NE 5007 N	IC NE 5007 N	329 092
I 223	IC RC 4136 N	IC RC 4136 N	308 291
I 224	IC SN 74 LS 624 N	IC SN 74 LS 624 N	309 706
I 225	IC MC 79 L 05	IC MC 79 L 05	309 721
I 226	IC SN 74 LS 161	IC SN 74 LS 161	309 702
I 227	IC TBP 18 S 030	IC TBP 18 S 030	329 218
I 228	IC SN 74 LS 273	IC SN 74 LS 273	309 704
I 229	IC MC 14011	IC MC 14011	308 303
I 230	IC SN 74 LS 107 N	IC SN 74 LS 107 N	329 093
I 231	IC MC 14027 CP	IC MC 14027 CP	307 839
I 232 - I 233	IC SN 74 LS 32 N	IC SN 74 LS 32 N	309 698
I 234	IC MC 14070 BCP	IC MC 14070 BCP	329 091
I 236	IC MC 14024 BCP	IC MC 14024 BCP	328 781
I 237	IC MC 14011 UBCP	IC MC 14011 UBCP	308 303
I 238	IC MC 14040 BCP	IC MC 14040 BCP	329 090
I 239 - I 240	IC SN 74 LS 157 N	IC SN 74 LS 157 N	309 701
I 241 - I 242	IC MC 14008 BCP	IC MC 14008 BCP	309 094
I 243 - I 244	IC MC 14503 BCP	IC MC 14503 BCP	329 095
D 001 - D 004	LED DIODE ROT	light emitting diode red	305 311
D 005	LED DIODE GRÜN	light emitting diode green	329 845



SERVICE

SIEMENSSTR. 41 - 43
8440 STRAUBING
TEL. (0 94 21) 310 - 1

1. 1. 83